



Mounted down light series

Designing your lighting solutions



MD02 Series



KS-MD02D-A-3

Power:8W/10W
Cutout:97mm
Height:68mm

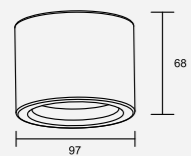

KS-MD02D-A-4

Power:12W/15W
Cutout:120mm
Height:70mm

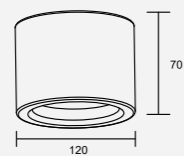

KS-MD02D-A-6

Power:15W/20W
Cutout:148mm
Height:80mm

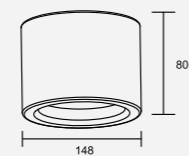

KS-MD02D-A-8

Power:20W/25W
Cutout:212mm
Height:100mm

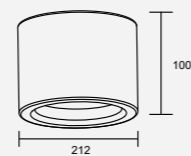

Model	KS-MD02D-A-3	KS-MD02D-A-4	KS-MD02D-A-6	KS-MD03R-A-8
Product Photo				
Dimension(mm)				
Diameter	97	120	148	212
Wattage	8W/10W	12W/15W	15W/20W	20W/25W
CCT	2700K 3000K 3500K 4000K	2700K 3000K 3500K 4000K	2700K 3000K 3500K 4000K	2700K 3000K 3500K 4000K
CRI	>90	>90	>90	>90
Beam Angle	90°	90°	90°	90°
Lumen	649-1275LM	920-1273LM	1406-2146LM	2011-2569LM
IP	IP20	IP20	IP20	IP20
Dimming	TRIAC/1-10V/DALI	TRIAC/1-10V/DALI	TRIAC/1-10V/DALI	TRIAC/1-10V/DALI
Colour	White	White	White	White

KS-MD02D-A-3

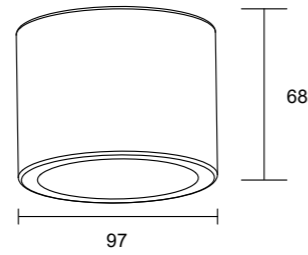
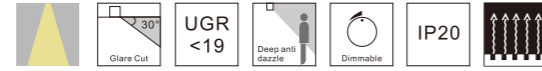

Model	Power	LED voltage	LED Current	CRI	CCT	Beam Angle	LED Output	System output	Dimming Type
KS-MD02D-A-308	8W	36V	200mA	90	2700K	90°	720lm	649lm	ON-OFF TRIAC 1-10V DALI
	8W	36V	200mA	90	3000K	90°	823lm	742lm	ON-OFF TRIAC 1-10V DALI
	8W	36V	200mA	90	4000K	90°	915lm	823lm	ON-OFF TRIAC 1-10V DALI
KS-MD02D-A-310	10W	36V	250mA	90	2700K	90°	966lm	1144lm	ON-OFF TRIAC 1-10V DALI
	10W	36V	250mA	90	3000K	90°	1014lm	1201lm	ON-OFF TRIAC 1-10V DALI
	10W	36V	250mA	90	4000K	90°	1077lm	1275lm	ON-OFF TRIAC 1-10V DALI

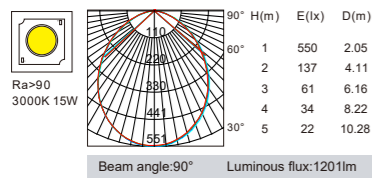

KS-MD02D-A-4

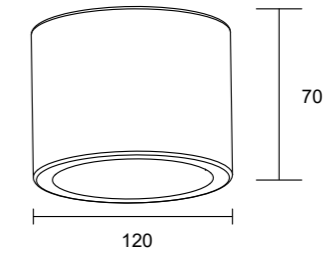
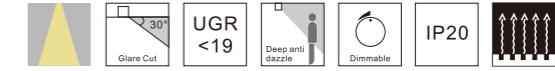

Model	Power	LED voltage	LED Current	CRI	CCT	Beam Angle	LED Output	System output	Dimming Type
KS-MD02D-A-412	12W	36V	300mA	90	2700K	90°	634lm	920lm	ON-OFF TRIAC 1-10V DALI
	12W	36V	300mA	90	3000K	90°	723lm	1050lm	ON-OFF TRIAC 1-10V DALI
	12W	36V	300mA	90	4000K	90°	815lm	1183lm	ON-OFF TRIAC 1-10V DALI
KS-MD02D-A-415	15W	36V	350mA	90	2700K	90°	1314lm	1141lm	ON-OFF TRIAC 1-10V DALI
	15W	36V	350mA	90	3000K	90°	1383lm	1201lm	ON-OFF TRIAC 1-10V DALI
	15W	36V	350mA	90	4000K	90°	1467lm	1273lm	ON-OFF TRIAC 1-10V DALI

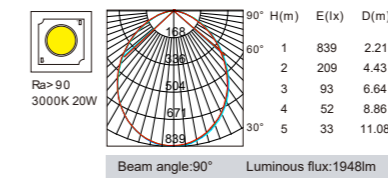
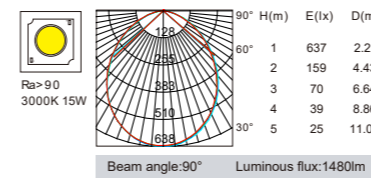

KS-MD02D-A-6

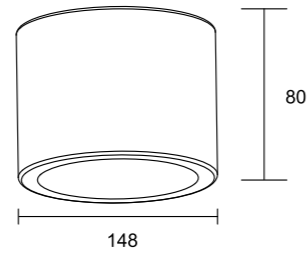
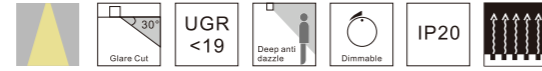

Model	Power	LED voltage	LED Current	CRI	CCT	Beam Angle	LED Output	System output	Dimming Type
KS-MD02D-A-615	15W	36V	500mA	90	2700K	90	1877lm	1406lm	ON-OFF TRIAC 1-10V DALI
	15W	36V	500mA	90	3000K	90	1975lm	1480lm	ON-OFF TRIAC 1-10V DALI
	15W	36V	500mA	90	4000K	90	2095lm	1633lm	ON-OFF TRIAC 1-10V DALI
KS-MD02D-A-620	20W	36V	600mA	90	2700K	90	2452lm	1842lm	ON-OFF TRIAC 1-10V DALI
	20W	36V	600mA	90	3000K	90	2593lm	1948lm	ON-OFF TRIAC 1-10V DALI
	20W	36V	600mA	90	4000K	90	2805lm	2146lm	ON-OFF TRIAC 1-10V DALI

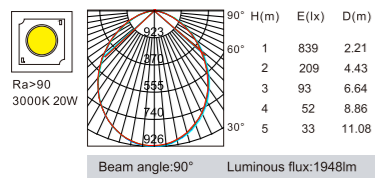

KS-MD02D-A-8

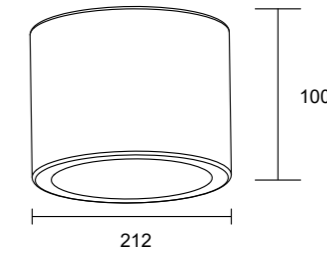

Model	Power	LED voltage	LED Current	CRI	CCT	Beam Angle	LED Output	System output	Dimming Type
KS-MD02D-A-820	20W	36V	500mA	90	2700K	90	1877lm	2011lm	ON-OFF TRIAC 1-10V DALI
	20W	36V	500mA	90	3000K	90	1975lm	2116lm	ON-OFF TRIAC 1-10V DALI
	20W	36V	500mA	90	4000K	90	2095lm	2244lm	ON-OFF TRIAC 1-10V DALI
KS-MD02D-A-825	25W	36V	600mA	90	2700K	90	2452lm	2245lm	ON-OFF TRIAC 1-10V DALI
	25W	36V	600mA	90	3000K	90	2593lm	2375lm	ON-OFF TRIAC 1-10V DALI
	25W	36V	600mA	90	4000K	90	2805lm	2569lm	ON-OFF TRIAC 1-10V DALI

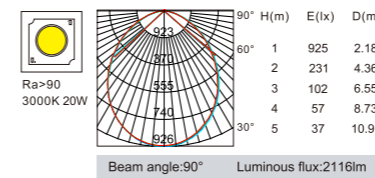

MD02 Series



KS-MD02R-A-3

Power:10W
Cutout:74mm
Height:130mm

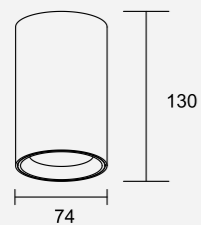

KS-MD02R-A-4

Power:12W/15W
Cutout:93mm
Height:150mm

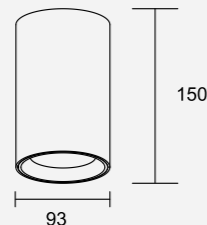

KS-MD02R-A-5

Power:15W/20W
Cutout:114mm
Height:160mm

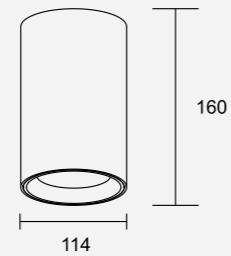

KS-MD02R-A-6

Power:20W/25W
Cutout:141mm
Height:160mm

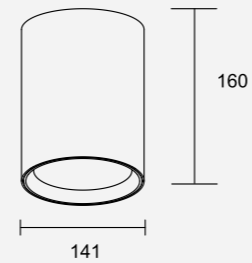

Model	KS-MD02R-A-3	KS-MD02R-A-4	KS-MD02R-A-5	KS-MD02R-A-6
Product Photo				
Dimension(mm)				
Diameter	97	120	148	212
Wattage	8W	12W/15W	15W/20W	20W/25W
CCT	2700K 3000K 3500K 4000K	2700K 3000K 3500K 4000K	2700K 3000K 3500K 4000K	2700K 3000K 3500K 4000K
CRI	>90	>90	>90	>90
Beam Angle	36°	36°	36°	36°
Lumen	1144-1275LM	1079-1751LM	1673-2624LM	2295-3024LM
IP	IP20	IP20	IP20	IP20
Dimming	TRIAC/1-10V/DALI	TRIAC/1-10V/DALI	TRIAC/1-10V/DALI	TRIAC/1-10V/DALI
Colour	White	White	White	White

KS-MD02R-A-3

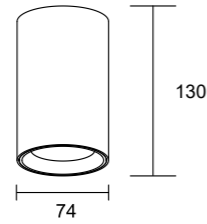
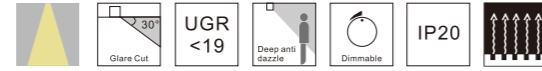

Model	Power	LED voltage	LED Current	CRI	CCT	Beam Angle	LED Output	System output	Dimming Type
KS-MD02R-A-310	10W	36V	250mA	90	2700K	36°	1144lm	966lm	ON-OFF TRIAC 1-10V DALI
	10W	36V	250mA	90	3000K	36°	1201lm	1014lm	ON-OFF TRIAC 1-10V DALI
	10W	36V	250mA	90	4000K	36°	1275lm	1077lm	ON-OFF TRIAC 1-10V DALI

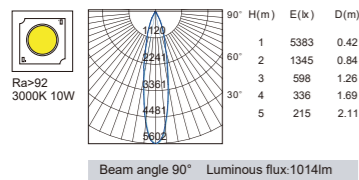

KS-MD02R-A-4

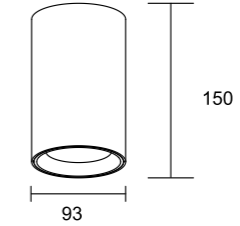
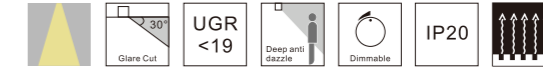

Model	Power	LED voltage	LED Current	CRI	CCT	Beam Angle	LED Output	System output	Dimming Type
KS-MD02R-A-412	12W	36V	300mA	90	2700K	36°	1079lm	634lm	ON-OFF TRIAC 1-10V DALI
	12W	36V	300mA	90	3000K	36°	1231lm	723lm	ON-OFF TRIAC 1-10V DALI
	12W	36V	300mA	90	4000K	36°	1387lm	815lm	ON-OFF TRIAC 1-10V DALI
KS-MD02R-A-415	15W	36V	350mA	90	2700K	36°	1568lm	1314lm	ON-OFF TRIAC 1-10V DALI
	15W	36V	350mA	90	3000K	36°	1651lm	1383lm	ON-OFF TRIAC 1-10V DALI
	15W	36V	350mA	90	4000K	36°	1751lm	1467lm	ON-OFF TRIAC 1-10V DALI

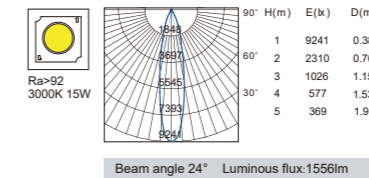
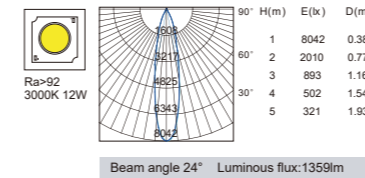

KS-MD02R-A-5

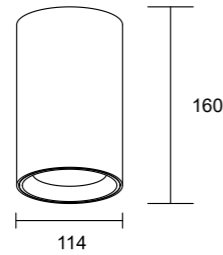
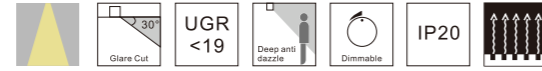

Model	Power	LED voltage	LED Current	CRI	CCT	Beam Angle	LED Output	System output	Dimming Type
KS-MD02R-A-515	15W	36V	400mA	90	2700K	50°	1673lm	1314lm	ON-OFF TRIAC 1-10V DALI
	15W	36V	400mA	90	3000K	50°	1761lm	1383lm	ON-OFF TRIAC 1-10V DALI
	15W	36V	400mA	90	4000K	50°	1867lm	1467lm	ON-OFF TRIAC 1-10V DALI
KS-MD02R-A-520	20W	36V	500mA	90	2700K	50°	2351lm	1877lm	ON-OFF TRIAC 1-10V DALI
	20W	36V	500mA	90	3000K	50°	2474lm	1975lm	ON-OFF TRIAC 1-10V DALI
	20W	36V	500mA	90	4000K	50°	2624lm	2095lm	ON-OFF TRIAC 1-10V DALI

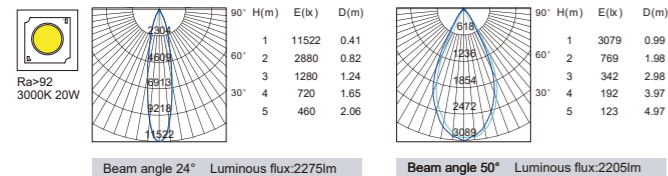

KS-MD02R-A-6

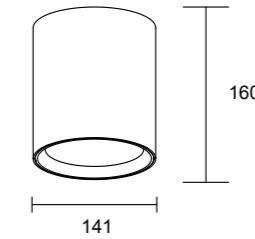

Model	Power	LED voltage	LED Current	CRI	CCT	Beam Angle	LED Output	System output	Dimming Type
KS-MD02R-A-620	20W	36V	500mA	90	2700K	50°	2295lm	1877lm	ON-OFF TRIAC 1-10V DALI
	20W	36V	500mA	90	3000K	50°	2415lm	1975lm	ON-OFF TRIAC 1-10V DALI
	20W	36V	500mA	90	4000K	50°	2561lm	2095lm	ON-OFF TRIAC 1-10V DALI
KS-MD02R-A-625	25W	36V	600mA	90	2700K	50°	2643lm	2452lm	ON-OFF TRIAC 1-10V DALI
	25W	36V	600mA	90	3000K	50°	2796lm	2593lm	ON-OFF TRIAC 1-10V DALI
	25W	36V	600mA	90	4000K	50°	3024lm	2805lm	ON-OFF TRIAC 1-10V DALI

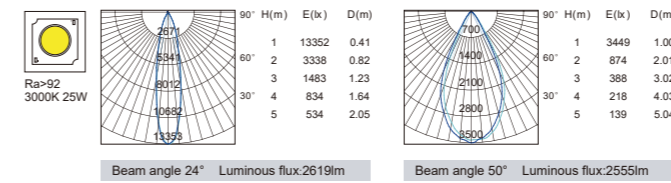

MD03 Series



KAS-MD03R-A-4

Power:15W/20W
Cutout:100*100mm
Height:145mm

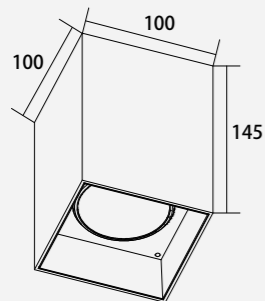

KAS-MD03R-A-4

Power:25W
Cutout:100*100mm
Height:145mm

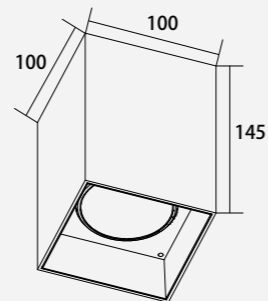

Model	KAS-MD03R-A-4	KAS-MD03R-A-4
Product Photo		
Dimension(mm)		
Diameter	100*100	100*100
Wattage	15W/20W	25W
CCT	2700K 3000K 3500K 4000K	2700K 3000K 3500K 4000K
CRI	>90	>90
Beam Angle	15° /24° /30° /36° /60°	15° /20° /30° /36° /60°
Lumen	926-1572LM	1571-1805LM
IP	IP20	IP20
Dimming	TRIAC/1-10V/DALI	TRIAC/1-10V/DALI
Colour	White	White

KAS-MD03R-A-4

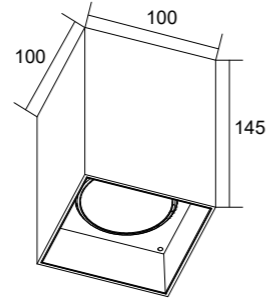
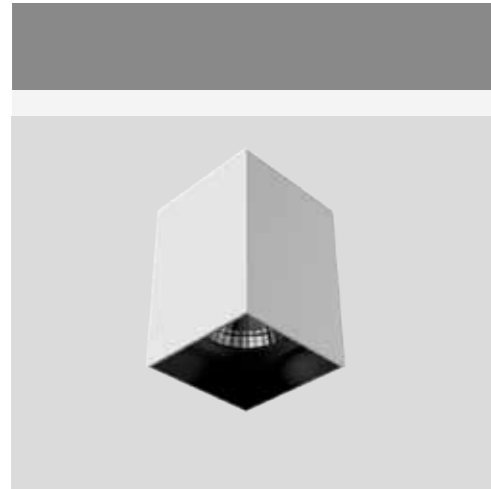

Model	Power	LED voltage	LED Current	CRI	CCT	Beam Angle	LED Output	System output	Dimming Type
KAS-MD03R-A-415	15W	36V	350mA	90	2700K	15°	1314lm	1039lm	ON-OFF TRIAC 1-10V DALI
						24°	1314lm	946lm	
						30°	1314lm	991lm	
						36°	1314lm	926lm	
						60°	1314lm	996lm	
	15W	36V	350mA	90	3000K	15°	1383lm	1097lm	ON-OFF TRIAC 1-10V DALI
						24°	1383lm	996lm	
						30°	1383lm	1044lm	
						36°	1383lm	975lm	
						60°	1383lm	1049lm	
	15W	36V	350mA	90	4000K	15°	1467lm	1163lm	ON-OFF TRIAC 1-10V DALI
						24°	1467lm	1056lm	
30°						1467lm	1107lm		
36°						1467lm	1034lm		
60°						1467lm	1112lm		
KAS-MD03R-A-420	20W	36V	500mA	90	2700K	15°	1877lm	1408lm	ON-OFF TRIAC 1-10V DALI
						24°	1877lm	1279lm	
						30°	1877lm	1337lm	
						36°	1877lm	1251lm	
						60°	1877lm	1347lm	
	20W	36V	500mA	90	3000K	15°	1975lm	1482lm	ON-OFF TRIAC 1-10V DALI
						24°	1975lm	1346lm	
						30°	1975lm	1407lm	
						36°	1975lm	1317lm	
						60°	1975lm	1418lm	
	20W	36V	500mA	90	4000K	15°	2095lm	1572lm	ON-OFF TRIAC 1-10V DALI
						24°	2095lm	1427lm	
30°						2095lm	1110lm		
36°						2095lm	1397lm		
60°						2095lm	1504lm		

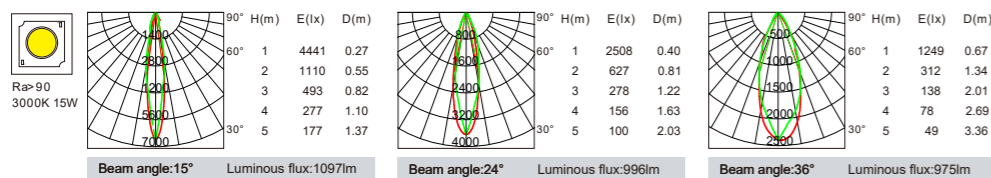

KAS-MD03R-A-4

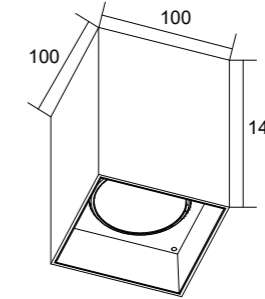
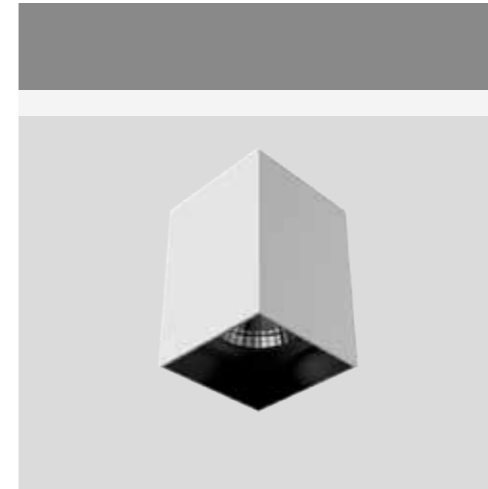

Model	Power	LED voltage	LED Current	CRI	CCT	Beam Angle	LED Output	System output	Dimming Type
KAS-MD03R-A-425	25W	36V	600mA	90	2700K	20°	2452lm	1571lm	ON-OFF TRIAC 1-10V DALI
						30°	2452lm	1573lm	
						36°	2452lm	1578lm	
						45°	2452lm	1565lm	
						20°	2593lm	1662lm	
	25W	36V	600mA	90	3000K	30°	2593lm	1664lm	ON-OFF TRIAC 1-10V DALI
						36°	2593lm	1669lm	
						45°	2593lm	1656lm	
						20°	2805lm	1797lm	
						30°	2805lm	1800lm	
	25W	36V	600mA	90	4000K	36°	2805lm	1805lm	ON-OFF TRIAC 1-10V DALI
						45°	2805lm	1791lm	

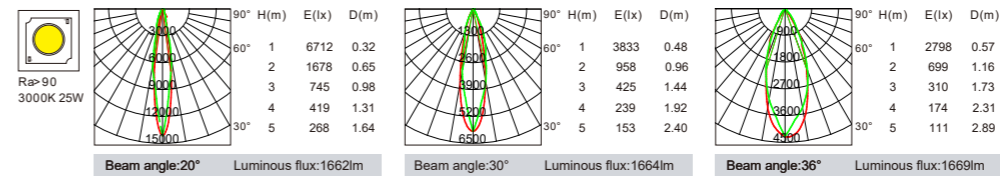



New MD07 Series



MD07 Series Mounted Downlight

Simple but exquisite, Kam's mounted downlight combines aesthetic features and performance. A variety of choices and customized services depending on your requirements.

New MD07 Series



KS-MD07R-A-3
Power: 8W/10W
Diameter: 75mm
Height: 115mm

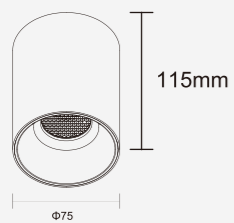

KS-MD07R-A-4
Power: 12W/15W
Diameter: 95mm
Height: 120mm

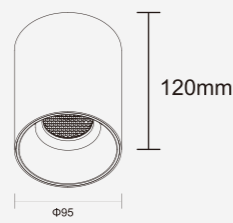

KS-MD07R-A-5
Power: 20W/25W
Diameter: 120mm
Height: 142mm

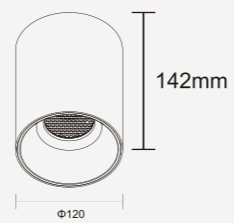



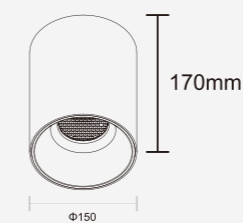

KS-MD07R-A-6
Power: 25W/30W/35W
Diameter: 150mm
Height: 170mm

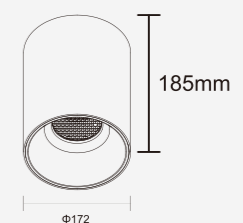

KS-MD07R-A-8
Power: 35W/40W
Diameter: 185mm
Height: 172mm

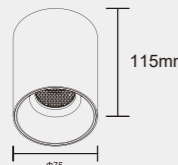
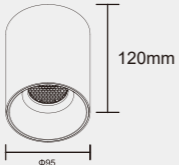
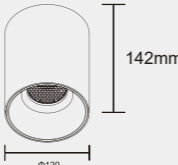
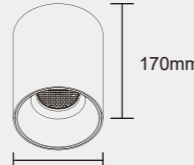
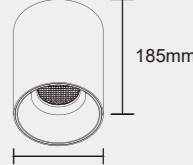

New MD07 Series

Model	KS-MD07R-A-308	KS-MD07R-A-412	KS-MD07R-A-520		KS-MD07R-A-625	KS-MD07R-A-835
Product Photo						
Dimension(mm)						
Diameter	75	95	120		150	185
Wattage	8W/10W	12W/15W	20W/25W		25W/30W/35W	35W/40W
CCT	2700K 3000K 3500K 4000K	2700K 3000K 3500K 4000K	2700K 3000K 3500K 4000K		2700K 3000K 3500K 4000K	2700K 3000K 3500K 4000K
CRI	>90	>90	>90		>90	>90
Beam Angle	24°/50°	24°/50°	24°/50°		24°/50°	24°/50°
Lumen	820-996LM	1306-1547LM	2173-2696LM		2211-3401LM	2574-3898LM
IP	IP65/54	IP65/54	IP65/54		IP65/54	IP65/54
Dimming	TRIAC/1-10V/DALI	TRIAC/1-10V/DALI	TRIAC/1-10V/DALI		TRIAC/1-10V/DALI	TRIAC/1-10V/DALI
Colour	White+Black	White+Black	White+Black		White+Black	White+Black

KS-MD07R-A-3

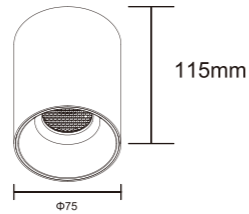
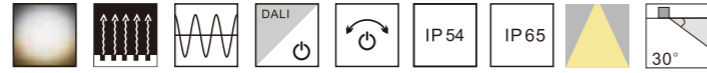

Model	Power	LED voltage	LED Current	CRI	CCT	Beam Angle	LED Output	System output	Dimming Type
KAS-MD07R-A-308	8W	34V	200mA	90	2700K	24° 50°	972lm 972lm	820lm 736lm	ON-OFF TRIAC 1-10V DALI
	8W	34V	200mA	90	3000K	24° 50°	1018lm 1018lm	859lm 771lm	ON-OFF TRIAC 1-10V DALI
	8W	34V	200mA	90	4000K	24° 50°	1065lm 1065lm	898lm 806lm	ON-OFF TRIAC 1-10V DALI
KAS-MD07R-A-310	10W	34V	250mA	90	2700K	24° 50°	1160lm 1160lm	1001lm 898lm	ON-OFF TRIAC 1-10V DALI
	10W	34V	250mA	90	3000K	24° 50°	1220lm 1220lm	1053lm 945lm	ON-OFF TRIAC 1-10V DALI
	10W	34V	250mA	90	4000K	24° 50°	1286lm 1286lm	1109lm 996lm	ON-OFF TRIAC 1-10V DALI

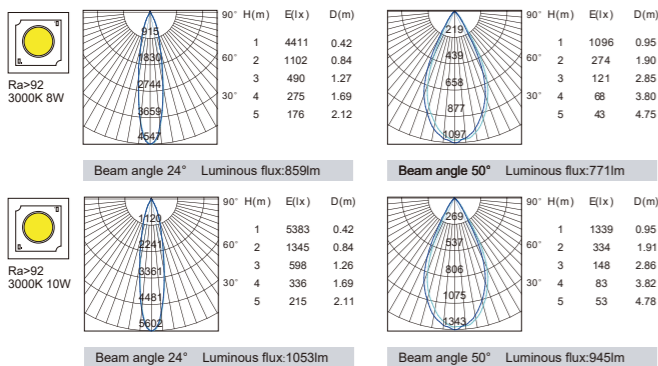

KS-MD07R-A-4

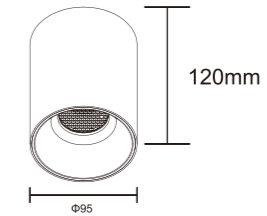
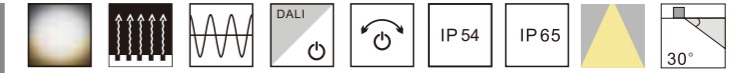

Model	Power	LED voltage	LED Current	CRI	CCT	Beam Angle	LED Output	System output	Dimming Type
KAS-MD07R-A-412	12W	34V	300mA	90	2700K	24° 50°	1425lm 1425lm	1304lm 1213lm	ON-OFF TRIAC 1-10V DALI
	12W	34V	300mA	90	3000K	24° 50°	1485lm 1485lm	1359lm 1265lm	ON-OFF TRIAC 1-10V DALI
	12W	34V	300mA	90	4000K	24° 50°	1558lm 1558lm	1425lm 1327lm	ON-OFF TRIAC 1-10V DALI
KAS-MD07R-A-415	15W	34V	350mA	90	2700K	24° 50°	1613lm 1613lm	1491lm 1412lm	ON-OFF TRIAC 1-10V DALI
	15W	34V	350mA	90	3000K	24° 50°	1683lm 1683lm	1556lm 1474lm	ON-OFF TRIAC 1-10V DALI
	15W	34V	350mA	90	4000K	24° 50°	1767lm 1767lm	1633lm 1547lm	ON-OFF TRIAC 1-10V DALI

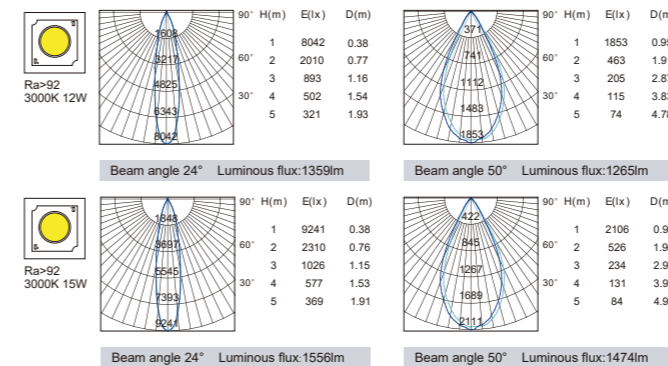

KS-MD07R-A-5

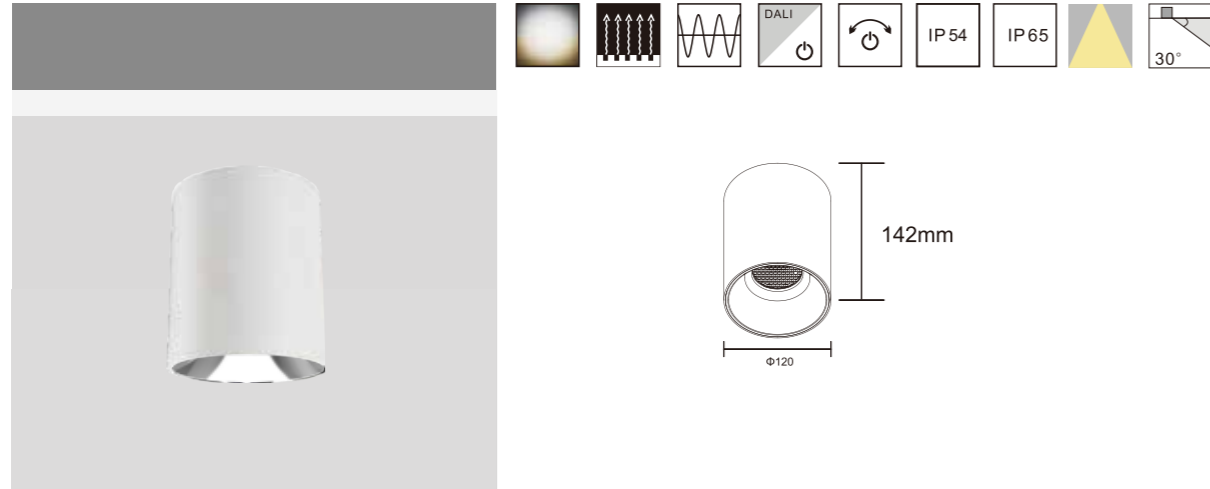

Model	Power	LED voltage	LED Current	CRI	CCT	Beam Angle	LED Output	System output	Dimming Type
KAS-MD07R-A-520	20W	34V	500mA	90	2700K	24° 50°	2255lm 2255lm	2173lm 2106lm	ON-OFF TRIAC 1-10V DALI
	20W	34V	500mA	90	3000K	24° 50°	2360lm 2360lm	2275lm 2205lm	ON-OFF TRIAC 1-10V DALI
	20W	34V	500mA	90	4000K	24° 50°	2482lm 2482lm	2392lm 2318lm	ON-OFF TRIAC 1-10V DALI
KAS-MD07R-A-525	25W	34V	700mA	90	2700K	24° 50°	2650lm 2650lm	2505m 2444lm	ON-OFF TRIAC 1-10V DALI
	25W	34V	700mA	90	3000K	24° 50°	2770lm 2770m	2619lm 2555lm	ON-OFF TRIAC 1-10V DALI
	25W	34V	700mA	90	4000K	24° 50°	2923lm 2923lm	2763lm 2696lm	ON-OFF TRIAC 1-10V DALI

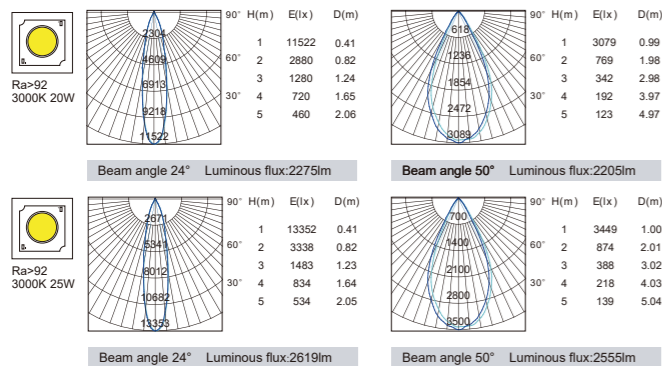

KS-MD07R-A-6

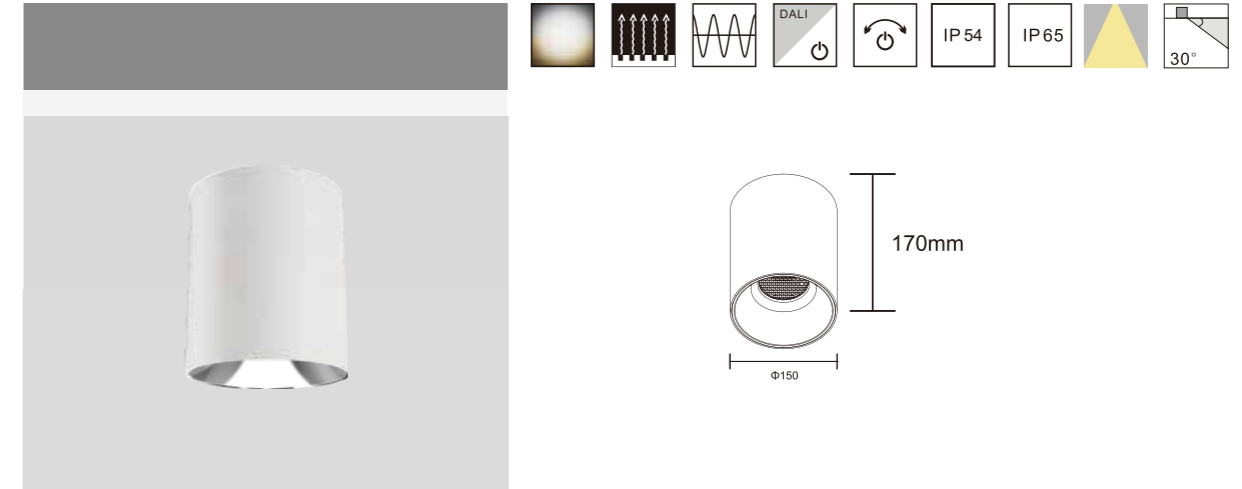

Model	Power	LED voltage	LED Current	CRI	CCT	Beam Angle	LED Output	System output	Dimming Type
KAS-MD07R-A-625	25W	34V	700mA	90	2700K	24° 50°	2750lm 2750lm	2574lm 2485lm	ON-OFF TRIAC 1-10V DALI
	25W	34V	700mA	90	3000K	24° 50°	2871lm 2871lm	2688lm 2595lm	ON-OFF TRIAC 1-10V DALI
	25W	34V	700mA	90	4000K	24° 50°	3020lm 3020lm	2827lm 2729lm	ON-OFF TRIAC 1-10V DALI
KAS-MD07R-A-630	30W	34V	800mA	90	2700K	24° 50°	3188lm 3188lm	2937lm 2821lm	ON-OFF TRIAC 1-10V DALI
	30W	34V	800mA	90	3000K	24° 50°	3291lm 3291lm	3032lm 2913lm	ON-OFF TRIAC 1-10V DALI
	30W	34V	800mA	90	4000K	24° 50°	3416lm 3416lm	3147lm 3023lm	ON-OFF TRIAC 1-10V DALI
KAS-MD07R-A-635	35W	34V	1000mA	90	2700K	24° 50°	3861lm 3861lm	3705lm 3589lm	ON-OFF TRIAC 1-10V DALI
	35W	34V	1000mA	90	3000K	24° 50°	3996lm 3996lm	3835lm 3715lm	ON-OFF TRIAC 1-10V DALI
	35W	34V	1000mA	90	4000K	24° 50°	4193lm 4193lm	4024lm 3898lm	ON-OFF TRIAC 1-10V DALI

KS-MD07R-A-8

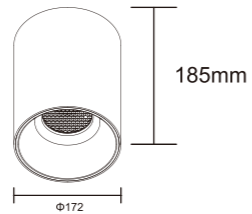
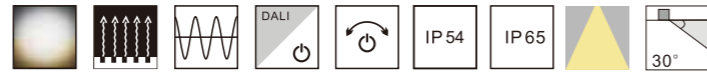

Model	Power	LED voltage	LED Current	CRI	CCT	Beam Angle	LED Output	System output	Dimming Type
KAS-MD07R-A-835	35W	36V	800mA	90	2700K	24° 50°	2420lm 2420lm	2211lm 2244lm	ON-OFF TRIAC 1-10V DALI
	35W	36V	800mA	90	3000K	24° 50°	2720lm 2720lm	2486lm 2523lm	ON-OFF TRIAC 1-10V DALI
	35W	36V	800mA	90	4000K	24° 50°	3080lm 3080lm	2815lm 2856lm	ON-OFF TRIAC 1-10V DALI
KAS-MD07R-A-840	40W	36V	1000mA	90	2700K	24° 50°	2924lm 2924lm	2553lm 2624lm	ON-OFF TRIAC 1-10V DALI
	40W	36V	1000mA	90	3000K	24° 50°	3330lm 3330lm	2908lm 2989lm	ON-OFF TRIAC 1-10V DALI
	40W	36V	1000mA	90	4000K	24° 50°	3790lm 3790lm	3309lm 3401lm	ON-OFF TRIAC 1-10V DALI

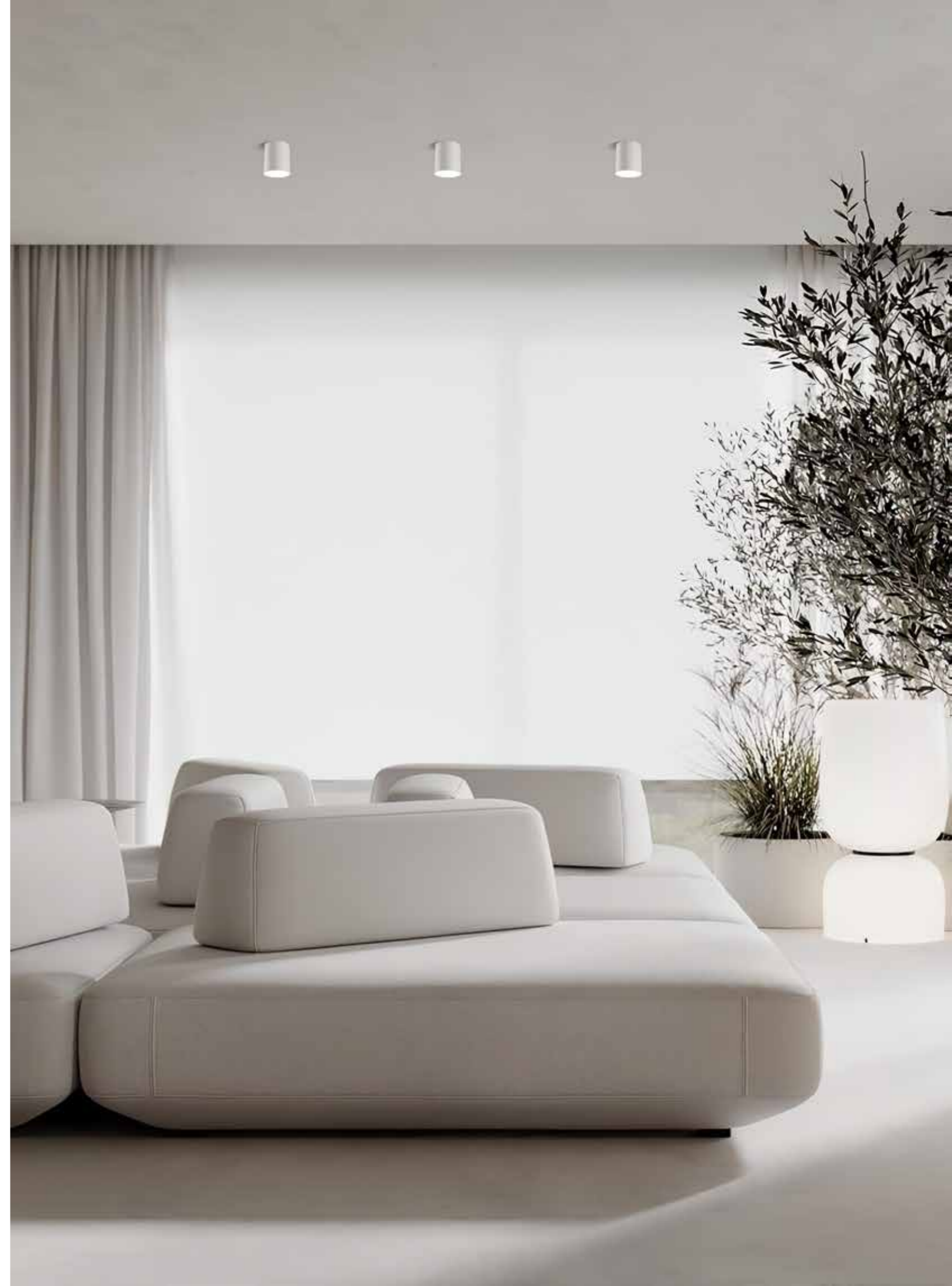
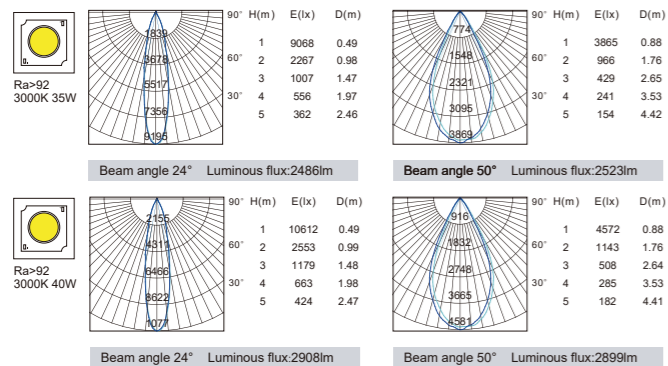

MD15 Series



KS-MD15R-A-3

Power:10W/15W
Cutout:90mm
Height:120mm

KS-MD15R-A-4

Power:15W/20W
Cutout:110mm
Height:145mm

KS-MD15R-A-5

Power:25W/30W/35W
Cutout:140mm
Height:170mm

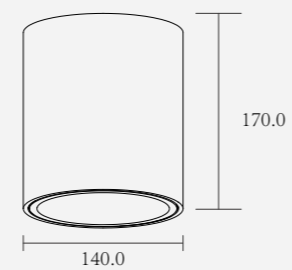
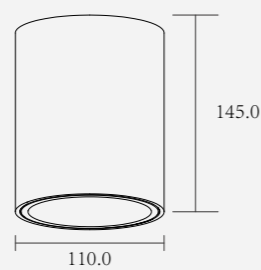
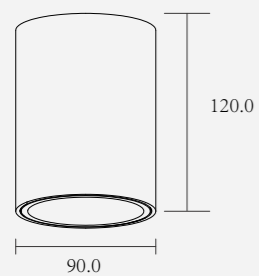

Model	KS-MD15R-A-3	KS-MD15R-A-4	KS-MD15R-A-5
Product Photo			
Dimension(mm)			
Diameter	90	110	140
Wattage	10W/15W	15W/20W	25W/30W/35W
CCT	2700K 3000K 3500K 4000K	2700K 3000K 3500K 4000K	2700K 3000K 3500K 4000K
CRI	>90	>90	>90
Beam Angle	30°/50°	30°/60°	30°/60°
Lumen	686-1311LM	1081-1872LM	1921-1080LM
IP	IP54/IP65	IP54/IP65	IP54/IP65
Dimming	TRIAC/1-10V/DALI	TRIAC/1-10V/DALI	TRIAC/1-10V/DALI
Colour	White/Black	White/Black	White/Black

KS-MD15R-A-3

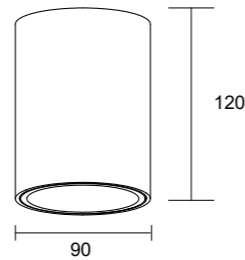

Model	Power	LED voltage	LED Current	CRI	CCT	Beam Angle	LED Output	System output	Dimming Type
KS-MD15R-A-310	10W	36V	250mA	90	2700K	30° 50°	966lm 966lm	686lm 927lm	ON-OFF TRIAC 1-10V DALI
	10W	36V	250mA	90	3000K	30° 50°	1014lm 1014lm	934lm 974lm	ON-OFF TRIAC 1-10V DALI
	10W	36V	250mA	90	4000K	30° 50°	1077lm 1077lm	992lm 1034lm	ON-OFF TRIAC 1-10V DALI
KS-MD15R-A-315	15W	36V	350mA	90	2700K	30° 50°	1314lm 1314lm	1136lm 1174lm	ON-OFF TRIAC 1-10V DALI
	15W	36V	350mA	90	3000K	30° 50°	1383lm 1383lm	1196lm 1236lm	ON-OFF TRIAC 1-10V DALI
	15W	36V	350mA	90	4000K	30° 50°	1467lm 1467lm	1268lm 1311lm	ON-OFF TRIAC 1-10V DALI

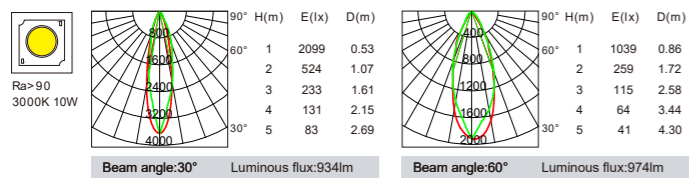

KS-MD15R-A-4

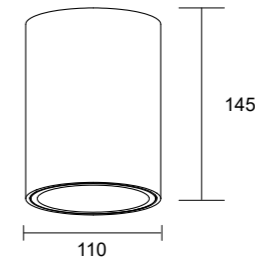
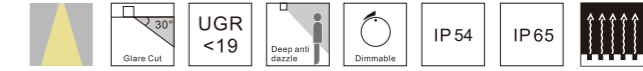

Model	Power	LED voltage	LED Current	CRI	CCT	Beam Angle	LED Output	System output	Dimming Type
KS-MD15R-A-415	15W	36V	350mA	90	2700K	30° 60°	1314lm 1314lm	1085lm 1187lm	ON-OFF TRIAC 1-10V DALI
	15W	36V	350mA	90	3000K	30° 60°	1283lm 1383lm	1142lm 1250lm	ON-OFF TRIAC 1-10V DALI
	15W	36V	350mA	90	4000K	30° 60°	1567lm 1567lm	1293lm 1416lm	ON-OFF TRIAC 1-10V DALI
KS-MD15R-A-420	20W	36V	500mA	90	2700K	30° 60°	2214lm 2214lm	1520lm 1640lm	ON-OFF TRIAC 1-10V DALI
	20W	36V	500mA	90	3000K	30° 60°	2326lm 2326lm	1591lm 1723lm	ON-OFF TRIAC 1-10V DALI
	20W	36V	500mA	90	4000K	30° 60°	2467lm 2467lm	1687lm 1827lm	ON-OFF TRIAC 1-10V DALI

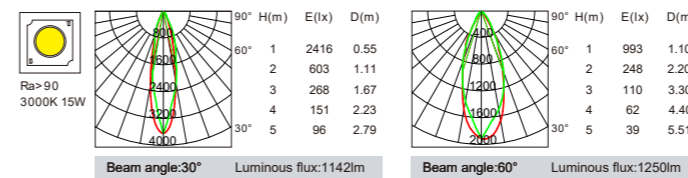

KS-MD15R-A-5

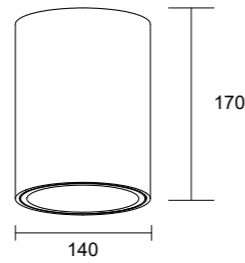

Model	Power	LED voltage	LED Current	CRI	CCT	Beam Angle	LED Output	System output	Dimming Type
KS-MD15R-A-525	25W	36V	600mA	90	2700K	30° 60°	2689lm 2689lm	1921lm 2142lm	ON-OFF TRIAC 1-10V DALI
	25W	36V	600mA	90	3000K	30° 60°	2791lm 2791lm	1994lm 2224lm	ON-OFF TRIAC 1-10V DALI
	25W	36V	600mA	90	4000K	30° 60°	2940lm 2940lm	2100lm 2342lm	ON-OFF TRIAC 1-10V DALI
KS-MD15R-A-530	30W	36V	700mA	90	2700K	30° 60°	2241lm 2241lm	2347lm 2518lm	ON-OFF TRIAC 1-10V DALI
	30W	36V	700mA	90	3000K	30° 60°	2326lm 2326lm	2437lm 2614lm	ON-OFF TRIAC 1-10V DALI
	30W	36V	700mA	90	4000K	30° 60°	2467lm 2467lm	2584lm 2772lm	ON-OFF TRIAC 1-10V DALI

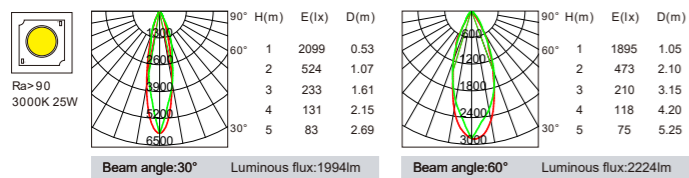

KS-MD15R-A-5

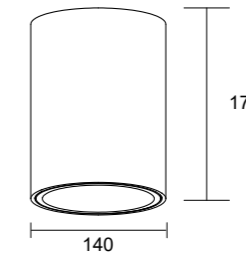

Model	Power	LED voltage	LED Current	CRI	CCT	Beam Angle	LED Output	System output	Dimming Type
KS-MD15R-A-535	35W	36V	1000mA	90	2700K	30° 60°	4317lm 4317lm	2444lm 2733lm	ON-OFF TRIAC 1-10V DALI
	35W	36V	1000mA	90	3000K	30° 60°	4592lm 4592lm	2600lm 2908lm	ON-OFF TRIAC 1-10V DALI
	35W	36V	1000mA	90	4000K	30° 60°	4864lm 4864lm	2754lm 3080lm	ON-OFF TRIAC 1-10V DALI

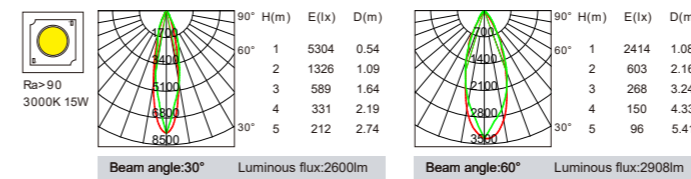



New MD16 Series



MD16 Series Mounted Downlight

Simple but exquisite, Kam's mounted downlight combines aesthetic features and performance. A variety of choices and customized services depending on your requirements.

New MD16 Series



KS-MD16-A-308
Power:8W
Diameter: 70mm
Height: 140mm

KS-MD16-A-308
Power:8W/10W
Diameter: 70mm
Height: 140mm

KS-MD16-A-415
Power:15W/20W
Diameter:100mm
Height: 170mm

KS-MD16-B-308
Power:8W/10W
Diameter: 70mm
Height: 140mm

KS-MD16-B-415
Power:15W/20W
Diameter: 100mm
Height: 170mm

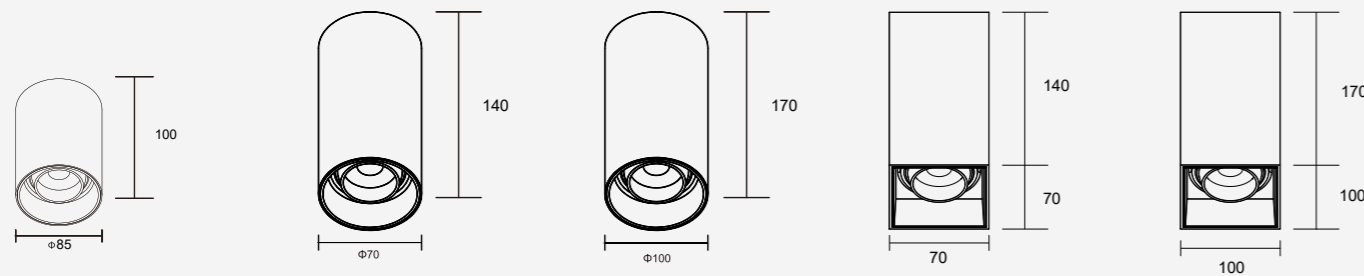

Model	KS-MD16-A-208	KS-MD16-A-308	KS-MD16-A-415	KS-MD16-B-308	KS-MD16-B-415
Product Photo					
Dimension(mm)					
Diameter	85	70	100	70*70	100*100
Wattage	8W	8W/10W	15W/20W	8W/10W	15W/20W
CCT	2700K 3000K 3500K 4000K	2700K 3000K 3500K 4000K	2700K 3000K 3500K 4000K	2700K 3000K 3500K 4000K	2700K 3000K 3500K 4000K
CRI	>90	>90	>90	>90	>90
Beam Angle	18°/24°/36°/50°	18°/24°/36°/50°	18°/24°/36°/50°	18°/24°/36°/50°	18°/24°/36°/50°
Lumen	737-967LM	737-967LM	1092-1735LM	737-967LM	1092-1735LM
IP	IP20	IP20	IP20	IP20	IP20
Dimming	TRIAC/1-10V/DALI	TRIAC/1-10V/DALI	TRIAC/1-10V/DALI	TRIAC/1-10V/DALI	TRIAC/1-10V/DALI
Colour	White+black	White+black	White+black	White+black	White+black

KS-MD16



KS-MD16-A-2

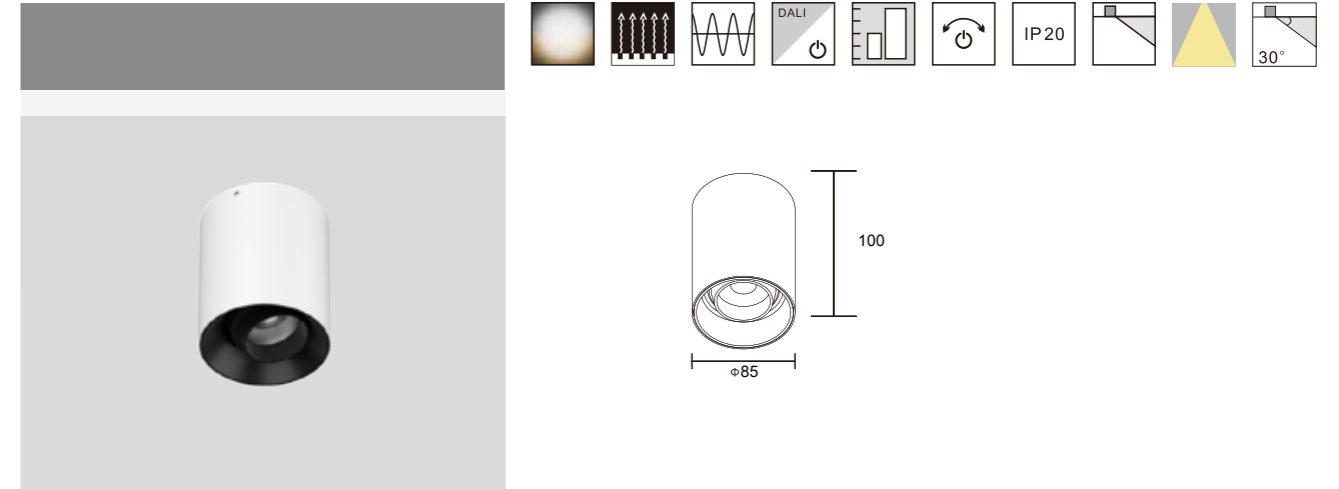

Model	Power	LED voltage	LED Current	CRI	CCT	Beam Angle	LED Output	System output	Dimming Type
KS-MD16-A-208	8W	36V	350mA	90	2700K	18°	1297lm	1092lm	ON-OFF
						24°	1297lm	1250lm	TRIAC
						36°	1297lm	1251lm	1-10V
						50°	1297lm	885lm	DALI
KS-MD16-A-300	8W	36V	350mA	90	3000K	18°	1348lm	1135lm	ON-OFF
						24°	1348lm	1300lm	TRIAC
						36°	1348lm	1301lm	1-10V
						50°	1348lm	922lm	DALI
KS-MD16-A-400	8W	36V	350mA	90	4000K	18°	1411lm	1188lm	ON-OFF
						24°	1411lm	1360lm	TRIAC
						36°	1411lm	1361lm	1-10V
						50°	1411lm	965lm	DALI

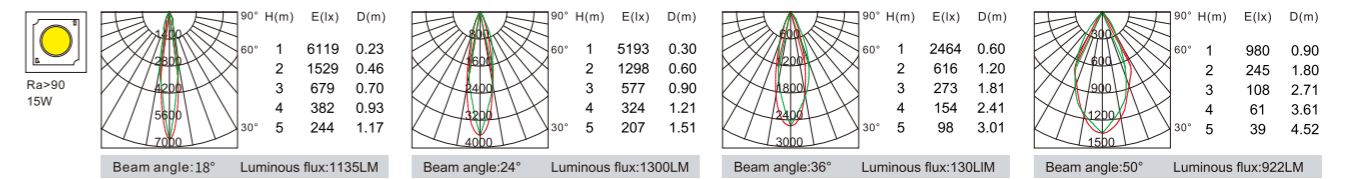

KS-MD16-A-3

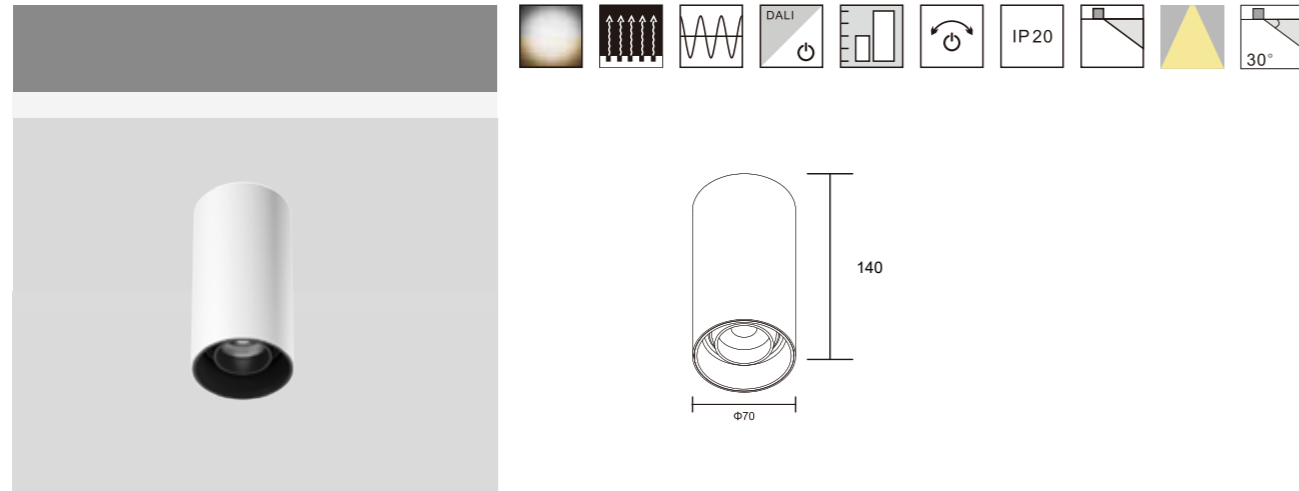

Model	Power	LED voltage	LED Current	CRI	CCT	Beam Angle	LED Output	System output	Dimming Type
KS-MD16-A-308	8W	36V	200mA	90	2700K	18°	741lm	737lm	ON-OFF
						24°	741lm	649lm	TRIAC
						36°	741lm	537lm	1-10V
						50°	741lm	508lm	DALI
	8W	36V	200mA	90	3000K	18°	770lm	766lm	ON-OFF
						24°	770lm	675lm	TRIAC
						36°	770lm	559lm	1-10V
						50°	770lm	528lm	DALI
	8W	36V	200mA	90	4000K	18°	806lm	801lm	ON-OFF
						24°	806lm	706lm	TRIAC
						36°	806lm	585lm	1-10V
						50°	806lm	552lm	DALI
KS-MD16-A-310	10W	36V	250mA	90	2700K	18°	927lm	905lm	ON-OFF
						24°	927lm	854lm	TRIAC
						36°	927lm	757lm	1-10V
						50°	927lm	658lm	DALI
	10W	36V	250mA	90	3000K	18°	963lm	941lm	ON-OFF
						24°	963lm	888lm	TRIAC
						36°	963lm	729lm	1-10V
						50°	963lm	684lm	DALI
	10W	36V	250mA	90	4000K	18°	1008lm	967lm	ON-OFF
						24°	1008lm	929lm	TRIAC
						36°	1008lm	763lm	1-10V
						50°	1008lm	715lm	DALI

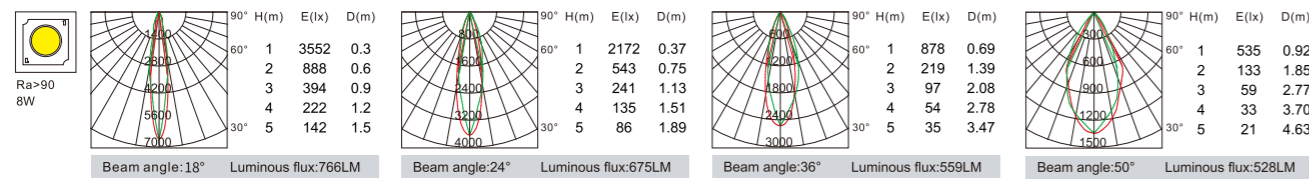

KS-MD16-A-4

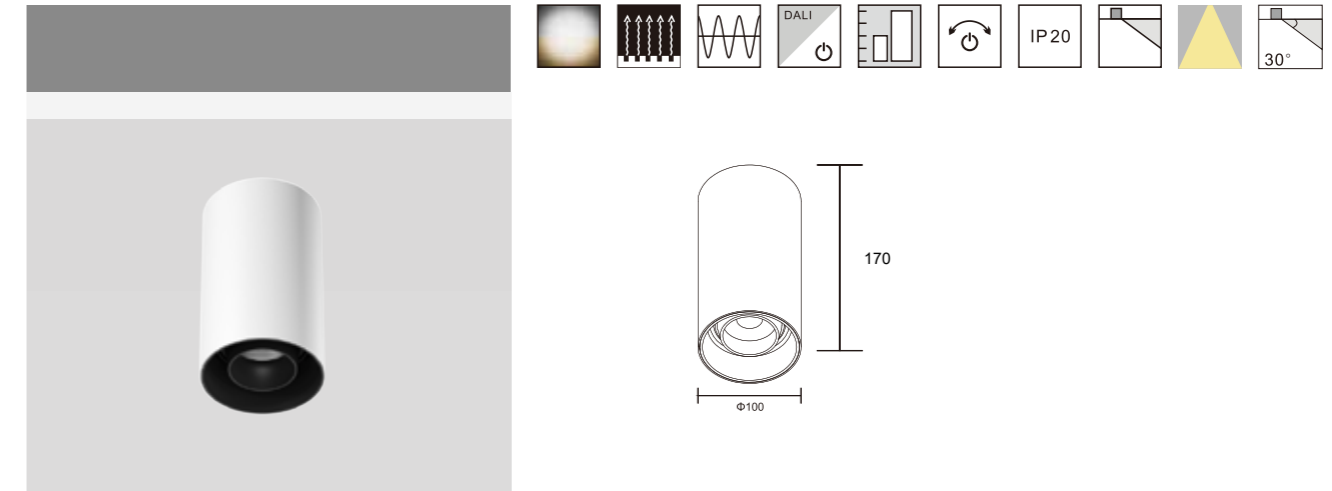

Model	Power	LED voltage	LED Current	CRI	CCT	Beam Angle	LED Output	System output	Dimming Type
KS-MD16-A-415	15W	36V	350mA	90	2700K	18°	1297lm	1092lm	ON-OFF
						24°	1297lm	1250lm	TRIAC
						36°	1297lm	1251lm	1-10V
						50°	1297lm	885lm	DALI
	15W	36V	350mA	90	3000K	18°	1348lm	1135lm	ON-OFF
						24°	1348lm	1300lm	TRIAC
						36°	1348lm	1301lm	1-10V
						50°	1348lm	922lm	DALI
	15W	36V	350mA	90	4000K	18°	1411lm	1188lm	ON-OFF
						24°	1411lm	1360lm	TRIAC
						36°	1411lm	1361lm	1-10V
						50°	1411lm	965lm	DALI
KS-MD16-A-420	20W	36V	500mA	90	2700K	18°	1854lm	1416lm	ON-OFF
						24°	1854lm	1694lm	TRIAC
						36°	1854lm	1596lm	1-10V
						50°	1854lm	1184lm	DALI
	20W	36V	500mA	90	3000K	18°	1926lm	1472lm	ON-OFF
						24°	1926lm	1760lm	TRIAC
						36°	1926lm	1658lm	1-10V
						50°	1926lm	1231lm	DALI
	20W	36V	500mA	90	4000K	18°	2016lm	1540lm	ON-OFF
						24°	2016lm	1842lm	TRIAC
						36°	2016lm	1735lm	1-10V
						50°	2016lm	1288lm	DALI

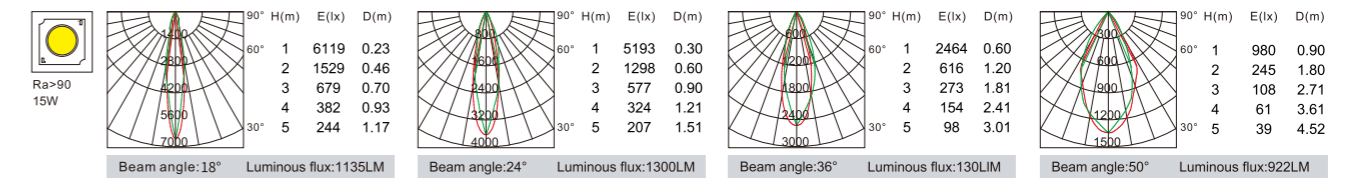

KS-MD16-B-3

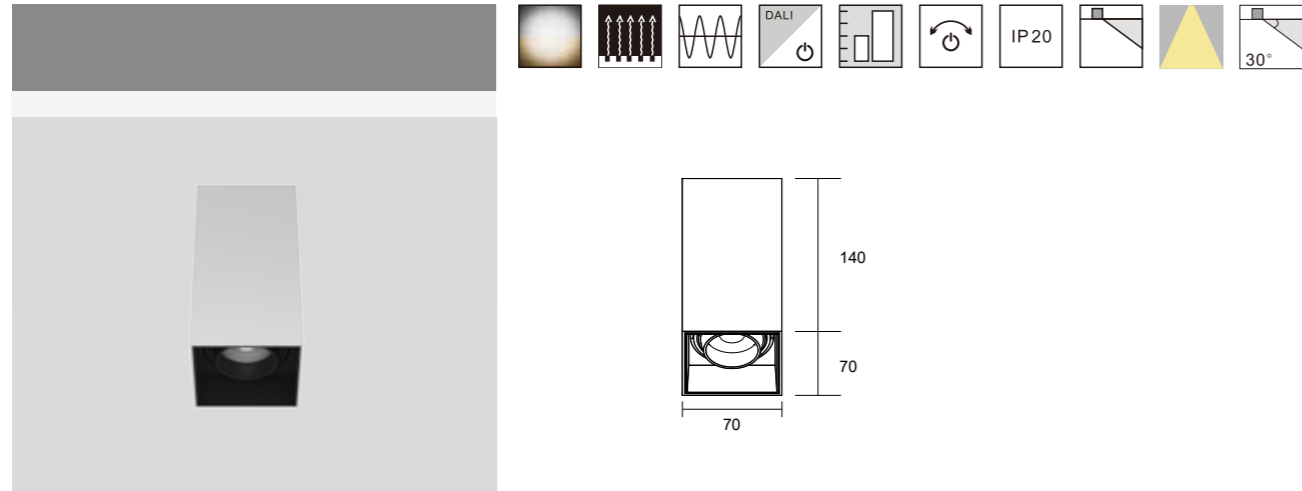

Model	Power	LED voltage	LED Current	CRI	CCT	Beam Angle	LED Output	System output	Dimming Type
KS-MD16-B-308	8W	36V	200mA	90	2700K	18°	741lm	737lm	ON-OFF
						24°	741lm	649lm	TRIAC
						36°	741lm	537lm	1-10V
						50°	741lm	508lm	DALI
	8W	36V	200mA	90	3000K	18°	770lm	766lm	ON-OFF
						24°	770lm	675lm	TRIAC
						36°	770lm	559lm	1-10V
						50°	770lm	528lm	DALI
	8W	36V	200mA	90	4000K	18°	806lm	801lm	ON-OFF
						24°	806lm	706lm	TRIAC
						36°	806lm	585lm	1-10V
						50°	806lm	552lm	DALI
KS-MD16-B-310	10W	36V	250mA	90	2700K	18°	927lm	905lm	ON-OFF
						24°	927lm	854lm	TRIAC
						36°	927lm	701lm	1-10V
						50°	927lm	656lm	DALI
	10W	36V	250mA	90	3000K	18°	963lm	941lm	ON-OFF
						24°	963lm	888lm	TRIAC
						36°	963lm	729lm	1-10V
						50°	963lm	684lm	DALI
	10W	36V	250mA	90	4000K	18°	1008lm	984lm	ON-OFF
						24°	1008lm	929lm	TRIAC
						36°	1008lm	763lm	1-10V
						50°	1008lm	715lm	DALI

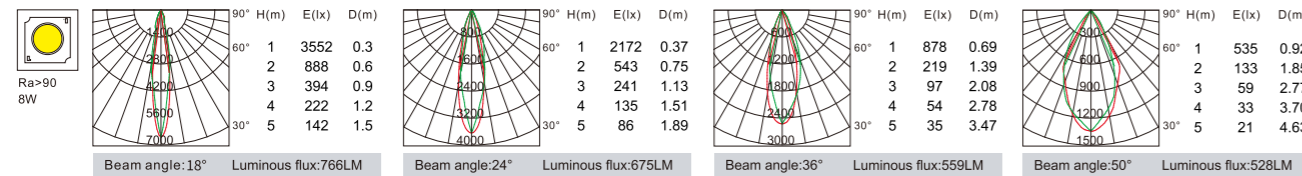

KS-MD16-B-4

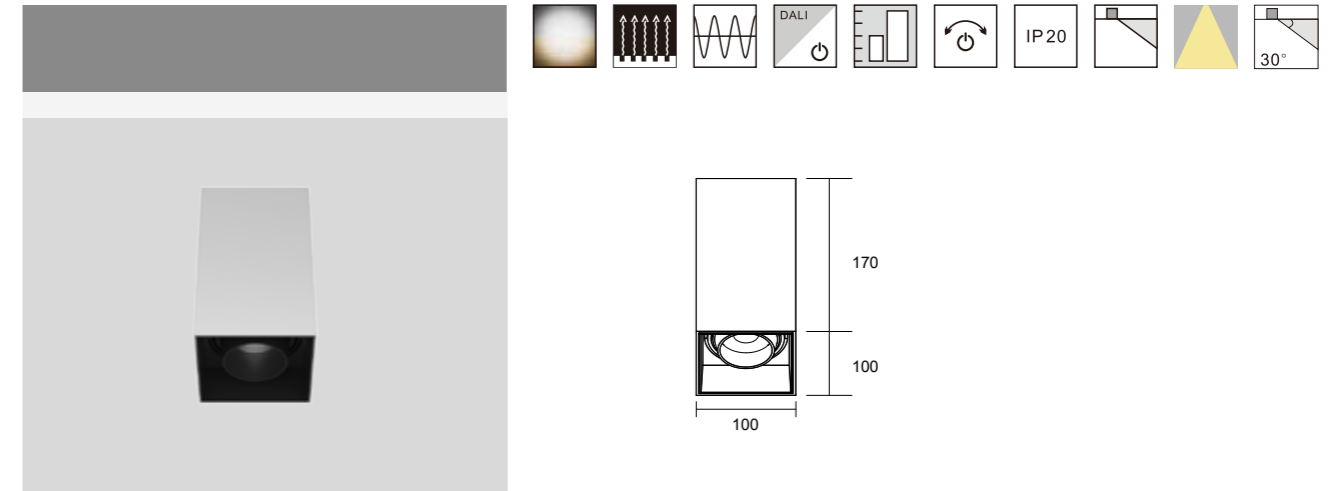

Model	Power	LED voltage	LED Current	CRI	CCT	Beam Angle	LED Output	System output	Dimming Type
KS-MD16-B-415	15W	36V	350mA	90	2700K	18°	1297lm	1092lm	ON-OFF
						24°	1297lm	1250lm	TRIAC
						36°	1297lm	1251lm	1-10V
						50°	1297lm	885lm	DALI
	15W	36V	350mA	90	3000K	18°	1348lm	1135lm	ON-OFF
						24°	1348lm	1300lm	TRIAC
						36°	1348lm	1301lm	1-10V
						50°	1348lm	922lm	DALI
	15W	36V	350mA	90	4000K	18°	1411lm	1188lm	ON-OFF
						24°	1411lm	1360lm	TRIAC
						36°	1411lm	1361lm	1-10V
						50°	1411lm	965lm	DALI
KS-MD16-B-420	20W	36V	500mA	90	2700K	18°	1854lm	1416lm	ON-OFF
						24°	1854lm	1694lm	TRIAC
						36°	1854lm	1596lm	1-10V
						50°	1854lm	1184lm	DALI
	20W	36V	500mA	90	3000K	18°	1926lm	1472lm	ON-OFF
						24°	1926lm	1760lm	TRIAC
						36°	1926lm	1658lm	1-10V
						50°	1926lm	1231lm	DALI
	20W	36V	500mA	90	4000K	18°	2016lm	1540lm	ON-OFF
						24°	2016lm	1842lm	TRIAC
						36°	2016lm	1735lm	1-10V
						50°	2016lm	1288lm	DALI

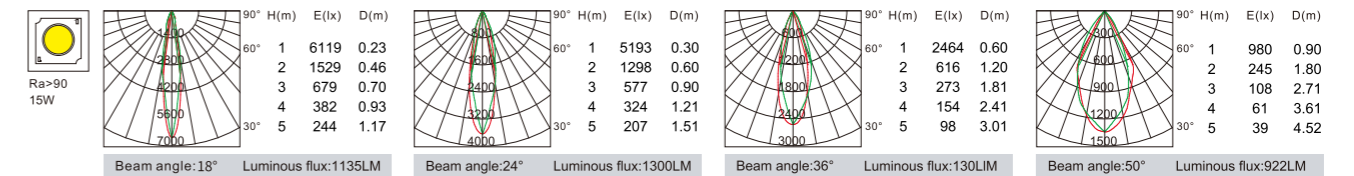

KAS-UT25 Series

Model	K-UT25-Q80	K-UT25-B80	K-UT25-MD90		K-UT25-YSBD	K-UT25-TD68	K-UT25-DT68F
Product Photo							
Dimension(mm)							
Wattage	12W	6W	6W		6W	6W	6W
CCT	2700K/3000K/3500K/4000K/6000K	2700K/3000K/3500K/4000K/6000K	2700K/3000K/3500K/4000K/6000K		2700K/3000K/3500K/4000K/6000K	2700K/3000K/3500K/4000K/6000K	2700K/3000K/3500K/4000K/6000K
CRI	>90	>90	>90		>90	>90	>90
Beam Angle	24°	120°	24°		120°	24°	110°
Lumen	619-727lm	685-803lm	619-727lm		685-803lm	366-427lm	366-427lm
IP	IP20	IP20	IP20		IP20	IP20	IP20
Colour	Black/White	Black/White	Black/White		Black/White	Black/White	Black/White
Dimming	TRIAC/1-10V/DALI/2.4G/Bluetooth	TRIAC/1-10V/DALI/2.4G/Bluetooth	TRIAC/1-10V/DALI/2.4G/Bluetooth		TRIAC/1-10V/DALI/2.4G/Bluetooth	TRIAC/1-10V/DALI/2.4G/Bluetooth	TRIAC/1-10V/DALI/2.4G/Bluetooth

K-UT25-Q80

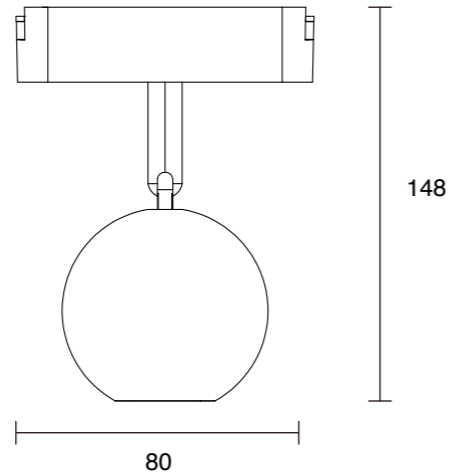

K-UT25-B80

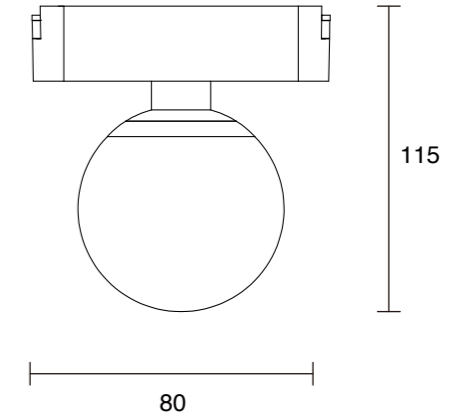
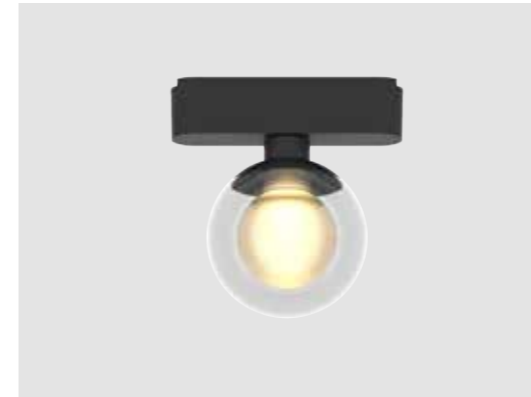

Model	Power	LED voltage	LED Current	CRI	CCT	Beam Angle	LED Output	System output	Dimming Type
K-UT25-Q80	12W	36V	300mA	90	3000K	24°	963lm	493lm	TRIAC 1-10V DALI 2.4G Bluetooth
	12W	36V	300mA	90	4000K	24°	1019lm	521lm	TRIAC 1-10V DALI 2.4G Bluetooth
	12W	36V	300mA	90	5700K	24°	1131lm	579lm	TRIAC 1-10V DALI 2.4G Bluetooth

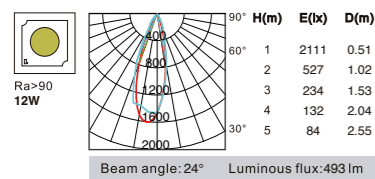

Model	Power	LED voltage	LED Current	CRI	CCT	Beam Angle	LED Output	System output	Dimming Type
K-UT25-B80	6W	36V	150mA	90	3000K	120°	1284lm	268lm	TRIAC 1-10V DALI 2.4G Bluetooth
	6W	36V	150mA	90	4000K	120°	1358lm	283lm	TRIAC 1-10V DALI 2.4G Bluetooth
	6W	36V	150mA	90	5700K	120°	1506lm	314lm	TRIAC 1-10V DALI 2.4G Bluetooth

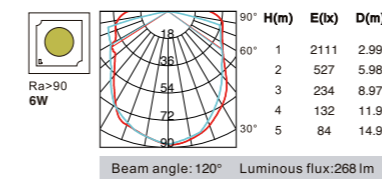

K-UT25-MD90

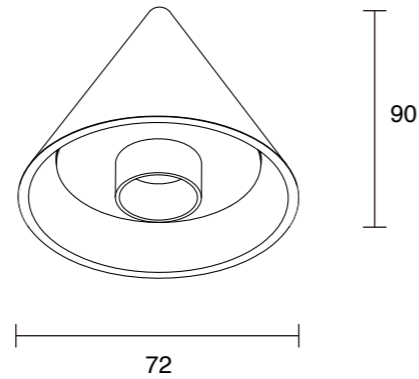

Model	Power	LED voltage	LED Current	CRI	CCT	Beam Angle	LED Output	System output	Dimming Type
K-UT25-MD90	6W	36V	300mA	90	3000K	24°	642lm	233lm	TRIAC 1-10V DALI 2.4G Bluetooth
	6W	36V	300mA	90	4000K	24°	679lm	246lm	TRIAC 1-10V DALI 2.4G Bluetooth
	6W	36V	300mA	90	5700K	24°	753lm	273lm	TRIAC 1-10V DALI 2.4G Bluetooth

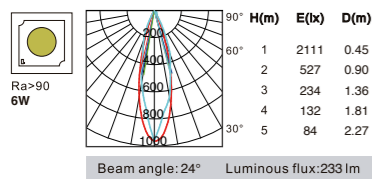

K-UT25-YSBD

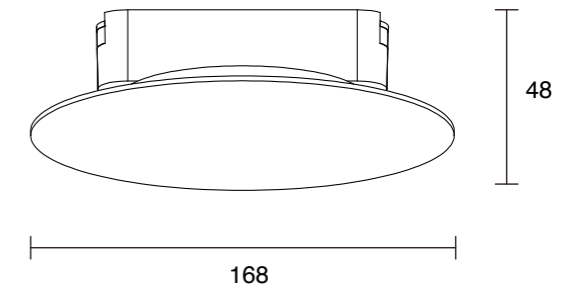
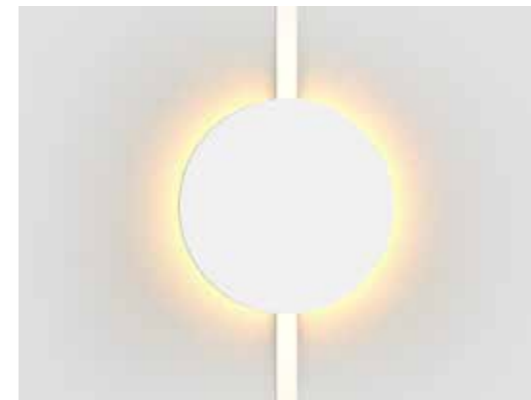
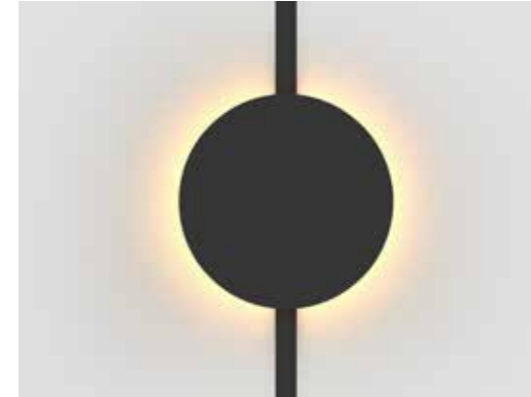

Model	Power	LED voltage	LED Current	CRI	CCT	Beam Angle	LED Output	System output	Dimming Type
K-UT25-YSBD	6W	36V	150mA	90	3000K	120°	642lm	366lm	TRIAC 1-10V DALI 2.4G Bluetooth
	6W	36V	150mA	90	4000K	120°	387lm	387lm	TRIAC 1-10V DALI 2.4G Bluetooth
	6W	36V	150mA	90	5700K	120°	429lm	429lm	TRIAC 1-10V DALI 2.4G Bluetooth

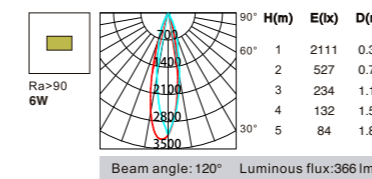

K-UT25-TD68

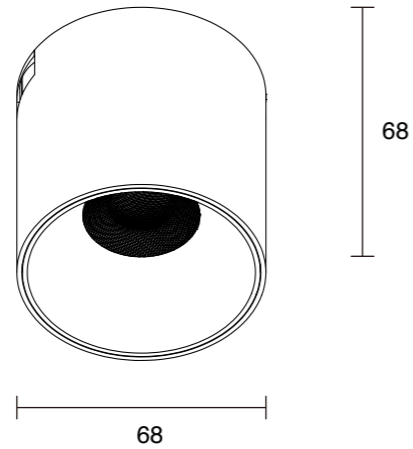
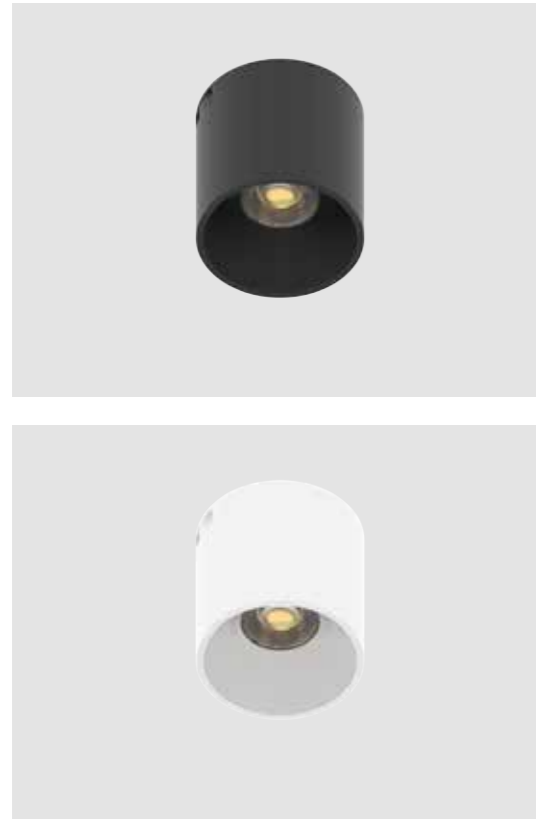

Model	Power	LED voltage	LED Current	CRI	CCT	Beam Angle	LED Output	System output	Dimming Type
K-UT25-TD68	6W	36V	300mA	90	3000K	24°	642lm	317m	TRIAC 1-10V DALI 2.4G Bluetooth
	6W	36V	300mA	90	4000K	24°	679lm	335lm	TRIAC 1-10V DALI 2.4G Bluetooth
	6W	36V	300mA	90	5700K	24°	753lm	371lm	TRIAC 1-10V DALI 2.4G Bluetooth

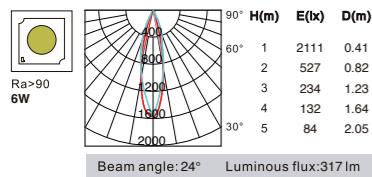

K-UT25-TD68F

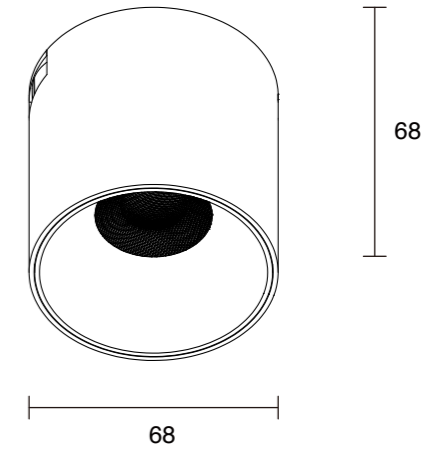

Model	Power	LED voltage	LED Current	CRI	CCT	Beam Angle	LED Output	System output	Dimming Type
K-UT25-TD68F	6W	36V	150mA	90	3000K	110°	642lm	317lm	TRIAC 1-10V DALI 2.4G Bluetooth
	6W	36V	150mA	90	4000K	110°	679lm	335lm	TRIAC 1-10V DALI 2.4G Bluetooth
	6W	36V	150mA	90	5700K	110°	753lm	371lm	TRIAC 1-10V DALI 2.4G Bluetooth

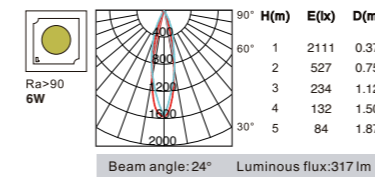

Contact details

IINNO Ltd

2101A Nan Fung Centre,
264-298 Castle Peak Road,
Tsuen Wan, Hong Kong

Tel: +852 2134 9906

+86 (0)769 23010151/2

M: +86 13922905402

Email: sales@iinno-lighting.com

www.iinno-lighting.com



