



# Industrial Lighting

Designing your lighting solutions



# Contents

## Low Glare Battens



Weston Batten  
019-020



Upton Batten  
021-022



Kingston Batten  
023-024



Hilton Batten  
025-026



Kaston Batten  
027-028



Sutton Batten  
029-030

## Linear Light



Marco linear  
033-038



Polo suspend linear  
039-042

## Batten Light



T8 Slim Batten  
045-046



Narrow Slim Batten  
047



Frosted Slim Batten  
048



Upton Frosted | 80mm  
049



Kingston Frosted | 120mm  
050



Hilton Frosted | 150mm  
051



Kaston Frosted | 200mm  
052



Wega Batten  
053



General Batten  
054



TX Batten  
055



Grid Batten  
056



Arco Batten  
057-058



Recessed Batten  
059



Recessed Frosted  
060

## Retro Flex Fitting



Retro Flex | Honeycomb  
063-066



Retro Flex | PC  
063-066



Retro Flex | Lens  
063-066

# Contents

## Pro-Line



Gentle Module  
067-072



Frosted Module  
067-072



Lens Module  
067-072



Narrow Module  
067-072



T8 Module  
067-072

## Asymmetric Light



Fasco Asymmetric Light  
075



Dasco Asymmetric Light  
076



Track Asymmetric Light  
077-078

## Tri-Proof Light



Prime Tri-proof | TR100  
081-082



Deco Tri-proof | TR200  
083-084



Deco S Tri-proof | TR200  
085-086



Basic Tri-proof | TR300  
087



Tubar Light | TR400  
088



Single NCF | TR500  
089-090



Twins NCF | TR510  
091-092

## LED Bulkheads



MOD  
095-100



Gamma  
101-104



Pro R  
105-107



Pro RA  
108



Pro S  
109



Pro SA  
110



Lunar  
111-114



Astro  
115-118

# Contents

## LED Bulkheads



Delta  
119-120

## Wall Pack



Wall Pack  
121-122



Wall Pack  
123-124

## Ceiling Light



Vasco R350A  
127-128



Vasco R450A  
129



Vasco R600A  
130



Vasco R900A  
131-132



LEO R355A  
133-134



LEO R435A  
135-136

## Panel Light



Backlit Panel  
139-145



Edgelit Panel  
147-152



Air Handling Panel  
153-154



Upscale Panel  
155-156

## LED Down Light



EVO Down Light  
DL100  
159



Slim Down Light  
DL200  
160



Halo Down Light  
DL300  
161



Halo Down Light  
DL400  
162

## LED Tube



T8 LED Tube  
165



T6 LED Tube  
166



Cabinet Light  
167-168

# Product Guide

Product category/name

Product picture

Certificate symbols

Dimension drawing

Product profile

Key features/  
selling points

Options

Options for CCT/function/  
electrical/photometric/  
wiring/IP rating/finish, etc

Order code

These unique codes relate  
to individual product  
specification

Package information for container

**Weston Batten**  
Low glare | 55mm

SAA CE UK CA

Weston is 55mm low glare linear which were widely used in the office / commercial / industrial / education applications. Aluminum case is a excellent heating sink, the high technology SMD2835 provide a more higher lumen output.

**Features**

- > Low glare UGR<22
- > End or rear cable entry
- > Single or multiple link
- > 5 years warranty

**Data Sheet**

Order Code	Rated Power	Lumen	LMW	Flicker Free	Dimension (mm)	GW/CTN	QTY/CTN
BT02-10KN1-SWNE-001	10W	5tp.1200	typ.120	Y	L605 X W55 X H63.5	6.0kg	8pcs
BT04-17KN1-SWNE-001	17W	5tp.2040	typ.120	Y	L1205 X W55 X H63.5	11.5kg	8pcs
BT04-30KN1-SWNE-001	34W	5tp.4280	typ.120	Y	L1205 X W55 X H63.5	11.5kg	8pcs
BT05-22KN1-SWNE-001	22W	5tp.2040	typ.120	Y	L1805 X W55 X H63.5	14.5kg	8pcs
BT05-40KN1-SWNE-001	40W	5tp.4280	typ.120	Y	L1805 X W55 X H63.5	14.5kg	8pcs
BT05-27KN1-SWNE-001	27W	5tp.3240	typ.120	Y	L1805 X W55 X H63.5	17.0kg	8pcs
BT05-50KN1-SWNE-001	50W	5tp.6000	typ.120	Y	L1805 X W55 X H63.5	17.0kg	8pcs

# Contents

## UFO Highbay



REVO UFO | HB100  
■ 171-172



Elite UFO | HB200  
■ 173-174



Mate UFO | HB400  
■ 175-176



Mate UFO | HB420  
■ 177



Mate UFO | HB430  
■ 178

## Linear Highbay



T-line  
HB500  
■ 182



T-line  
HB520  
■ 183



T-line  
HB540  
■ 184



Modular Highbay  
HB600 | 3x100W- (60cm)  
■ 187

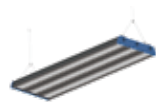

Modular Highbay  
HB602 | 3x150W- (90cm)  
■ 188

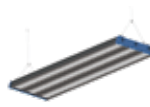

Modular Highbay  
HB604 | 3x200W- (120cm)  
■ 189

# Product Guide

Product category/name

Product picture

Certificate symbols

Dimension drawing

Product profile

Key features/selling points

Options

Options for CCT/function/electrical/photometric/wiring/IP rating/finish, etc

Order code

These unique codes relate to individual product specification

Package information for container

Order Code	Rated Power	Lumen	LMW	Flicker Free	Dimension (mm)	GW/CTN	QTY/CTN
HB02-1ATN1-TSNGS-001	100W	15000	150	Y	L623 X W138 X H73	5.9kg	1pcs
HB03-1CTN1-TSNGS-001	120W	18000	150	Y	L923 X W138 X H73	7.9kg	1pcs
HB03-1BTN1-TSNGS-001	150W	22000	150	Y	L923 X W138 X H73	7.9kg	1pcs
HB04-2ATN1-TSNGS-001	200W	30000	150	Y	L1223 X W138 X H73	10.0kg	1pcs



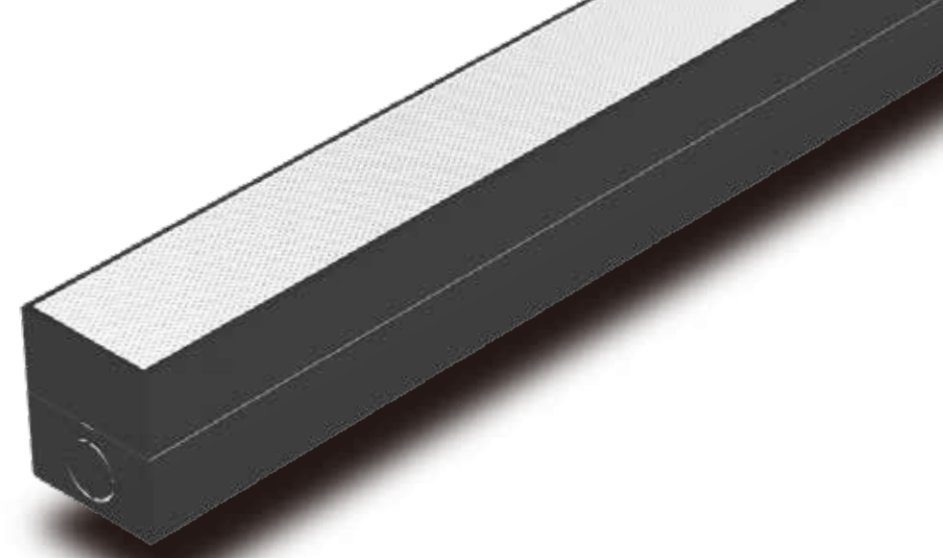

## Weston Batten

BT100 | 55mm

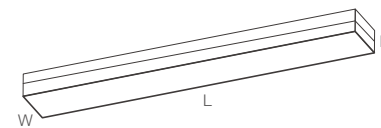

Weston is 55mm low glare linear which were widely used in the office /commercial / industrial / education applications. Aluminum case is a excellent heating sink, the high technology SMD2835 provide a more higher lumen output.

### ► Features

- > Low glare UGR<22
- > End or rear cable entry
- > Single or multiple link
- > 5 years warranty

### ► CCT

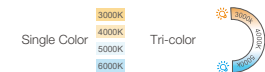

### ► Function



### ► Electrical Parameters



### ► Photometric Parameters



### ► Data Sheet

Order Code	Rated Power	Lumen	LM/W	Flicker Free	Dimension (mm)	GW/CTN	QTY/CTN
BT100-02W-KN1-10F01-00	10W	typ.1200	typ.120	Y	L605 X W55 X H63.5	6.0kg	8pcs
BT100-04W-KN1-17F01-00	17W	typ.2040	typ.120	Y	L1205 X W55 X H63.5	11.5kg	8pcs
BT100-04W-KN1-34F01-00	34W	typ.4080	typ.120	Y	L1205 X W55 X H63.5	11.5kg	8pcs
BT100-05W-KN1-28F01-00	28W	typ.2640	typ.120	Y	L1505 X W55 X H63.5	14.5kg	8pcs
BT100-05W-KN1-40F01-00	40W	typ.4800	typ.120	Y	L1505 X W55 X H63.5	14.5kg	8pcs
BT100-06W-KN1-31F01-00	31W	typ.3720	typ.120	Y	L1805 X W55 X H63.5	17.0kg	8pcs
BT100-06W-KN1-62F01-00	62W	typ.7440	typ.120	Y	L1805 X W55 X H63.5	17.0kg	8pcs



Finish \_\_\_\_\_



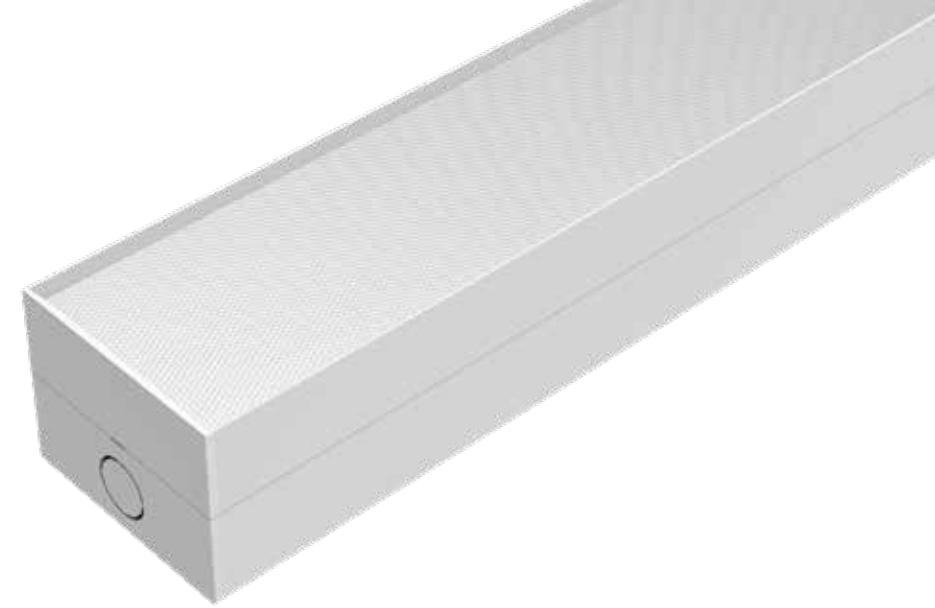

## Upton Batten

BT110 | 80mm

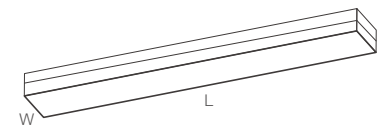

Upton Batten is 80mm low glare linear which were widely used on the office / commercial / industrial / education applications. Aluminum case is a excellent heating sink, the high technology SMD2835 provide a more higher lumen output.

### Features

- > Low glare UGR<19
- > End or rear cable entry
- > Single or multiple link
- > 5 years warranty

### ▶ CCT

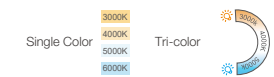

### ▶ Function



### ▶ Electrical Parameters



### ▶ Photometric Parameters



### Data Sheet

Order Code	Rated Power	Lumen	LM/W	Flicker Free	Dimension (mm)	GW/CTN	QTY/CTN
BT110-02W-KN1-10F01-00	10W	typ.1200	typ.120	Y	L600 X W80 X H63.5	7.0kg	6pcs
BT110-04W-KN1-17F01-00	17W	typ.2040	typ.120	Y	L1200 X W80 X H63.5	12.0kg	6pcs
BT110-04W-KN1-34F01-00	34W	typ.4080	typ.120	Y	L1200 X W80 X H63.5	12.0kg	6pcs
BT110-05W-KN1-22F01-00	22W	typ.2640	typ.120	Y	L1500 X W80 X H63.5	14.0kg	6pcs
BT110-05W-KN1-40F01-00	40W	typ.4800	typ.120	Y	L1500 X W80 X H63.5	14.0kg	6pcs
BT110-06W-KN1-27F01-00	27W	typ.3240	typ.120	Y	L1800 X W80 X H63.5	18.0kg	6pcs
BT110-06W-KN1-50F01-00	50W	typ.6000	typ.120	Y	L1800 X W80 X H63.5	18.0kg	6pcs

# Upton Batten



Finish \_\_\_\_\_





# Kingston Batten

## BT120 | 120mm

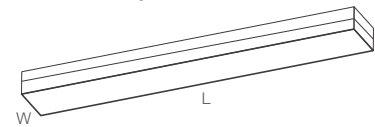

Kingston batten is a 120mm low glare batten with UGR<19. It was widely used on the office / commercial / industrial / education applications. Aluminum case is an excellent heat sink, the high technology SMD2835 provide a more higher lumen output.

### Features

- > Low glare UGR<19
- > End or rear cable entry
- > Single or multiple link
- > 5 years warranty

### Data Sheet

Order Code	Rated Power	Lumen	LM/W	Flicker Free	Dimension (mm)	GW/CTN	QTY/CTN
BT120-02W-KN1-10F01-00	10W	typ.1200	typ.120	Y	L600 X W120 X H63.5	7.0kg	4pcs
BT120-04W-KN1-17F01-00	17W	typ.2040	typ.120	Y	L1200 X W120 X H63.5	10.5kg	4pcs
BT120-04W-KN1-34F01-00	34W	typ.4080	typ.120	Y	L1200 X W120 X H63.5	10.5kg	4pcs
BT120-04W-KN1-22F01-00	22W	typ.2640	typ.120	Y	L1500 X W120 X H63.5	13.0kg	4pcs
BT120-05W-KN1-40F01-00	40W	typ.4800	typ.120	Y	L1500 X W120 X H63.5	13.0kg	4pcs
BT120-06W-KN1-27F01-00	27W	typ.3240	typ.120	Y	L1800 X W120 X H63.5	15.5kg	4pcs
BT120-06W-KN1-50F01-00	50W	typ.6000	typ.120	Y	L1800 X W120 X H63.5	15.5kg	4pcs

### CCT



### Function



### Electrical Parameters



### Photometric Parameters



### Finish





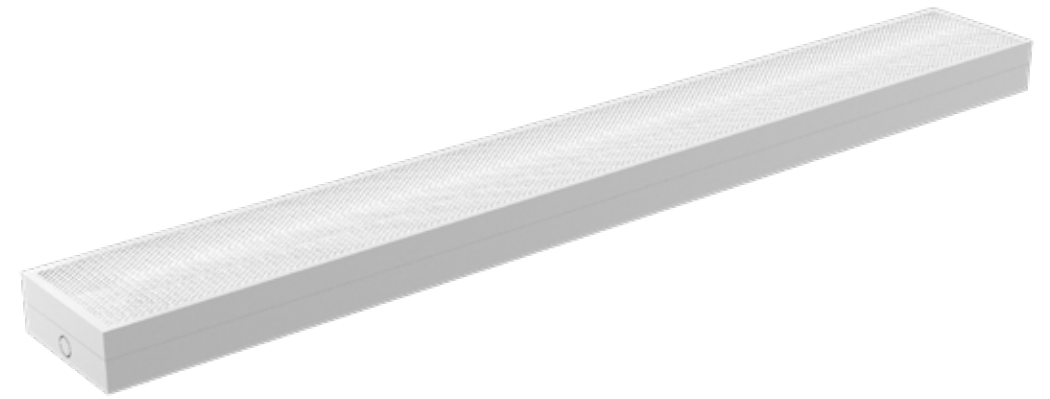

# Hilton Batten

## BT130 | 150mm

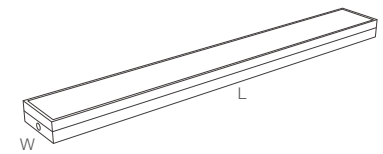

HiltonBatten is a 150mm low glare linear which were widely used on the office /commercial / industrial / education applications. Aluminum case is a excellent heating sink, the high technology SMD2835 provide a more higher lumen output.

### Features

- > Low glare UGR<19
- > End or rear cable entry
- > Single or multiple link
- > 5 years warranty

**CCT**

Single Color  3000K  4000K  5000K  6000K

Tri-color

**Function**

ON OFF  1-10V Dimming **DALI**  MS  PIR  Emergency

**Electrical Parameters**

AC 200-240V  PF  $\geq 0.95$  THD <15% Flicker Free

**Photometric Parameters**

120 LM/W  140 LM/W  CRI>80 SDCM <5  UGR <19  LM79 TM-21

### Data Sheet

Order Code	Rated Power	Lumen	LM/W	Flicker Free	Dimension (mm)	GW/CTN	QTY/CTN
BT130-04W-KN1-25F01-00	25W	typ.3100	typ.125	Y	L1200 X W150 X H64	18.5kg	3pcs
BT130-04W-KN1-40F01-00	40W	typ.5000	typ.125	Y	L1200 X W150 X H64	18.5kg	3pcs
BT130-05W-KN1-45F01-00	45W	typ.5600	typ.125	Y	L1500 X W150 X H64	22.0kg	3pcs
BT130-05W-KN1-60F01-00	60W	typ.7500	typ.125	Y	L1500 X W150 X H64	22.0kg	3pcs

# Hilton Batten



### Finish





# Kaston Batten

BT140 | 200mm

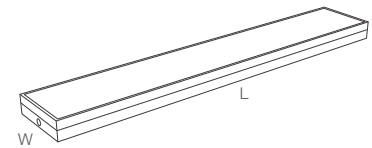

Kaston batten is a 200mm low glare linear which were widely used on the office /commercial / industrial / education applications. Aluminum case is an excellent heating sink, the high technology SMD2835 provide a more higher lumen output.

### Features

- > Low glare UGR<19
- > End or rear cable entry
- > Single or multiple link
- > 5 years warranty

### Data Sheet

Order Code	Rated Power	Lumen	LM/W	Flicker Free	Dimension (mm)	GW/CTN	QTY/CTN
BT140-04W-KN1-25F01-00	25W	typ.3100	typ.125	Y	L1200 X W200 X H64	18.5kg	3pcs
BT140-04W-KN1-40F01-00	40W	typ.5000	typ.125	Y	L1200 X W200 X H64	18.5kg	3pcs
BT140-05W-KN1-45F01-00	45W	typ.5600	typ.125	Y	L1500 X W200 X H64	22.0kg	3pcs
BT140-05W-KN1-60F01-00	60W	typ.7500	typ.125	Y	L1500 X W200 X H64	22.0kg	3pcs

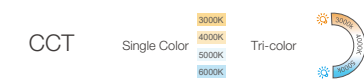

### Electrical Parameters



### Photometric Parameters



Finish \_\_\_\_\_







# Sutton Batten



## Sutton Batten BT160 | 200mm

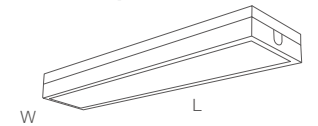

Sutton batten is a 200mm steel low glare linear with various of functions, The insert inner unit makes the sutton batten easy on the installation and replacement . Sutton batten were widely used on the commercial / industrial / office and campus applications

### ► Features

- > Low glare UGR<19
- > End or rear cable entry
- > Single or multiple link
- > 5 years warranty

### ► Data Sheet

Order Code	Rated Power	Lumen	LM/W	Flicker Free	Dimension (mm)	GW/CTN	QTY/CTN
BT160-04W-PN1-40F01-00	40W	typ.5600	typ.140	Y	L1170X W170 X H30	22.0kg	4pcs
BT160-05W-PN1-60F01-00	60W	typ.8400	typ.140	Y	L1470 X W170 X H30	25.0kg	4pcs

### ► CCT

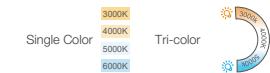

### ► Function



### ► Electrical Parameters



### ► Photometric Parameters



Finish \_\_\_\_\_



# Marco Linear

Finish

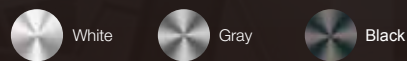

## Marco Linear

LL500

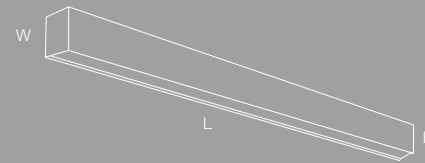

Marco linear is a linkable designed LED lighting. It has the different lighting options, installation options and different connecting options . and the maximum link length has no limited.

The above various of functions make the marco linear very modern and popular on the office lighting, commercial lighting , retail lighting etc.

### ► Features

- > Own patent design
- > Multiple link without limited
- > Various of lighting / Installation / connection options
- > CCT and wattage adjustable
- > DALI / Bluetooth / WIFI control
- > 5 years warranty

### ► Data Sheet

Order Code	Rated Power	Lumen	LM/W	Flicker Free	Dimension (mm)	GW/CTN	QTY/CTN
LL500-04W-KNT1-36F01-00	36W	typ.4350	typ.125	Y	L1200 X W55 X H80	12.5kg	5pcs
LL501-04W-KNT1-36F01-00	36W	typ.4350	typ.125	Y	L1200 X W55 X H80	12.5kg	5pcs

### ► CCT



### ► Function



### ► Electrical Parameters



### ► Photometric Parameters



## Lighting Options



## Installation Method



## Case Options

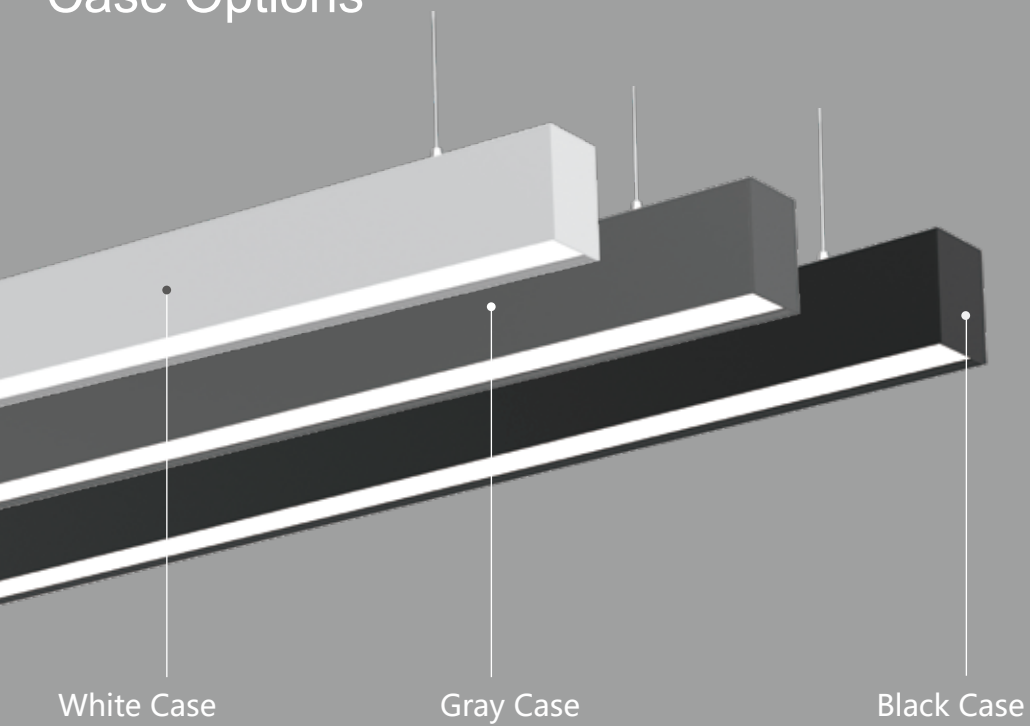

## Illuminated connectors

in the shapes X, L and T for the design of formations according to individual wishes



Straight Connector



L Connector



T Connector



X Connector

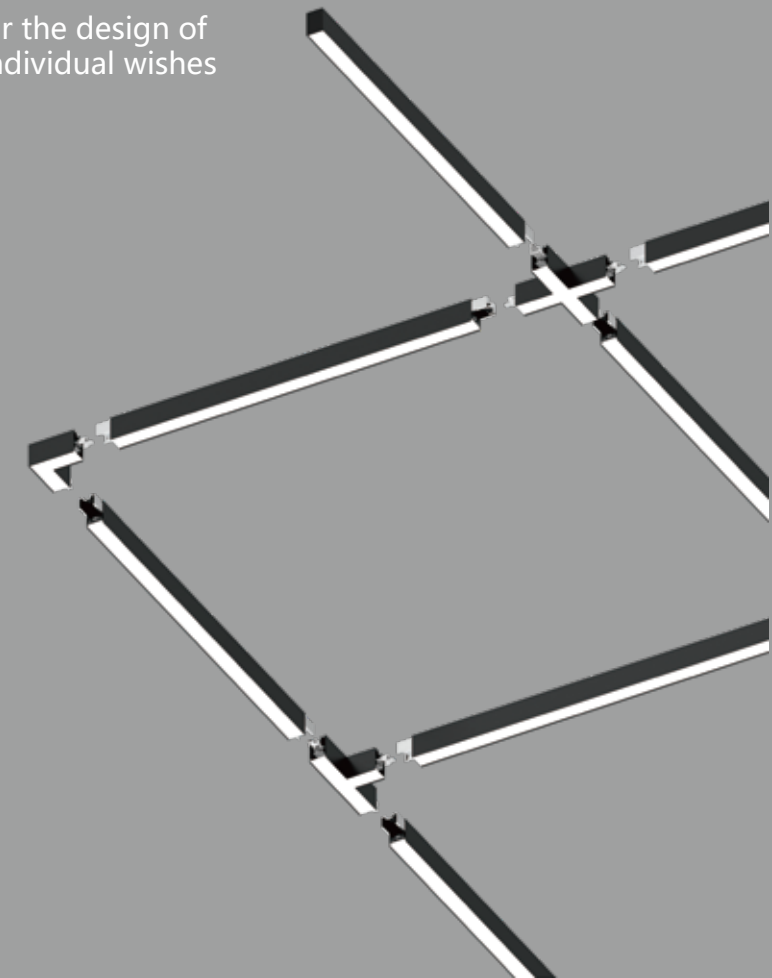



# Design Profile

Suspension rope  
with mounting accessories



## Optionales Up-Light

Indirect lighting as UpLight, which creates pleasantly soft ambient lighting and makes rooms appear larger.

## UP light diffuser

Frosted diffuser as standard

## Aluminum Base

Black / White / Gray color are Available .

## Function Box

Electric feed, including suspension cable



CCT Switch & Wattage Switch

## End caps

to end the several lights or single light

## LED Driver

DALI / 1-10V / EM /MS function as options

## LED Strip

Connection of several lights to a individual shape via connector and included connection accessories

## Variety of Diffuser Options

Prismatic / Honeycomb / Frosted / Reflector , as options , flexible for different request .

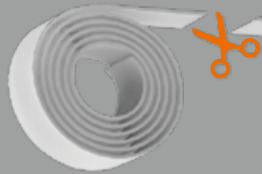

## Flexible, customizable cover

optionally available as a 5 or 10 m roll for productiona seamless light transition

# Polo Suspend Linear

## Polo Suspend Linear LL400

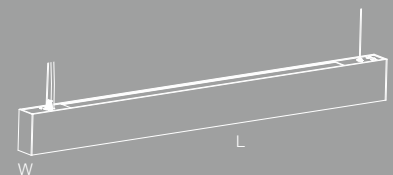

Polo suspend linear is a UP/down linear lighting which has various of function on the junction box on the ceiling Direct/indirect lighting combination, CCT adjustable, emergency and sensor function. Application for resident, commercial, office, educational, architectural, decorative.



### Features

- > Separate control of the direct and indirect light.
- > 120cm 36W Down+6W Up, 150cm 50W Down+6W Up
- > Constructed by Aluminum for heating dispatching
- > 3 steps switch for Tri-color option
- > The driver, EM kits, Sensor is built-in the junction box
- > Easy Installation

### ▶ CCT



### ▶ Function



### ▶ Electrical Parameters



### ▶ Photometric Parameters



### ▶ Finish



### ▶ Data Sheet

Order Code	Rated Power	Lumen	LM/W	Flicker Free	Dimension (mm)	GW/CTN	QTY/CTN
LL400-04W-SN1-36F01-00	36W	typ.3780	typ.105	Y	L1122 X W40 X H100	15.7kg	5pcs
LL400-04W-SN1-50F01-00	50W	typ.5250	typ.105	Y	L1122 X W40 X H100	15.7kg	5pcs
LL400-05W-SN1-50F01-00	50W	typ.5250	typ.105	Y	L1422 X W40 X H100	19.7kg	5pcs



# Design Profile



**Push Fit Terminals**  
Providing hassle free and quick installations

**LiFePO4 -IRON BATTERIES**  
-3 hours Emergency Operation

## Emergency Indicator

A visible indicator to highlight the lights battery back up status.

**End Cap**



**LED Strip**

## Emergency Converter

Ensures there is lighting in case of emergency

## Piano Key Terminals

For easy wiring and quick installation

**Gear Tray**

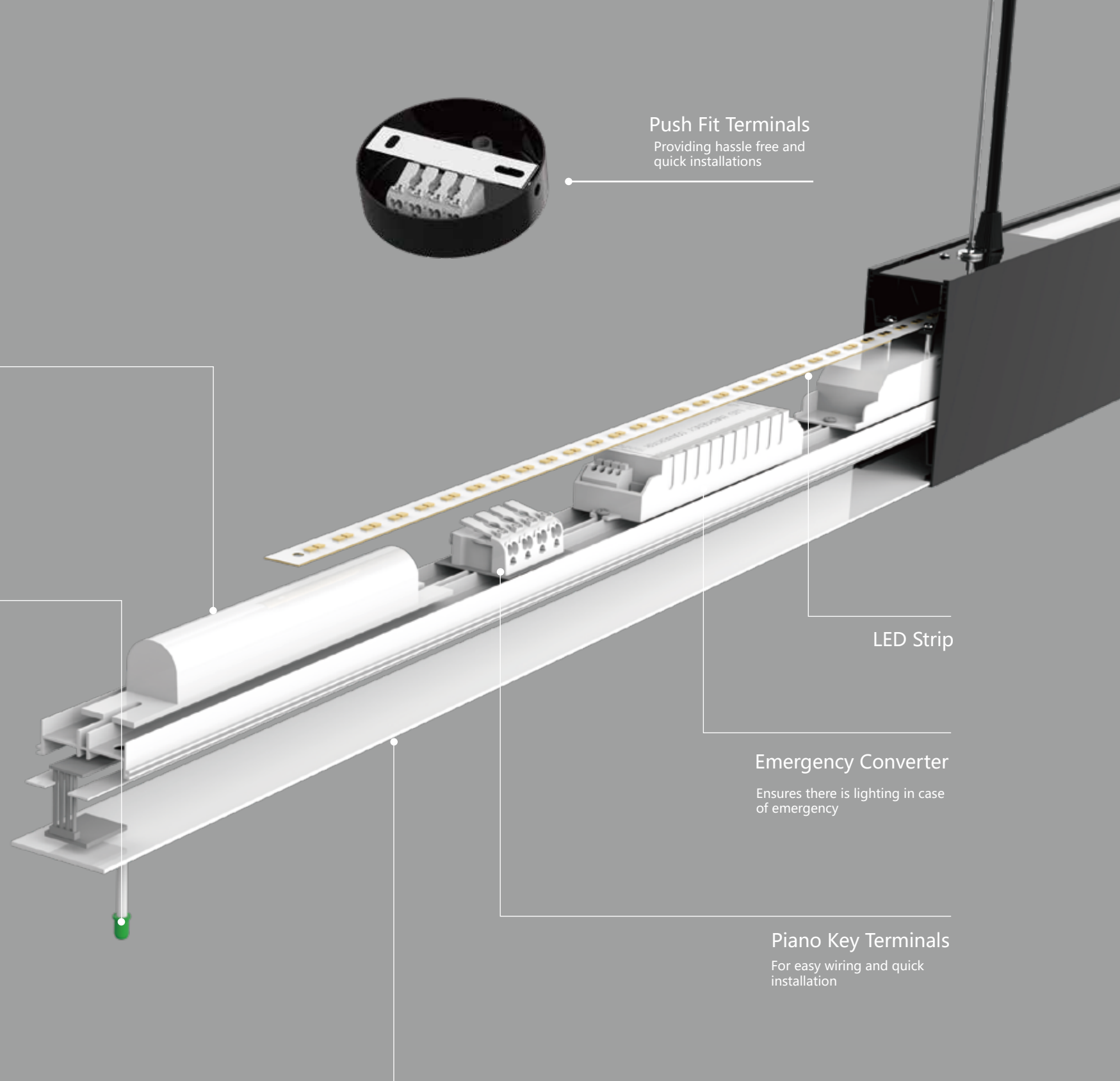



## T8 Slim Batten

BT200

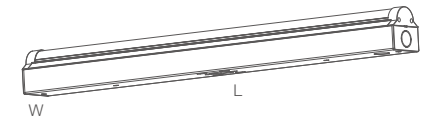

The T8 slim batten have super simple construction and superior capability, with milky, PC diffuser achieves anti-glare and high light transmittance. It is high efficient product with quite large potential market. Integrated 3CCTs to provide flexibility to customer. 4 standard sizes are replacement for T8/T5 fluorescent fitting perfectly.

### ► Features

- > Patent design for T8 fluorescent fitting
- > End or rear cable entry
- > Multiple Link through end rear
- > Easy installation
- > 5 years warranty

### ► Data Sheet

Order Code	Rated Power	Lumen	LM/W	Flicker Free	Dimension (mm)	GW/CTN	QTY/CTN
BT200-02W-DN1-10F01-00	10W	typ.1600	typ.160	Y	L600 X W55 X H58	6.4kg	10pcs
BT200-04W-DN1-17F01-00	17W	typ.2720	typ.160	Y	L1200 X W55 X H58	11.3kg	10pcs
BT200-04W-DN1-32F01-00	32W	typ.5120	typ.160	Y	L1200 X W55 X H58	11.3kg	10pcs
BT200-05W-DN1-28F01-00	28W	typ.4480	typ.160	Y	L1500 X W55 X H58	14.5kg	10pcs
BT200-05W-DN1-56F01-00	56W	typ.8960	typ.160	Y	L1500 X W55 X H58	14.5kg	10pcs
BT200-06W-DN1-32F01-00	32W	typ.5120	typ.160	Y	L1800 X W55 X H58	17.8kg	10pcs
BT200-06W-DN1-62F01-00	62W	typ.9920	typ.160	Y	L1800 X W55 X H58	17.8kg	10pcs

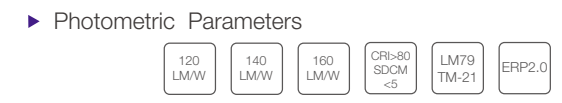
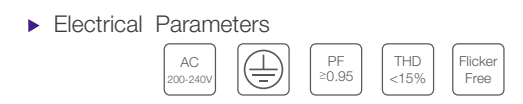

Finish \_\_\_\_\_





## Narrow Slim Batten

BT202

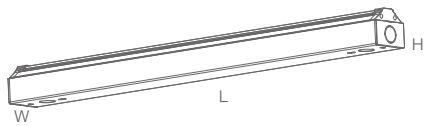

Narrow slim batten is offers a homogeneous light output and has a slim housing. 80 degree beam angle focus on the light area, widely used warehouse, corridor, office, factories, supermarkets, etc. It offers ultra-high efficiency up to 160lm/w utilising latest LED chip technology.

### Features

- > Own design for traditional fluorescent batten
- > End or rear cable entry
- > Multiple Link through end hole
- > Easy installation
- > 5 years warranty

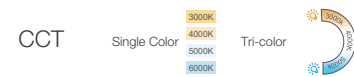

### Electrical Parameters



### Photometric Parameters

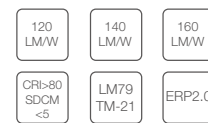

### Data Sheet

Order Code	Rated Power	Lumen	LM/W	Flicker Free	Dimension (mm)	GW/CTN	QTY/CTN
BT202-04W-DN1-17F01-00	17W	typ.2720	typ.160	Y	L1200 X W55 X H50	11.3kg	10pcs
BT202-04W-DN1-32F01-00	32W	typ.5120	typ.160	Y	L1200 X W55 X H50	11.3kg	10pcs
BT202-05W-DN1-28F01-00	28W	typ.4480	typ.160	Y	L1500 X W55 X H50	14.5kg	10pcs
BT202-05W-DN1-56F01-00	56W	typ.8960	typ.160	Y	L1500 X W55 X H50	14.5kg	10pcs
BT202-06W-DN1-32F01-00	32W	typ.5120	typ.160	Y	L1800 X W55 X H50	17.8kg	10pcs
BT202-06W-DN1-62F01-00	62W	typ.9920	typ.160	Y	L1800 X W55 X H50	17.8kg	10pcs
BT202-06W-DN1-72F01-00	72W	typ.11520	typ.160	Y	L1800 X W55 X H50	17.8kg	10pcs



## Frosted Slim Batten

BT203

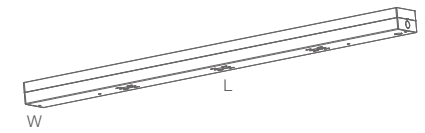

Frosted slim batten is a perfect replacement for traditional light. Aluminum housing provides an excellent thermal management. Opal PC diffuser provide high transparency. Excellent appearance is suitable for various high-end offices, hotel lobbies, conference rooms, classrooms.

### Features

- > Own design for traditional fluorescent batten
- > End or rear cable entry
- > Multiple Link through end hole
- > Easy installation
- > 5 years warranty

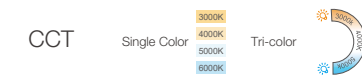

### Electrical Parameters



### Photometric Parameters



### Data Sheet

Order Code	Rated Power	Lumen	LM/W	Flicker Free	Dimension (mm)	GW/CTN	QTY/CTN
BT203-02W-DN1-10F01-00	10W	typ.1600	typ.160	Y	L600 X W55 X H64	5.8kg	8pcs
BT203-04W-DN1-17F01-00	17W	typ.2720	typ.160	Y	L1200 X W55 X H64	11.5kg	8pcs
BT203-04W-DN1-32F01-00	32W	typ.5120	typ.160	Y	L1200 X W55 X H64	11.5kg	8pcs
BT203-05W-DN1-28F01-00	28W	typ.4480	typ.160	Y	L1500 X W55 X H64	14.5kg	8pcs
BT203-05W-DN1-56F01-00	56W	typ.8960	typ.160	Y	L1500 X W55 X H64	14.5kg	8pcs
BT203-06W-DN1-32F01-00	32W	typ.5120	typ.160	Y	L1800 X W55 X H64	17.0kg	8pcs
BT203-06W-DN1-62F01-00	62W	typ.9920	typ.160	Y	L1800 X W55 X H64	17.0kg	8pcs

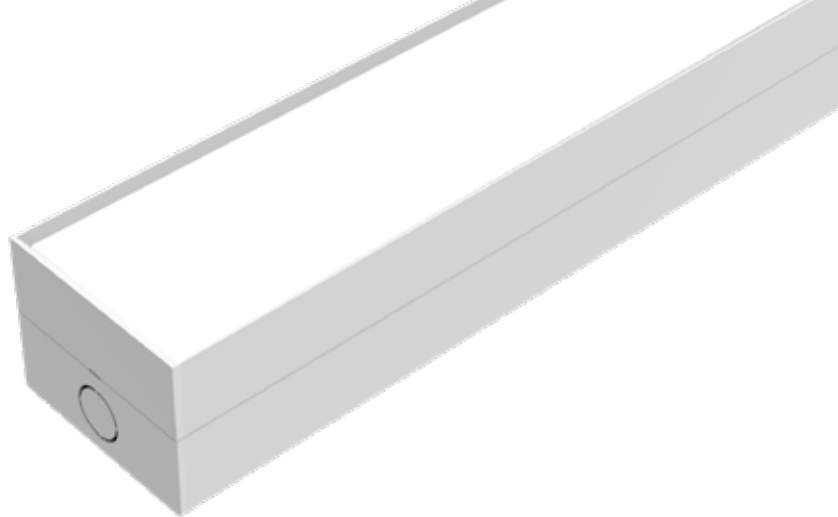

## Upton Frosted

BT210 | 80mm

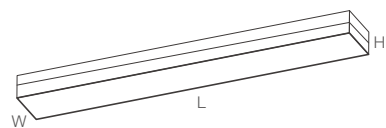

Frosted batten is a perfect replacement for traditional light. Aluminum housing provides an excellent thermal management. Opal PS diffuser provide high transparency. Excellent appearance is suitable for various high-end offices, hotel lobbies, conference rooms, classrooms.

### Features

- > Own design for traditional fluorescent batten
- > End or rear cable entry
- > Multiple Link through end hole
- > Easy installation
- > 5 years warranty

### Data Sheet

Order Code	Rated Power	Lumen	LM/W	Flicker Free	Dimension (mm)	GW/CTN	QTY/CTN
BT210-02W-KN1-10F01-00	10W	typ.1200	typ.120	Y	L600 X W80 X H64	7.0kg	6pcs
BT210-04W-KN1-17F01-00	17W	typ.2040	typ.120	Y	L1200 X W80 X H64	12.0kg	6pcs
BT210-04W-KN1-34F01-00	34W	typ.4080	typ.120	Y	L1200 X W80 X H64	12.0kg	6pcs
BT210-05W-KN1-22F01-00	22W	typ.2640	typ.120	Y	L1500 X W80 X H64	14.0kg	6pcs
BT210-05W-KN1-40F01-00	40W	typ.4800	typ.120	Y	L1500 X W80 X H64	14.0kg	6pcs
BT210-06W-KN1-27F01-00	27W	typ.3240	typ.120	Y	L1800 X W80 X H64	18.0kg	6pcs
BT210-06W-KN1-50F01-00	50W	typ.6000	typ.120	Y	L1800 X W80 X H64	18.0kg	6pcs

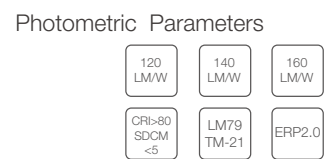
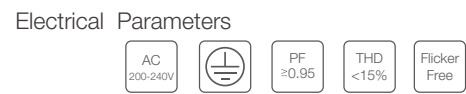

## Kingston Frosted

BT220 | 120mm

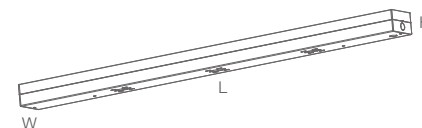

Frosted batten is a perfect replacement for traditional light. Aluminum housing provides an excellent thermal management. Opal PS diffuser provide high transparency. Excellent appearance is suitable for various high-end offices, hotel lobbies, conference rooms, classrooms.

### Features

- > Own design for traditional fluorescent batten
- > End or rear cable entry
- > Multiple Link through end hole
- > Easy installation
- > 5 years warranty

### Data Sheet

Order Code	Rated Power	Lumen	LM/W	Flicker Free	Dimension (mm)	GW/CTN	QTY/CTN
BT220-02W-KN1-10F01-00	10W	typ.1200	typ.120	Y	L600 X W120 X H64	7.0kg	4pcs
BT220-04W-KN1-17F01-00	17W	typ.2040	typ.120	Y	L1200 X W120 X H64	10.5kg	4pcs
BT220-04W-KN1-34F01-00	34W	typ.4080	typ.120	Y	L1200 X W120 X H64	10.5kg	4pcs
BT220-04W-KN1-22F01-00	22W	typ.2640	typ.120	Y	L1500 X W120 X H64	13.0kg	4pcs
BT220-05W-KN1-40F01-00	40W	typ.4800	typ.120	Y	L1500 X W120 X H64	13.0kg	4pcs
BT220-06W-KN1-27F01-00	27W	typ.3240	typ.120	Y	L1800 X W120 X H64	15.5kg	4pcs
BT220-06W-KN1-50F01-00	50W	typ.6000	typ.120	Y	L1800 X W120 X H64	15.5kg	4pcs

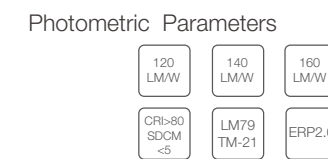
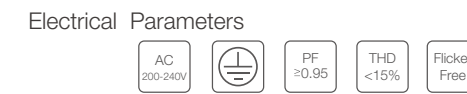



## Hilton Frosted

BT230 | 150mm

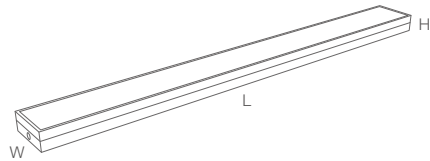

Frosted batten is a perfect replacement for traditional light. Aluminum housing provides an excellent thermal management. Opal PS diffuser provide high transparency. Excellent appearance is suitable for various high-end offices, hotel lobbies, conference rooms, classrooms.

### Features

- > Own design for traditional fluorescent batten
- > End or rear cable entry
- > Multiple Link through end hole
- > Easy installation
- > 5 years warranty

### Data Sheet

Order Code	Rated Power	Lumen	LM/W	Flicker Free	Dimension (mm)	GW/CTN	QTY/CTN
BT230-02W-KN1-10F01-00	10W	typ.1200	typ.120	Y	L600 X W150 X H64	7.0kg	6pcs
BT230-04W-KN1-17F01-00	17W	typ.2040	typ.120	Y	L1200 X W150 X H64	12.0kg	6pcs
BT230-04W-KN1-34F01-00	34W	typ.4080	typ.120	Y	L1200 X W150 X H64	12.0kg	6pcs
BT230-05W-KN1-22F01-00	22W	typ.2640	typ.120	Y	L1500 X W150 X H64	14.0kg	6pcs
BT230-05W-KN1-40F01-00	40W	typ.4800	typ.120	Y	L1500 X W150 X H64	14.0kg	6pcs
BT230-06W-KN1-27F01-00	27W	typ.3240	typ.120	Y	L1800 X W150 X H64	18.0kg	6pcs
BT230-06W-KN1-50F01-00	50W	typ.6000	typ.120	Y	L1800 X W150 X H64	18.0kg	6pcs

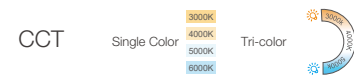

### Electrical Parameters



### Photometric Parameters

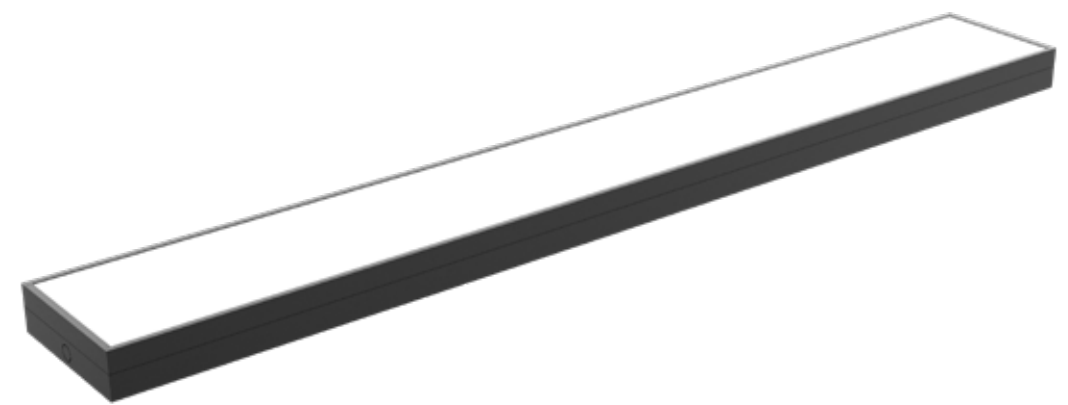
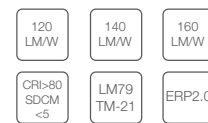

## Kaston Frosted

BT240 | 200mm

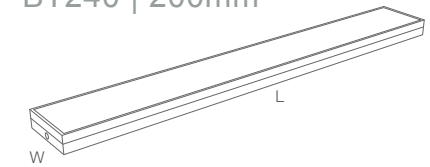

Frosted batten is a perfect replacement for traditional light. Aluminum housing provides an excellent thermal management. Opal PS diffuser provide high transparency. Excellent appearance is suitable for various high-end offices, hotel lobbies, conference rooms, classrooms.

### Features

- > Own design for traditional fluorescent batten
- > End or rear cable entry
- > Multiple Link through end hole
- > Easy installation
- > 5 years warranty

### Data Sheet

Order Code	Rated Power	Lumen	LM/W	Flicker Free	Dimension (mm)	GW/CTN	QTY/CTN
BT240-02W-KN1-10F01-00	10W	typ.1200	typ.120	Y	L600 X W200 X H64	7.0kg	4pcs
BT240-04W-KN1-17F01-00	17W	typ.2040	typ.120	Y	L1200 X W200 X H64	10.5kg	4pcs
BT240-04W-KN1-34F01-00	34W	typ.4080	typ.120	Y	L1200 X W200 X H64	10.5kg	4pcs
BT240-04W-KN1-22F01-00	22W	typ.2640	typ.120	Y	L1500 X W200 X H64	13.0kg	4pcs
BT240-05W-KN1-40F01-00	40W	typ.4800	typ.120	Y	L1500 X W200 X H64	13.0kg	4pcs
BT240-06W-KN1-27F01-00	27W	typ.3240	typ.120	Y	L1800 X W200 X H64	15.5kg	4pcs
BT240-06W-KN1-50F01-00	50W	typ.6000	typ.120	Y	L1800 X W200 X H64	15.5kg	4pcs

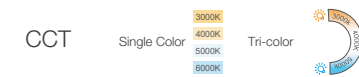

### Electrical Parameters



### Photometric Parameters







# Wega Batten

BT330

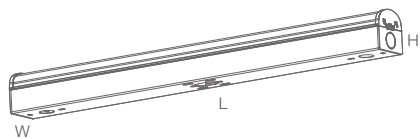

Safety-lock-mechanism design for quick installation. Osram driver as standard and adopts SMD high lumen efficiency 160LM/W is good lighting solution. The iron lamp body provides excellent heat dissipation.

## Features

- > High lumen efficiency – up to 160lm/w
- > Safety-lock-mechanism for a secure installation
- > Durable sheet-metal casing with end/rear cables entries
- > Milky PC cover with 85% transparency and 120° beam angle
- > Suitable for surface mounting or suspended installation
- > Perfect replacement for traditional T5/T8 fittings
- > OSRAM driver as standard
- > 5 year warranty



## Electrical Parameters



## Photometric Parameters



# General Batten

BT310

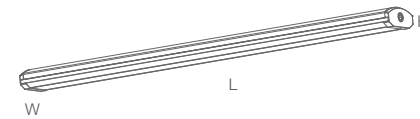

General Batten adopts separated module design, has been improved to have a wider lighting emitting area. Color temperature and wattage both switchable. Mounting design: suspension/surface mounting

## Features

- > Various of functions for options
- > High lumen output at 160LM/W
- > Easy Installation
- > 5 years warranty



## Electrical Parameters



## Photometric Parameters



## Data Sheet

Order Code	Rated Power	Lumen	LM/W	Flicker Free	Dimension (mm)	GW/CTN	QTY/CTN
BT330-02W-DN1-10F01-00	10W	typ.1600	typ.160	Y	L600 X W55 X H59	7.5kg	10pcs
BT330-04W-DN1-18F01-00	18W	typ.2880	typ.160	Y	L1200 X W55 X H59	12.4kg	10pcs
BT330-04W-DN1-35F01-00	35W	typ.5600	typ.160	Y	L1200 X W55 X H59	12.4kg	10pcs
BT330-05W-DN1-29F01-00	29W	typ.4640	typ.160	Y	L1500 X W55 X H59	14.5kg	10pcs
BT330-05W-DN1-55F01-00	55W	typ.8800	typ.160	Y	L1500 X W55 X H59	15.5kg	10pcs
BT330-06W-DN1-35F01-00	35W	typ.5600	typ.160	Y	L1800 X W55 X H59	18.8kg	10pcs
BT330-06W-DN1-55F01-00	55W	typ.8800	typ.160	Y	L1800 X W55 X H59	18.8kg	10pcs

## Data Sheet

Order Code	Rated Power	Lumen	LM/W	Flicker Free	Dimension (mm)	GW/CTN	QTY/CTN
BT310-04W-DT1-17F01-00	17W	typ.2720	typ.160	Y	L1200 X W152 X H77	9.2kg	4pcs
BT310-04W-DT1-32F01-00	32W	typ.5120	typ.160	Y	L1200 X W152 X H77	9.2kg	4pcs
BT310-05W-DT1-25F01-00	25W	typ.4000	typ.160	Y	L1500 X W152 X H77	11.2kg	4pcs
BT310-05W-DT1-50F01-00	50W	typ.8000	typ.160	Y	L1500 X W152 X H77	11.2kg	4pcs



## TX Batten

BT320

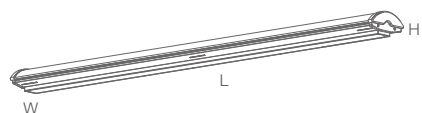

TX Batten adopts unique module design to have a wide lighting emitting area, the semi-circular shape makes it emit a uniform light effect, bringing a high-level texture. Color temperature and wattage both switchable. Suspension/surface mounting designed for school lighting, office lighting applications, etc.

### Features

- > Various of functions for options
- > High lumen output at 160LM/W
- > Easy Installation
- > 5 years warranty

### Data Sheet

Order Code	Rated Power	Lumen	LM/W	Flicker Free	Dimension (mm)	GW/CTN	QTY/CTN
BT320-04W-DN1-20F01-00	20W	typ.3200	typ.160	Y	L1190 X W165 X H75	11.8kg	5pcs
BT320-04W-DN1-34 F01-00	34W	typ.5440	typ.160	Y	L1190 X W165 X H75	11.8kg	5pcs
BT320-05W-DN1-24F01-00	24W	typ.3840	typ.160	Y	L1470 X W165 X H75	14.0kg	5pcs
BT320-05W-DN1-40F01-00	40W	typ.6400	typ.160	Y	L1470 X W165 X H75	14.0kg	5pcs
BT320-06W-DN1-32F01-00	32W	typ.5120	typ.160	Y	L1800 X W165 X H75	17.7kg	5pcs
BT320-06W-DN1-50F01-00	50W	typ.8000	typ.160	Y	L1800 X W165 X H75	17.7kg	5pcs



## Grid Batten

BT340

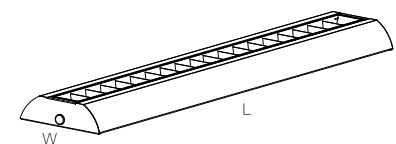

### Electrical Parameters



### Photometric Parameters

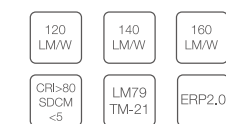

Grid batten use the special designed steel grid to make the UGR data. It is the best LED module to replace the similar traditional light.

### Features

- > Various of functions for options
- > High lumen output at 160LM/W
- > Easy Installation
- > 5 years warranty

### Data Sheet

Order Code	Rated Power	Lumen	LM/W	Flicker Free	Dimension (mm)	GW/CTN	QTY/CTN
BT340-04W-PN1-35F01-00	21-35W	2150-4900	typ.140	Y	L1200 X W200 X H55	23.5kg	5pcs
BT340-04W-PN1-40F01-00	23-40W	3650-5600	typ.140	Y	L1500 X W200 X H55	23.5kg	5pcs

# Arco Batten

BT300



Arco batten is a extra wide body LED batten featuring an aesthetically pleasing low-glare design , The arco batten has a multiple function ,All of these special design make the arco batten is a best replacement for the traditional fluorescent college fitting

The arco batten were widely use in offices, universities colleges, schools, hospitals.

## Features

- > College Fitting / College Batten
- > 0.7mm steel case +1.8mm TP(b) cover
- > Safety lock to prevent accidental opening
- > Various of functions for options
- > High lumen output at 160LM/W
- > Rotatable end cap for easy opening and installation
- > 5 years warranty

Polycarbonate Diffuser End Cap



Frosted Polycarbonate Diffuser

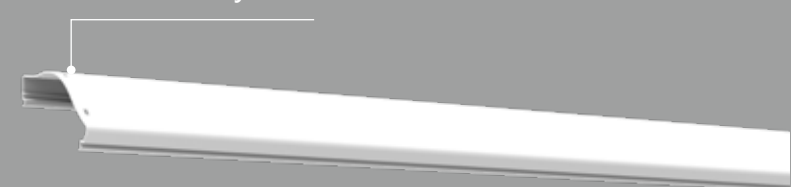

CCT Switch

With DIP switch



Wiring Terminals

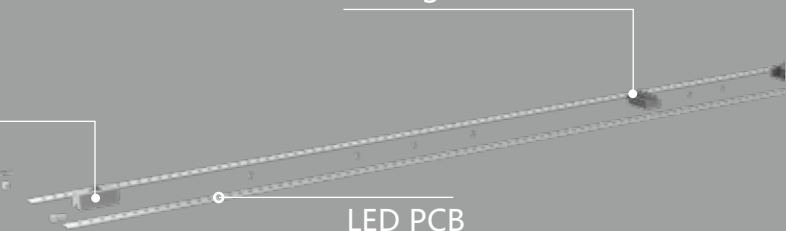

LED PCB

Base End Cap

With conduit knockouts holes(20mm)

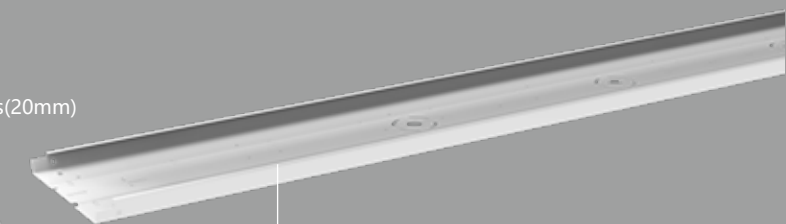

Steel Base with BESA

## ► Data Sheet

Order Code	Rated Power	Lumen	LM/W	Flicker Free	Dimension (mm)	GW/CTN	QTY/CTN
BT300-04W-DT1-17F01-00	17W	typ.1600	typ.160	Y	L1200 X W215 X H77	17.5kg	5pcs
BT300-04W-DT1-32F01-00	32W	typ.5120	typ.160	Y	L1200 X W215 X H77	17.5kg	5pcs
BT300-05W-DT1-25F01-00	25W	typ.4000	typ.160	Y	L1500 X W215 X H77	21.6kg	5pcs
BT300-05W-DT1-50F01-00	50W	typ.8000	typ.160	Y	L1500 X W215 X H77	21.6kg	5pcs
BT300-05W-DT1-60F01-00	60W	typ.9600	typ.160	Y	L1500 X W215 X H77	21.6kg	5pcs

## ► CCT

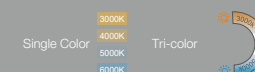

## ► Electrical Parameters



## ► Function



## ► Photometric Parameters

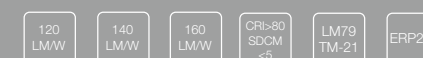



## Recessed UGR Batten

LL602

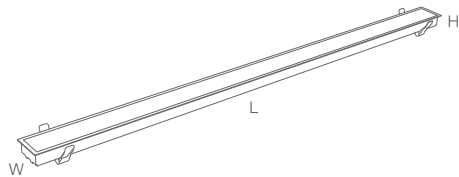

Recessed Batten provides clean lines of light with a simple easy-to-use design. It sits flush to the surface and are ideal for under-cabinet lighting, toe kick lighting, area lighting, wall and ceiling inset lighting.

### ► Features

- > Surface linear suitable for educational and commercial applications
- > Aluminium body with polycarbonate diffuser and plastic end caps
- > Installation clips easy for Plaster Ceiling installation



- CCT
  - Single Color: 3000K, 4000K, 5000K, 6000K
  - Tri-color: 3000K, 4000K, 5000K, 6000K
- Function
  - ON/OFF
  - PIR
  - DALI
  - Emergency
- Electrical Parameters
  - AC 200-240V
  - PF ≥0.95
  - THD <15%
  - Flicker Free
- Photometric Parameters
  - 110 LM/W
  - CRi>80 SDCM <5
  - LM79 TM-21
  - ERP2.0

### ► Data Sheet

Order Code	Rated Power	Lumen	LM/W	Flicker Free	Dimension (mm)	GW/CTN	QTY/CTN
TP-LL602-04W-KT1-36F01-01	36W	typ.3960	typ.110	Y	L1209 X W68 X H30.5	9.3kg	10pcs
TP-LL602-05W-KT1-48F01-01	48W	typ.5200	typ.110	Y	L1509 X W68 X H30.5	11.6kg	10pcs

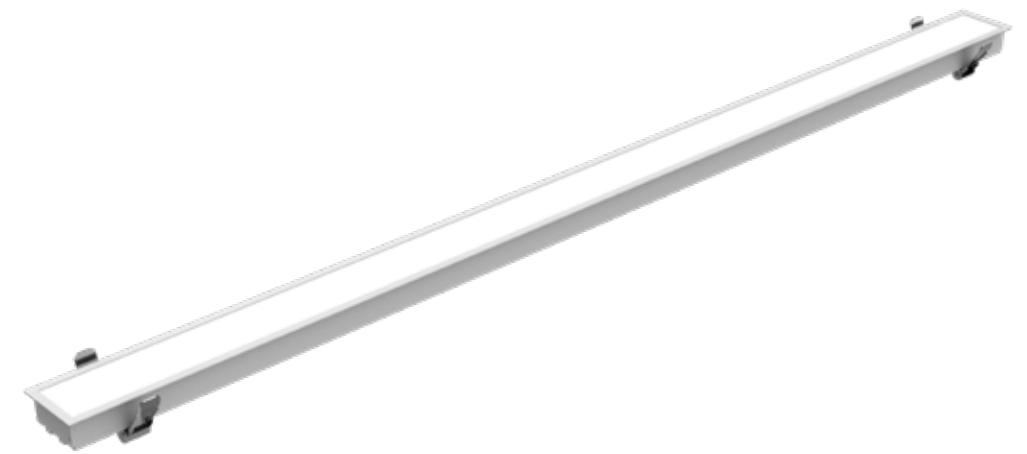

## Recessed Frosted Batten

LL601

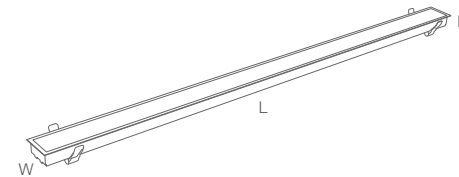

Recessed Batten provides clean lines of light with a simple easy-to-use design. It sits flush to the surface and are ideal for under-cabinet lighting, toe kick lighting, area lighting, wall and ceiling inset lighting.

### ► Features

- > Surface linear suitable for educational and commercial applications
- > Aluminium body with polycarbonate diffuser and plastic end caps
- > Installation clips easy for Plaster Ceiling installation



- CCT
  - Single Color: 3000K, 4000K, 5000K, 6000K
  - Tri-color: 3000K, 4000K, 5000K, 6000K
- Function
  - ON/OFF
  - PIR
  - DALI
  - Emergency
- Electrical Parameters
  - AC 200-240V
  - PF ≥0.95
  - THD <15%
  - Flicker Free
- Photometric Parameters
  - 110 LM/W
  - CRi>80 SDCM <5
  - LM79 TM-21
  - ERP2.0

### ► Data Sheet

Order Code	Rated Power	Lumen	LM/W	Flicker Free	Dimension (mm)	GW/CTN	QTY/CTN
TP-LL601-04W-KT1-36F01-01	36W	typ.3960	typ.110	Y	L1209 X W68 X H30.5	9.3kg	10pcs
TP-LL601-05W-KT1-48F01-01	48W	typ.5200	typ.110	Y	L1509 X W68 X H30.5	11.6kg	10pcs





Beam Angle : 30/60/90/LR25 Degree

Traditional trunk complete with

Compatible with various brands traditional trunks  
Width: Max 68mm, Min 42mm

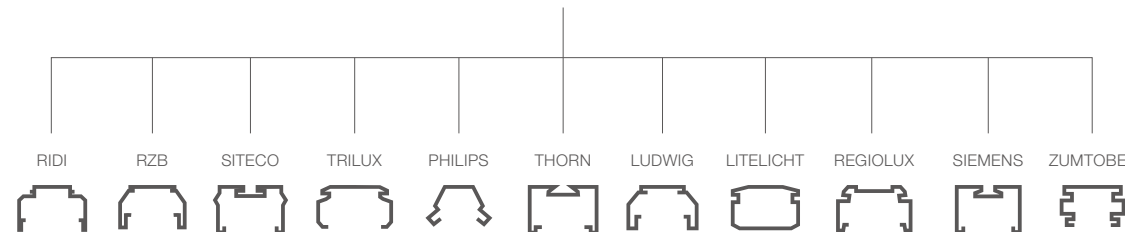

Connection Method

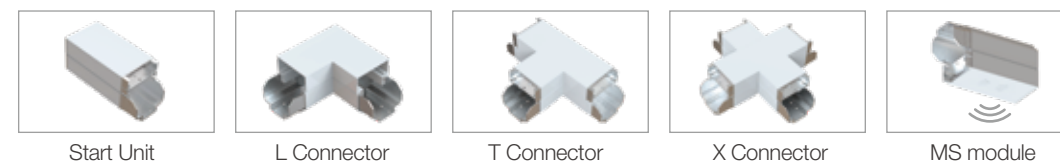

Trunk rail and Blank cover ( IINNO Standard )

For the applications have no the traditional trunk or the new buildings . IINNO can provide the standard trunk for the retro flex lighting module . And also, We provide the blank cover for the additional balance length for the installation

Trunk Rail

Product Picture	Order Code	Product Name	Dimension (mm)	Dimension drawing
	RM-TR05-00	5ft-150CMM/ Trunk Rail	L1527 X W64.5 X H50	
	RM-TR10 -00	10ft-300CM/ Trunk Rail	L3027 X W64.5 X H50	

Blank cover

Product Picture	Order Code	Product Name	Dimension (mm)	Dimension drawing
	RM-BC01-00	1ft-30CMM/Blank Cover	L327 X W64.5 X H37	
	RM-BC04-00	4ft-120CM/Blank Cover	L1227 X W64.5 X H37	
	RM-BC05-00	5ft-150CMM/Blank Cover	L1527 X W64.5 X H37	

# Retro Flex

LL200 | Honeycomb LL201

| PC Cover

LL202 | Lens 90 degree

LL203 | Lens L/R 25 degree



Retro flex lighting module include pre-wired PC cover (160LM/W)module and honeycomb(125LM/W)module , CLO function makes 7 years warranty ,25-75W adjustable makes stock easy to handle, Tri color suitable for different applications.

## Features

- > Up to 160LM/W@12000LM
- > UGR<19 (honeycomb cover)
- > 400V Switcher for 3-phase AC
- > 5/7 pre-wired system with CLO function
- > Click-Slide system allows the module to be mounted on variety of trunks
- > Tool free installation at MAX 200M multiple link
- > 7 years warranty

## Data Sheet

Order Code	Rated Power	Lumen	LM/W	Flicker Free	Dimension (mm)	GW/CTN	QTY/CTN
LL200-05W-DT1-75F01-00	25-75W	typ.3500-10500	typ.140	Y	L1526 X W106 X H88	21.5kg	8pcs
LL201-05W-CT1-75F01-00	25-75W	typ.4000-12000	typ.160	Y	L1526 X W106 X H88	16.5kg	8pcs
LL202-05W-CT1-75F01-00	25-75W	typ.4000-12000	typ.160	Y	L1526 X W106 X H88	16.5kg	8pcs
LL203-05W-CT1-75F01-00	25-75W	typ.4000-12000	typ.160	Y	L1526 X W106 X H88	16.5kg	8pcs



**CCT** Single Color (3000K, 4000K, 5000K, 6000K) Tri-color (2700K, 4000K, 6000K)

**Function** ON/OFF, 1-10V Dimming, DALI, MS, Emergency

**Electrical Parameters** CLO, AC 100-277V, PF ≥0.95, THD <15%, Flicker Free

**Photometric Parameters** 140 LM/W, 160 LM/W, CRb-80 SDCM <5, LM79 TM-21, ERP2.0

**Wiring** 5 Wires, 7 Wires

**Finish** White, Gray, Black



# Design Profile



Each universal module enable tool-free 7-level power regulation via DIP switch: 25W-35W-40W-45W-55W-65W-75W



The newly developed LED driver regulates the luminous flux intelligently and automatically. In this way is constant over the entire service life Light level guaranteed and economical operation secured.



The unique soft start technology reduces high inrush currents and saves money. it protects electrical components and thus extends the operating time and service life



CCT Switch enables the selection the desired color temperature (3000 K - 4000 K - 5000 K) simply select using the DIP switch.



▲L1 ▲L2 ▲L3

The 400V /3-phase AC switcher makes the Retro Flex Module can be max 200 meters multiple linking  
Tool-free phase selection, this saves you a rewiring and thus valuable time.



Safety rope hanging board

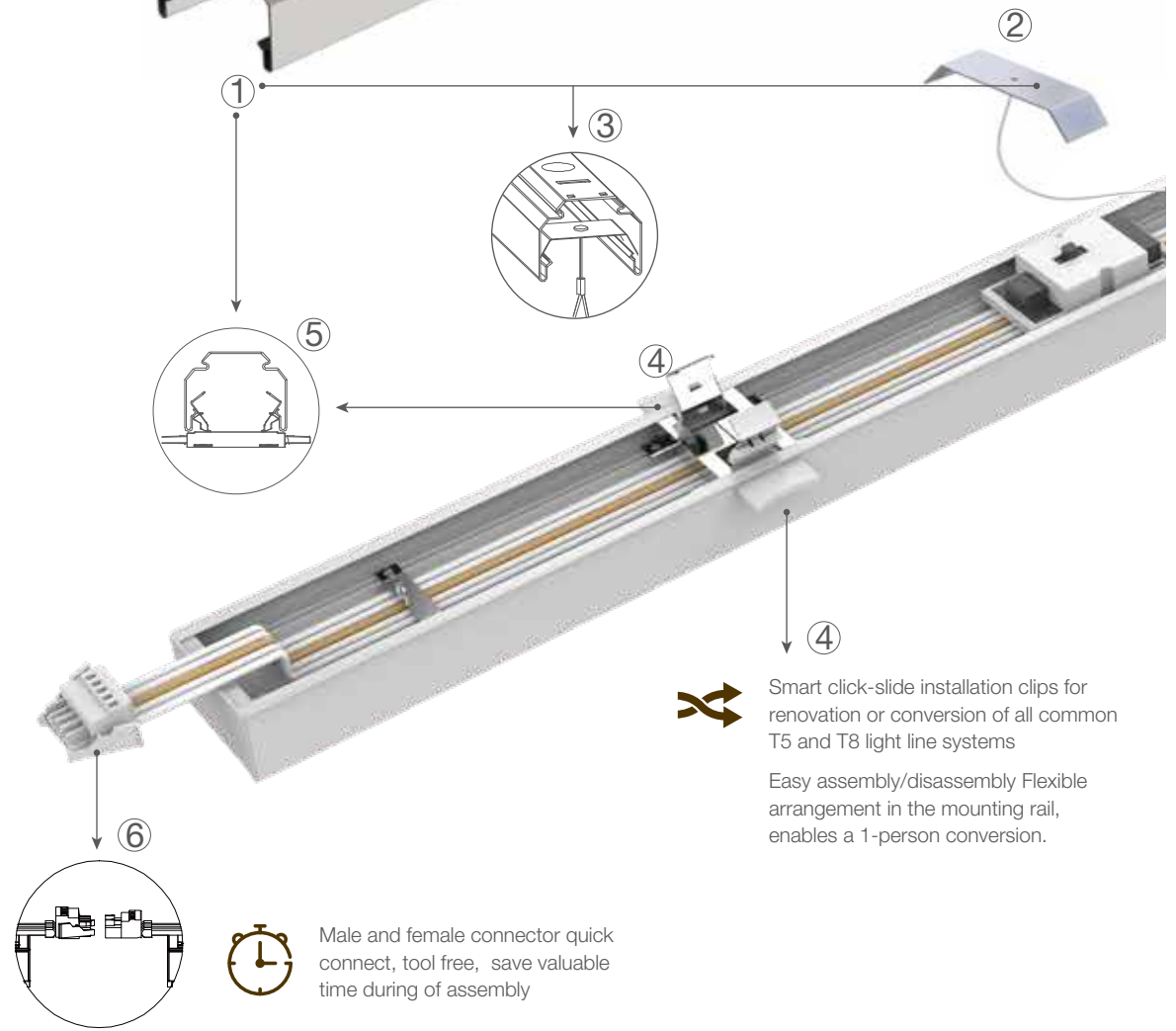

Smart click-slide installation clips for renovation or conversion of all common T5 and T8 light line systems  
Easy assembly/disassembly Flexible arrangement in the mounting rail, enables a 1-person conversion.



Male and female connector quick connect, tool free, save valuable time during of assembly

# Installation/connection method



Quick Connect Clip

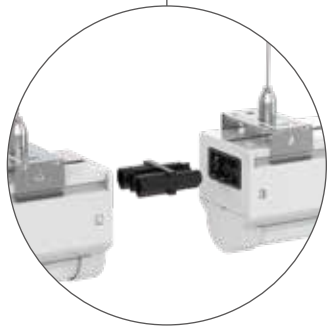

Fast Connector

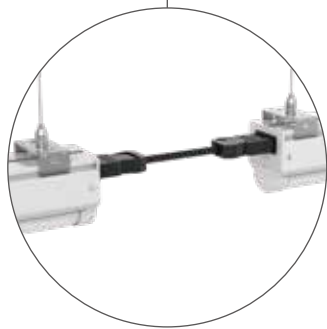

## Pro-Line

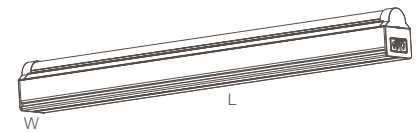

Pro-Line is a complete LED solutions designed for shelf led lighting by Magnet tool free installation. And it's also widely used in the office /commercial / industrial / education applications. The batters can be connected through the end by quick Wieland connector. This allows end to end continuous tool free installation.

### ► Features

- > Up to 160lm/W
- > Quick Wieland Connector For Multiple Link
- > Magnet tool-free Installation / Surface Mounted / Suspension
- > 5 years warranty

- CCT
  - Single Color: 3000K, 4000K, 5000K, 6000K
  - Tri-color: 3000K, 4000K, 5000K
- Function
  - ON/OFF
  - PR (Presence Recognition)
- Electrical Parameters
  - AC 200-240V
  - PF ≥0.95
  - THD <15%
  - Flicker Free
- Photometric Parameters
  - 120 LM/W
  - 140 LM/W
  - 160 LM/W
  - CRI>80 SDCM <5
  - LM79 TM-21
  - ERP2.0
- Wiring
  - Double wiring
- Finish
  - White
  - Gray
  - Black

### ► T8 Module (120°)

Order Code	Rated Power	Lumen	LM/W	Flicker Free	Dimension (mm)	GW/CTN	QTY/CTN
LL307-02W-CN1-10F01-00	10W	typ.1600	typ.160	Y	L600 X W55 X H58	6.4kg	10pcs
LL307-04W-CN1-17F01-00	17W	typ.2720	typ.160	Y	L1200 X W55 X H58	11.3kg	10pcs
LL307-04W-CN1-32F01-00	32W	typ.5120	typ.160	Y	L1200 X W55 X H58	11.3kg	10pcs
LL307-05W-CN1-28F01-00	28W	typ.4480	typ.160	Y	L1500 X W55 X H58	14.5kg	10pcs
LL307-05W-CN1-56F01-00	56W	typ.8960	typ.160	Y	L1500 X W55 X H58	14.5kg	10pcs
LL307-06W-CN1-32F01-00	32W	typ.5120	typ.160	Y	L1800 X W55 X H58	17.8kg	10pcs
LL307-06W-CN1-62F01-00	62W	typ.9920	typ.160	Y	L1800 X W55 X H58	17.8kg	10pcs

## Installation

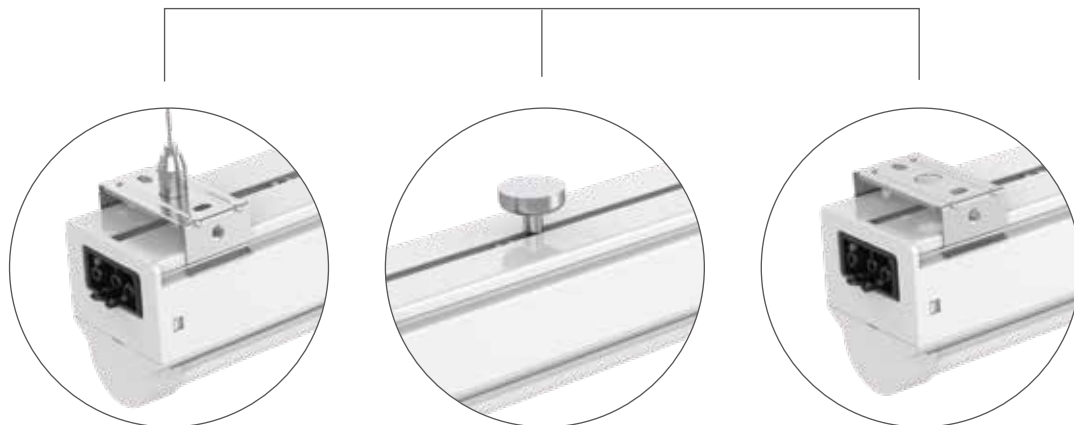

Suspension

Magnet tool free installation

Surface Mounting

► Lens Module (30°/60°/90°/LR25 Optional)

Order Code	Wattage	Lumen	LM/W	Flicker Free	Dimension (mm)	GW/CTN	QTY/CTN
LL300-02W-CN1-10F01-00	10W	typ.1600	typ.160	Y	L600 X W55 X H63.5	6.8kg	8pcs
LL300-04W-CN1-17F01-00	17W	typ.2720	typ.160	Y	L1200 X W55 X H63.5	12.5kg	8pcs
LL300-04W-CN1-32F01-00	32W	typ.5120	typ.160	Y	L1200 X W55 X H63.5	12.5kg	8pcs
LL300-05W-CN1-28F01-00	28W	typ.4480	typ.160	Y	L1500 X W55 X H63.5	15.5kg	8pcs
LL300-05W-CN1-56F01-00	56W	typ.8960	typ.160	Y	L1500 X W55 X H63.5	15.5kg	8pcs
LL300-06W-CN1-32F01-00	32W	typ.5120	typ.160	Y	L1800 X W55 X H63.5	18.0kg	8pcs
LL300-06W-CN1-62F01-00	62W	typ.9920	typ.160	Y	L1800 X W55 X H63.5	18.0kg	8pcs

► Frosted Module

Order Code	Rated Power	Lumen	LM/W	Flicker Free	Dimension (mm)	GW/CTN	QTY/CTN
LL304-02W-CN1-10F01-00	10W	typ.1600	typ.160	Y	L600 X W55 X H63.5	5.8kg	8pcs
LL304-04W-CN1-17F01-00	17W	typ.2720	typ.160	Y	L1200 X W55 X H63.5	11.5kg	8pcs
LL304-04W-CN1-32F01-00	32W	typ.5120	typ.160	Y	L1200 X W55 X H63.5	11.5kg	8pcs
LL304-05W-CN1-28F01-00	28W	typ.4480	typ.160	Y	L1500 X W55 X H63.5	14.5kg	8pcs
LL304-05W-CN1-56F01-00	56W	typ.8960	typ.160	Y	L1500 X W55 X H63.5	14.5kg	8pcs
LL304-06W-CN1-32F01-00	32W	typ.5120	typ.160	Y	L1800 X W55 X H63.5	17.0kg	8pcs
LL304-06W-CN1-62F01-00	62W	typ.9920	typ.160	Y	L1800 X W55 X H63.5	17.0kg	8pcs

► Gentle Module (Low glare UGR<22)

Order Code	Rated Power	Lumen	LM/W	Flicker Free	Dimension (mm)	GW/CTN	QTY/CTN
LL305-02W-KN1-10F01-00	10W	typ.1200	typ.120	Y	L605 X W55 X H63.5	6.0kg	8pcs
LL305-04W-KN1-17F01-00	17W	typ.2040	typ.120	Y	L1205 X W55 X H63.5	11.5kg	8pcs
LL305-04W-KN1-34F01-00	34W	typ.4080	typ.120	Y	L1205 X W55 X H63.5	11.5kg	8pcs
LL305-05W-KN1-22F01-00	22W	typ.2640	typ.120	Y	L1505 X W55 X H63.5	14.5kg	8pcs
LL305-05W-KN1-40F01-00	40W	typ.4800	typ.120	Y	L1505 X W55 X H63.5	14.5kg	8pcs
LL305-06W-KN1-27F01-00	27W	typ.3240	typ.120	Y	L1805 X W55 X H63.5	17.0kg	8pcs
LL305-06W-KN1-50F01-00	50W	typ.6000	typ.120	Y	L1805 X W55 X H63.5	17.0kg	8pcs

► Narrow Module (80°)

Order Code	Rated Power	Lumen	LM/W	Flicker Free	Dimension (mm)	GW/CTN	QTY/CTN
LL306-02W-CN1-10F01-00	10W	typ.1600	typ.160	Y	L605 X W55 X H50	5.7kg	10pcs
LL306-04W-CN1-17F01-00	17W	typ.2720	typ.160	Y	L1200 X W55 X H50	11.3kg	10pcs
LL306-04W-CN1-32F01-00	32W	typ.5120	typ.160	Y	L1200 X W55 X H50	11.3kg	10pcs
LL306-05W-CN1-28F01-00	28W	typ.4480	typ.160	Y	L1500 X W55 X H50	14.5kg	10pcs
LL306-05W-CN1-56F01-00	56W	typ.8960	typ.160	Y	L1500 X W55 X H50	14.5kg	10pcs
LL306-06W-CN1-32F01-00	32W	typ.5120	typ.160	Y	L1800 X W55 X H50	17.8kg	10pcs
LL306-06W-CN1-62F01-00	62W	typ.9920	typ.160	Y	L1800 X W55 X H50	17.8kg	10pcs
LL306-06W-CN1-72F01-00	72W	typ.11520	typ.160	Y	L1800 X W55 X H50	17.8kg	10pcs

► Accessory

Order Code	Product name
ASS-WIR-F318FU-1500-00	1500mm EU Plug Connector
ASS-WIR-F318FU-2000-04	2000mm EU Plug Connector
ASS-WIR-F318FU-3000-00	3000mm EU Plug Connector
ASS-WIR-F318FU-0300-01	300mm Male & Female Connector
ASS-WIR-F318FU-0900-01	900mm Male & Female Connector
ASS-WIR-F318FU-1500-01	1500mm Male & Female Connector
ASS-WIR-F315FU-2000-00	2000mm Male & Female Connector

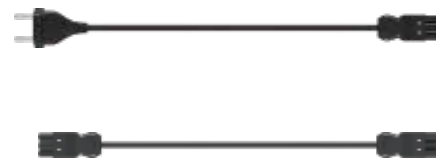



# Fasco Asymmetric

AL100

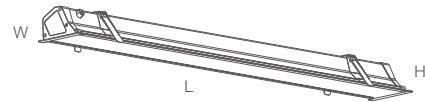

The fasco asymmetric light is a recessed Led light with the milky diffuser, The aluminum heat sink helps the fasco asymmetric light offer a long life time by 5 years warranty.

## Features

- > Aluminum heat sink
- > Special asymmetric design with milky cover
- > Recessed installation
- > 5 years warranty

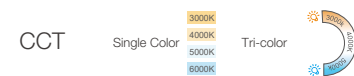

## Electrical Parameters



## Photometric Parameters



## Data Sheet

Order Code	Rated Power	Lumen	LM/W	Cut-out Size (mm)	Dimension (mm)	GW/CTN	QTY/CTN
AL100-04W-PT1-28F01-00	18-28W	typ.2160-3360	typ.120	1175 X 120	L1195 X W140 X H80	13.5kg	4pcs

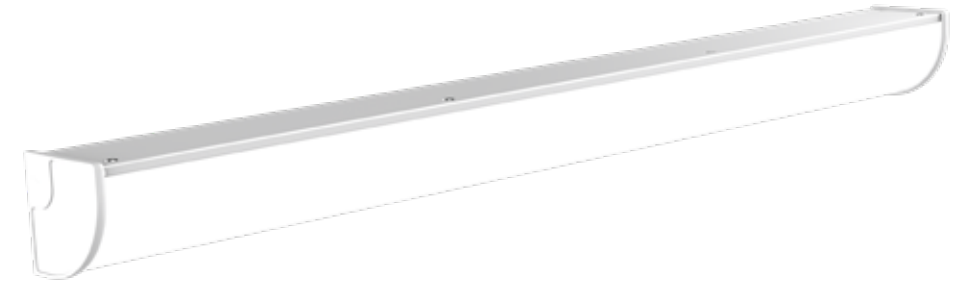

# Dasco Asymmetric

AL200

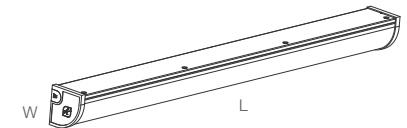

The dasco asymmetric light is a surface mounting Led light with the milky diffuser, The aluminum heat sink helps the dasco asymmetric light offer a long life time by 5 years warranty.

## Features

- > Aluminum heat sink
- > Special asymmetric design with milky cover
- > Surface mounting installation
- > 5 years warranty



## Electrical Parameters



## Photometric Parameters



## Data Sheet

Order Code	Rated Power	Lumen	LM/W	Flicker Free	Dimension (mm)	GW/CTN	QTY/CTN
AL100-04W-DT1-25F01-00	15-25W	typ.2100-3500	typ.140	Y	L1200 X W102.5 X H102.5	13.5kg	4pcs





## Track Asymmetric

AL300

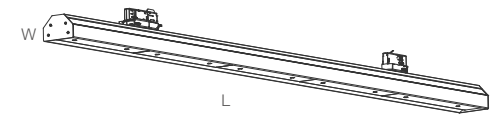

The track asymmetric light is special design which with the track installation, it was widely used on the retail application because it has 2 side lighting emitting .

Aluminum case is an excellent heating sink, the high technology SMD2835 provide a more higher lumen output.

### ► Features

- > Aluminum heat sink
- > Special 2 side lighting
- > Track installation
- > 5 years warranty

### ► Data Sheet

Order Code	Rated Power	Lumen	LM/W	Flicker Free	Dimension (mm)	GW/CTN	QTY/CTN
AL300-04W-CN1-38D01-00	Down 32W+Up 6W	typ.6000	typ.160	Y	L1200 X W86 X H97.5	14kg	4pcs
AL300-05W-CN1-47D01-00	Down 40W+Up 7W	typ.7500	typ.160	Y	L1500 X W86 X H97.5	17kg	4pcs



- CCT
  - Single Color: 3000K, 4000K, 5000K, 6000K
  - Tri-color: 3000K, 4000K, 5000K
- Function
  - ON/OFF
  - 1-10V Dimming
  - DALI
  - MS
  - PIR
  - Emergency
- Electrical Parameters
  - AC 200-240V
  - PF ≥0.95
  - THD <15%
  - Flicker Free
- Photometric Parameters
  - 160 LM/W
  - CRI>80 SDCM <3
  - LM79 TM-21
  - ERP2.0

# Tri-proof Lights

>The aluminum tri-proof lights are a new modern design which with more function options and up to 160LM/W.

>All of aluminum tri-proof lights are IP65 and IK10 protected,the different options make the clients use the aluminum tri-proof lights on differents applications, Such as: Car parks, Factories, ect.



## Categories



Prime Tri-proof  
TR100



Deco Tri-proof  
TR200



Deco S Tri-proof  
TR200



Basic Tri-proof  
TR300



Tubar Light  
TR400



NCF Luminaire  
TR500



NCF Luminaire  
TR600



## Design Profile



IP65  
IK10  
UP to 160LM/W

## Prime Tri-proof

TR100

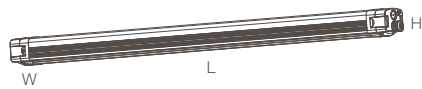

Prime tri-proof is a tool free multi connected fitting which with various of function options as be showed on this catalogue.

The excellent heating sink, function options and multi connecting make it has a wide range of used in different applications.

### Features

- > Quick snap end caps for easy installation
- > CCT & Wattage adjustable on end cap.
- > 5 wires 3 phase for more quantity linkable
- > 160LM/W high lumen efficacy
- > Single or linkable installation
- > 5 years warranty

### Data Sheet

Order Code	Rated Power	Lumen	LM/W	Flicker Free	Dimension (mm)	GW/CTN	QTY/CTN
TR100-02W-DN1-22F01-00	22W	typ.3500	typ.160	Y	L625 X W85 X H73	6.5kg	4pcs
TR100-04W-DN1-40F01-00	40W	typ.6400	typ.160	Y	L1200 X W85 X H73	9.5kg	4pcs
TR100-04W-DN1-60F01-00	60W	typ.9600	typ.160	Y	L1200 X W85 X H73	9.5kg	4pcs
TR100-05W-DN1-40F01-00	40W	typ.6400	typ.160	Y	L1500 X W85 X H73	12.5kg	4pcs
TR100-05W-DN1-60F01-00	60W	typ.9600	typ.160	Y	L1500 X W85 X H73	12.5kg	4pcs
TR100-08W-DN1-1BF01-00	100W	typ.16000	typ.160	Y	L2400 X W85 X H73	19.0kg	4pcs



**CCT** Single Color      Tri-color

**Function** ON OFF 3-Step Dimming DALI  
MS Light Sensor PIR Emergency

**Electrical Parameters**  
AC 200-240V PF ≥0.95 THD <15% Flicker Free

**Photometric Parameters**  
120 LM/W 140 LM/W 160 LM/W  
CRI>80 SDCM <5 LM79 TM-21 ERP2.0

**Wiring** Single wiring Double wiring 3wires 3Phase 5wires 3Phase 7wires 3Phase

**IP/IK** IP65 IK10

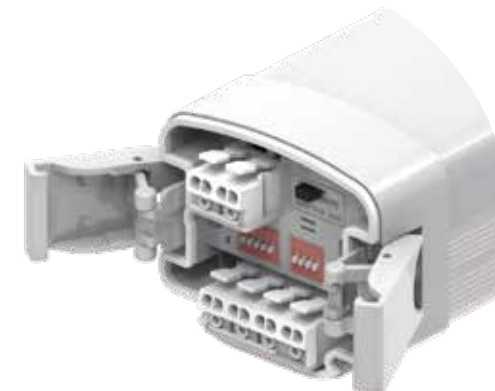

### Function options

- > CCT switch
- > Wattage switch
- > EM testing switch
- > MS switch
- > 3 phase switch
- > 3/5/7 wires terminal



# Design Profile

Dimmable Driver

Polycarbonate cover

LED PCB

Terminal for Quick Installation

Waterproof plug IP65

Aluminum Profile for heat dissipation

Grey Tray for easy replacement

## Deco Tri-proof

TR200



Deco tri-proof is new design which use the gear tray to realize the function options. The gear tray is taken put from the end cap.  
The excellent heating sink, function options and multi connecting make it has a wide range of used in different applications.

### Features

- > Quick snap end caps for easy installation
- > Easy for LED driver replacement
- > CCT & Wattage adjustable
- > 160LM/W with high lumen efficacy
- > Single or linkable installation
- > 5 years warranty



**CCT**

Single Color: 3000K, 4000K, 5000K, 6000K  
Tri-color: 2700K, 3000K, 3500K, 4000K

**Function**

ON/OFF, 1-10V Dimming, DALI, MS, Backlight Sensor, PIR, Emergency

**Electrical Parameters**

AC 200-240V, PF ≥0.95, THD <15%, Flicker Free

**Photometric Parameters**

120 LM/W, 140 LM/W, 160 LM/W  
CRI >80, SDCM <5, LM79 TM-21, ERP2.0

**Wiring**

Single wiring, Double wiring, 3wires 3Phase, 5wires 3Phase, 7wires 3Phase

**IP/IK**

IP65, IK10

### Data Sheet

Order Code	Rated Power	Lumen	LM/W	Flicker Free	Dimension (mm)	GW/CTN	QTY/CTN
TR200-02W-DN1-22F01-00	22W	typ.3500	typ.160	Y	L625 X W85 X H73	6.5kg	4pcs
TR200-04W-DN1-40F01-00	40W	typ.6400	typ.160	Y	L1200 X W85 X H73	9.5kg	4pcs
TR200-04W-DN1-60F01-00	60W	typ.9600	typ.160	Y	L1200 X W85 X H73	9.5kg	4pcs
TR200-05W-DN1-40F01-00	40W	typ.6400	typ.160	Y	L1500 X W85 X H73	12.5kg	4pcs
TR200-05W-DN1-60F01-00	60W	typ.9600	typ.160	Y	L1500 X W85 X H73	12.5kg	4pcs
TR200-08W-DN1-1BF01-00	100W	typ.16000	typ.160	Y	L2400 X W85 X H73	19.0kg	4pcs





# Design Profile

## Deco S Tri-proof TR600

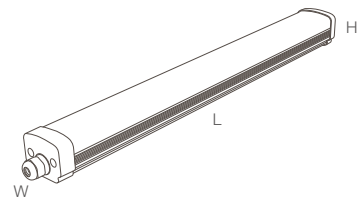

Deco S tri proof light with high lumen, waterproof IP65 and IK08, 140lm/w, a reliable and professional lighting solution. Perfect Balance between cost & performance !

### Features

- > Special design for back wiring
- > IP65 and IK08 for all industrial areas of application
- > Durable insulated power driver
- > Newest technology of SMD2835 LED
- > No UV or IR and completely mercury free
- > L80/B10 @ 50.000h
- > 5 years warranty

CCT Single Color **3000K** 4000K 5000K 6000K

Function

Electrical Parameters

AC 200-240V PF ≥0.95 THD <15% Flicker Free

Photometric Parameters

130 LM/W 150 LM/W  
CRI>80 SDCM <5 LM79 TM-21 ERP2.0

Wiring

Single wiring Double wiring 3wires 3Phase 5wires 3Phase

IP/IK

IP65 IK08

### Data Sheet

Order Code	Rated Power	Lumen	LM/W	Flicker Free	Dimension (mm)	GW/CTN	QTY/CTN
TP-TR600-02N-DT1-15F01-01	15W	typ.2250	typ.150	Y	L600 X W65 X H55	7.8kg	4pcs
TP-TR600-04N-DT1-34F01-01	20W	typ.3000	typ.150	Y	L1200 X W65 X H55	12.5kg	4pcs
TP-TR600-04N-DT1-20F01-01	34W	typ.5100	typ.150	Y	L1200 X W65 X H55	12.5kg	4pcs
TP-TR600-05N-DT1-28F01-01	28W	typ.4200	typ.150	Y	L1500 X W65 X H55	14.5kg	4pcs
TP-TR600-05N-DT1-56F01-01	56W	typ.8400	typ.150	Y	L1500 X W65 X H55	14.5kg	4pcs
TP-TR600-06N-DT1-32F01-01	32W	typ.4800	typ.150	Y	L1800 X W65 X H55	24.0kg	4pcs
TP-TR600-06N-DT1-65F01-01	65W	typ.9750	typ.150	Y	L1800 X W65 X H55	14.5kg	4pcs



Waterproof plug IP65



# Basic Tri-proof

## TR300

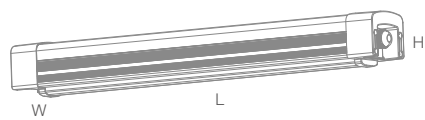

Basic Tri-proof light which were widely used on warehouses, factories, car parks, sports facilities etc. Outdoor, indoor commercial & industrial applications.

The Aluminum casing provides excellent heating dissipation, The high technology SMD2835 provide a more higher lumen output, up to 160lm/W.

### Features

- > IP65/IK10 approval
- > Single or multiple link
- > 5 years warranty

### Data Sheet

Order Code	Rated Power	Lumen	LM/W	Flicker Free	Dimension (mm)	GW/CTN	QTY/CTN
TR300-02W-DN1-22F01-00	22W	typ.3500	typ.160	Y	L625 X W85 X H78	7.8kg	4pcs
TR300-04W-DN1-40F01-00	40W	typ.6400	typ.160	Y	L1225 X W85 X H78	12.5kg	4pcs
TR300-04W-DN1-60F01-00	60W	typ.9600	typ.160	Y	L1225 X W85 X H78	12.5kg	4pcs
TR300-05W-DN1-40F01-00	40W	typ.6400	typ.160	Y	L1525 X W85 X H78	14.5kg	4pcs
TR300-05W-DN1-60F01-00	60W	typ.9600	typ.160	Y	L1525 X W85 X H78	14.5kg	4pcs
TR300-08W-DN1-1BF01-00	100W	typ.16000	typ.160	Y	L2425 X W85 X H78	24.0kg	4pcs

CCT Single Color **3000K** 4000K 5000K 6000K

Function

### Electrical Parameters

AC 200-240V PF ≥0.95 THD <15% Flicker Free

### Photometric Parameters

120 LM/W 140 LM/W 160 LM/W  
CRI>80 SDCM <5 LM79 TM-21 ERP2.0

### Wiring

Single wiring Double wiring 3wires 3Phase 5wires 3Phase

### IP/IK

IP65 IK10



# Tubar Lights

## TR400

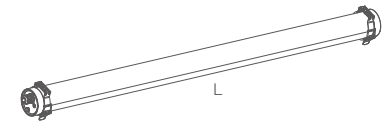

IP69K Tubar light an ideal solution for chemical cleaning, car washing, food processing and poultry lighting etc. industrial applications.

PMMA case for NH3-Anti Corrosion Resistance, PC Housing for UV Resistance. The high technology SMD2835 provide a more higher lumen output.

### Features

- > IP69K / IK10 Protection
- > Single or multiple link
- > 5 years warranty

### Data Sheet

Order Code	Rated Power	Lumen	LM/W	Flicker Free	Dimension (mm)	GW/CTN	QTY/CTN
TR400-02W-DN1-22F01-00	22W	typ.3050	typ.140	Y	L600 X D78	7.8kg	4pcs
TR400-04W-DN1-40F01-00	40W	typ.5500	typ.140	Y	L1200 X D78	12.5kg	4pcs
TR400-04W-DN1-60F01-00	60W	typ.8400	typ.140	Y	L1200 X D78	12.5kg	4pcs
TR400-05W-DN1-60F01-00	60W	typ.8400	typ.140	Y	L1500 X D78	14.5kg	4pcs

CCT Single Color **3000K** 4000K 5000K 6000K

Function

### Electrical Parameters

AC 200-240V PF ≥0.95 THD <15% Flicker Free

### Photometric Parameters

120 LM/W 140 LM/W CRI>80 SDCM <5 LM79 TM-21 ERP2.0

### Wiring

Single wiring Double wiring

### Material

PC PMMA

### IP/IK

IP69K IK10



# Single NCF

## TR500

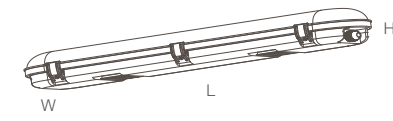

Single NCF fitting is a new design to replace the traditional fluorescent fitting. The different lengths are available .  
 Waterproof, Dust-proof , Corrosion-Proof, is the basic features of the luminaries. Exclusive Quick-fit design for faster installation.

- Features**
- > Easy Installation with fast connection design
  - > End or rear cable entry
  - > IP 65 Rating, High impact IK08
  - > Single installation or linkable
  - > 5 years warranty

**CCT** Single Color 3000K, 4000K, 5000K, 6000K Tri-color 2700K, 3000K, 3500K, 4000K, 4500K, 5000K, 5500K, 6000K

**Function** ON/OFF, 1-10V Dimming, DALI, MS, Emergency

**Electrical Parameters** AC 200-240V, PF ≈0.95, THD <15%, Flicker Free

**Photometric Parameters** 120 LM/W, 140 LM/W, CRI>80 SDCM <5, LM79 TM-21, ERP2.0

**Wiring** Single wiring, Double wiring

**IP/IK** IP65, IK08

### Data Sheet

Order Code	Rated Power	Lumen	LM/W	Flicker Free	Dimension (mm)	GW/CTN	QTY/CTN
TR500-02W-DN1-20F01-00	20W	typ.2800	typ.140	Y	L600 X W80 X H75	6.2kg	6pcs
TR500-04W-DN1-30F01-00	30W	typ.4200	typ.140	Y	L1200 X W80 X H75	11.2kg	6pcs
TR500-05W-DN1-25F01-00	25W	typ.3500	typ.140	Y	L1500 X W80 X H75	14.2kg	6pcs
TR500-05W-DN1-50F01-00	50W	typ.7000	typ.140	Y	L1500 X W80 X H75	14.2kg	6pcs
TR500-06W-DN1-30F01-00	30W	typ.4200	typ.140	Y	L1800 X W80 X H75	17.5kg	6pcs
TR500-06W-DN1-50F01-00	50W	typ.7000	typ.140	Y	L1800 X W80 X H75	17.5kg	6pcs



# Twins NCF

TR510

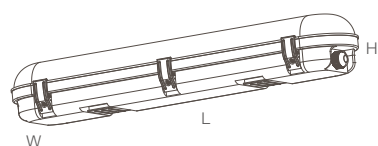

Twins NCF fitting is a new design to replace the traditional fluorescent fitting. The different lengths are available .  
Waterproof, Dust-proof , Corrosion-Proof, is the basic features of the luminaires. Exclusive Quick-fit design for faster installation.

## Features

- > Easy Installation with fast connection design
- > End or rear cable entry
- > IP 65 Rating, High impact IK08
- > Single installation or linkable
- > 5 years warranty

## CCT

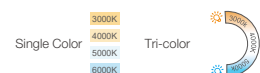

## Function



## Electrical Parameters



## Photometric Parameters



## Wiring



## IP/IK

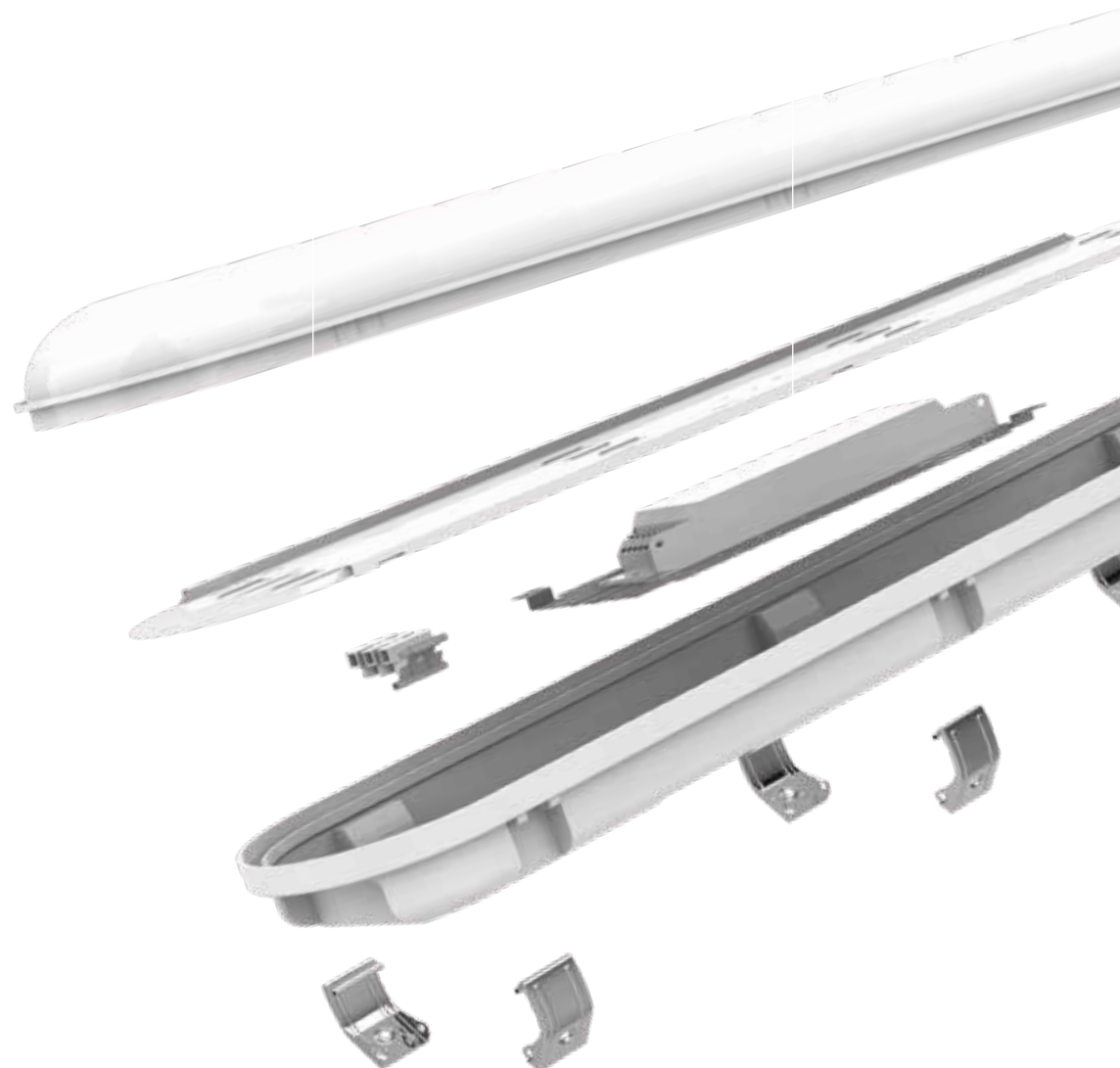

Polycarbonate base

Stainless steel assembly clips

## Data Sheet

Order Code	Rated Power	Lumen	LM/W	Flicker Free	Dimension (mm)	GW/CTN	QTY/CTN
TR510-02W-DN1-22F01-00	20W	typ.2800	typ.140	Y	L600 X W125 X H88	8.64kg	6pcs
TR510-04W-DN1-40F01-00	40W	typ.5600	typ.140	Y	L1200 X W125 X H88	16.0kg	6pcs
TR510-05W-DN1-50F01-00	50W	typ.7000	typ.140	Y	L1500 X W125 X H88	20.4kg	6pcs
TR510-06W-DN1-50F01-00	50W	typ.7000	typ.140	Y	L1800 X W125 X H88	25.5kg	6pcs
TR510-06W-DN1-75F01-00	75W	typ.10500	typ.140	Y	L1800 X W125 X H88	25.5kg	6pcs





# MOD 320 BH100

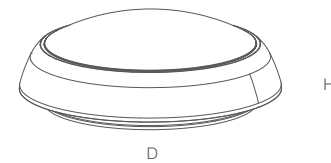

MOD -D320 bulkheads widely use to replace the traditional 2D fluorescent light, The suitable dimension and various of function options make it very popular on the market. It can reach 120 LM/W and 150 LM/W to help you get a well energy saving.

### Features

- > Up to 150 LM/W@ 2400LM
- > IP65 waterproof
- > UV -Anti
- > Various of function options
- > Various of bezels are available
- > Warranty: 5 years

**CCT**

Single Color: 3000K, 4000K, 5000K, 6000K  
Tri-color: 2700K, 3000K, 3500K, 4000K, 4500K, 5000K, 5500K, 6000K

**Function**

F1: ON/OFF  
F2: ON/OFF + Emergency  
F3: ON/OFF + MS  
F4: ON/OFF + Emergency + MS  
F5: ON/OFF + Self EM  
F6: ON/OFF + Self EM + MS

**Electrical Parameters**

AC 200-240V, PF ≥0.95, THD <15%, Flicker Free

**Photometric Parameters**

120 LM/W, 150 LM/W, CRI>80 SDCM <5, LM79 TM-21, ERP2.0

**IP Rating**

IP65

**Finish**

White, Silver, Black

### Data Sheet

Order Code	Rated Power	Lumen	LM/W	Function	Flicker Free	Dimension (mm)	GW/CTN	QTY/CTN
BH100-32W-DN1-12F01-00	12W	typ.1800	typ.150	F1-F6	Y	D325 X H113	13.0kg	10pcs
BH100-32W-DN1-16F01-00	16W	typ.2400	typ.150	F1-F6	Y	D325 X H113	14.0kg	10pcs

# Design Profile





# MOD 270 BH120

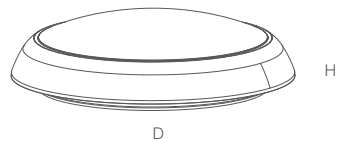

MOD -D270 bulkheads widely use to replace the traditional 2D fluorescent light, The suitable dimension and various of function options make it very popular on the market. It can reach 120 LM/W to help you get a well energy saving.

### Features

- > Up to 120 LM/W @1450LM
- > IP65 waterproof
- > UV-Anti
- > Various of function options
- > Warranty: 5 years

**CCT** Single Color 3000K, 4000K, 5000K, 6000K Tri-color 3000K, 4000K, 5000K

**Function**  
 F1: ON/OFF  
 F2: ON/OFF + Emergency  
 F3: ON/OFF + MS  
 F4: ON/OFF + Emergency + MS  
 F5: ON/OFF + Self EM  
 F6: ON/OFF + Self EM + MS

**Electrical Parameters**  
 AC 200-240V, PF ≥0.95, THD <15%, Flicker Free

**Photometric Parameters**  
 100 LM/W, 120 LM/W, CRI>80 SDCM <5, LM79 TM-21, ERP2.0

**IP Rating** IP65

**Finish** White, Silver, Black

### Data Sheet

Order Code	Rated Power	Lumen	LM/W	Function	Flicker Free	Dimension (mm)	GW/CTN	QTY/CTN
BH120-27W-KN1-10F01-00	10W	typ.1200	typ.120	F1-F6	Y	D270 X H113	11.0kg	10pcs
BH120-27W-KN1-12F01-00	12W	typ.1450	typ.120	F1-F6	Y	D270 X H113	11.0kg	10pcs



# MOD 470 BH130

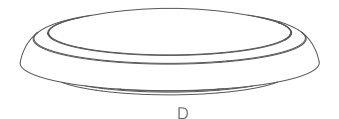

MOD -D470 bulkheads widely use to replace the traditional 2D fluorescent light, The suitable dimension and various of function options make it very popular on the market. It can reach 120 LM/W and 150 LM/W to help you get a well energy saving.

### Features

- > Up to 150 LM/W@4500LM
- > IP65 waterproof
- > UV-Anti
- > Various of function options
- > Warranty: 5 years

**CCT** Single Color 3000K, 4000K, 5000K, 6000K Tri-color 3000K, 4000K, 5000K

**Function**  
 F1: ON/OFF  
 F2: ON/OFF + Emergency  
 F3: ON/OFF + MS  
 F4: ON/OFF + Emergency + MS  
 F5: ON/OFF + Self EM  
 F6: ON/OFF + Self EM + MS

**Electrical Parameters**  
 AC 200-240V, PF ≥0.95, THD <15%, Flicker Free

**Photometric Parameters**  
 120 LM/W, 150 LM/W, CRI>80 SDCM <5, LM79 TM-21, ERP2.0

**IP Rating** IP65

**Finish** White, Silver, Black

### Data Sheet

Order Code	Rated Power	Lumen	LM/W	Function	Flicker Free	Dimension (mm)	GW/CTN	QTY/CTN
BH130-47W-DN1-20F01-00	20W	typ.3000	typ.150	F1-F6	Y	D470 X H93	10.0kg	5pcs
BH130-47W-DN1-30F01-00	30W	typ.4500	typ.150	F1-F6	Y	D470 X H93	10.0kg	5pcs



# Gamma

## BH200 | D295

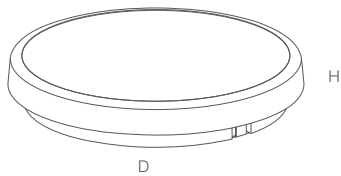

Gamma is a smart design and functional bulkhead. Use the bracket for the surface mounting installation, AC terminal and functional switch in the case make the gamma very popular.

### Features

- > Up to 130 LM/W@ 2100 LM
- > IP65 waterproof
- > UV-Anti
- > Various of function options
- > Warranty: 5 years

**CCT**

Single Color: 3000K, 4000K, 5000K, 6000K

Tri-color: 2700K, 3000K, 3500K, 4000K, 4500K, 5000K, 5500K, 6000K

**Function**

F1: ON/OFF

F2: ON/OFF + Emergency

F3: ON/OFF + MS

F4: ON/OFF + Emergency + MS

F5: ON/OFF + Self EM

F6: ON/OFF + Self EM + MS

**Electrical Parameters**

AC 200-240V

PF ≥0.95

THD <15%

Flicker Free

**Photometric Parameters**

100 LM/W

130 LM/W

CRi>80 SDCM <5

LM79 TM-21

ERP2.0

**IP Rating**

IP65

**Finish**

White Silver Black

### Data Sheet

Order Code	Rated Power	Lumen	LM/W	Function	Flicker Free	Dimension (mm)	GW/CTN	QTY/CTN
BH200-29W-ST1-12F01-00	12W	typ.1600	typ.130	F1-F6	Y	D295 X H57	12.6kg	10pcs
BH200-29W-ST1-16F01-00	16W	typ.2100	typ.130	F1-F6	Y	D295 X H57	12.6kg	10pcs



# Gamma Mini

## BH210 | D250

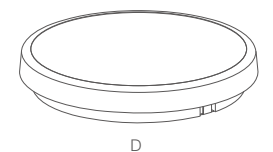

Gamma Mini is a smart design and functional bulkhead. Use the bracket for the surface mounting installation, AC terminal and functional switch in the case make the gamma mini very popular.

### Features

- > Up to 120 LM/W@ 1200 LM
- > IP65 waterproof
- > UV-Anti
- > Various of function options
- > Warranty: 5 years

**CCT**

Single Color: 3000K, 4000K, 5000K, 6000K

Tri-color: 2700K, 3000K, 3500K, 4000K, 4500K, 5000K, 5500K, 6000K

**Function**

F1: ON/OFF

F2: ON/OFF + Emergency

F3: ON/OFF + MS

F4: ON/OFF + Emergency + MS

F5: ON/OFF + Self EM

F6: ON/OFF + Self EM + MS

**Electrical Parameters**

AC 200-240V

PF ≥0.95

THD <15%

Flicker Free

**Photometric Parameters**

100 LM/W

120 LM/W

CRi>80 SDCM <5

LM79 TM-21

ERP2.0

**IP Rating**

IP65

**Finish**

White Silver Black

### Data Sheet

Order Code	Rated Power	Lumen	LM/W	Function	Flicker Free	Dimension (mm)	GW/CTN	QTY/CTN
BH210-25W-ST1-10F01-00	10W	typ.1200	Typ.120	F1-F6	Y	D250 X H50	12.5kg	10pcs





## Pro R280 BH300

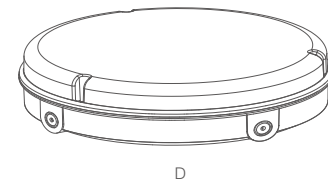

Pro is a 4 knock-out bulkhead, It is a IP65 and UV-Anti full with full plastic case.  
The multiple function options make the Pro same as the other bulkhead which is widely used on the indoor and outdoor applications.  
High technology LED makes the more higher lumem output

### Features

- > Up to 150 LM/W@ 2400 LM
- > IP65 waterproof
- > UV-Anti
- > Various of function options
- > Warranty: 5 years

**CCT**

Single Color: 3000K, 4000K, 5000K, 6000K  
Tri-color: 2700K, 3000K, 3500K, 4000K, 4500K, 5000K, 5500K, 6000K

**Function**

F1: ON/OFF  
F2: ON/OFF + Emergency  
F3: ON/OFF + MS  
F4: ON/OFF + Emergency + MS  
F5: ON/OFF + Self EM  
F6: ON/OFF + Self EM + MS

**Electrical Parameters**

AC 200-240V, PF ≥0.95, THD <15%, Flicker Free

**Photometric Parameters**

120 LM/W, 150 LM/W, CR<sub>B</sub>-80 SDCM <sub>5</sub>, LM79 TM-21, ERP2.0

**IP Rating**

IP65

**Finish**

White, Silver, Black

### Data Sheet

Order Code	Rated Power	Lumen	LM/W	Function	Flicker Free	Dimension (mm)	GW/CTN	QTY/CTN
BH300-28W-ST1-12F01-00	12W	typ.1800	Typ.150	F1-F6	Y	D280 X H85	12.0kg	10pcs
BH300-28W-ST1-16F01-00	16W	typ.2400	Typ.150	F1-F6	Y	D280 X H85	12.0kg	10pcs



## Pro R320 BH320

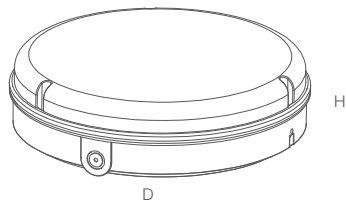

Pro Series bulkheads be designed a function gear tray which be assembled together with PC cover as a assembly unit

The simple design makes our lamp very easy on the installation.

### Features

- > Up to 130 LM/W@ 2600LM
- > IP65 waterproof
- > UV-Anti
- > Various of function options
- > Warranty: 5 years

### Data Sheet

Order Code	Rated Power	Lumen	LM/W	Function	Flicker Free	Dimension (mm)	GW/CTN	QTY/CTN
BH320-32W-AT1-20F01-00	20W	typ.2600	typ.130	F1-F6	Y	D320 X H85	11.0kg	5pcs



## Pro R320A BH321

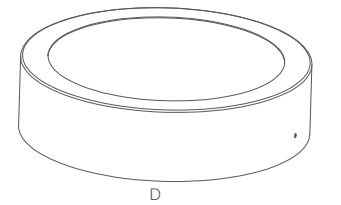

Pro Series bulkheads be designed a function gear tray which be assembled together with PC cover as a assembly unit

The simple design makes our lamp very easy on the installation.

### Features

- > Up to 130 LM/W@ 2600LM
- > IP65 waterproof
- > UV-Anti
- > Various of function options
- > Warranty: 5 years

### Data Sheet

Order Code	Rated Power	Lumen	LM/W	Function	Flicker Free	Dimension (mm)	GW/CTN	QTY/CTN
BH321-32W-AT1-20F01-00	20W	typ.2600	typ.130	F1-F6	Y	D320 X H85	13kg	5pcs

CCT: Single Color (3000K, 4000K, 5000K, 6000K), Tri-color (2700K, 3000K, 3500K, 4000K, 4500K, 5000K)

Function:

- F1: ON/OFF
- F2: ON/OFF + Emergency
- F3: ON/OFF + MS
- F4: ON/OFF + Emergency + MS
- F5: ON/OFF + Self EM
- F6: ON/OFF + Self EM + MS

### Electrical Parameters

AC 200-240V	PF ≥0.95	THD <15%	Flicker Free
-------------	----------	----------	--------------

### Photometric Parameters

100 LM/W	130 LM/W	CRI>80 SDCM <5	LM79 TM-21	ERP2.0
----------	----------	----------------	------------	--------

### IP Rating

IP65
------

### Finish



CCT: Single Color (3000K, 4000K, 5000K, 6000K), Tri-color (2700K, 3000K, 3500K, 4000K, 4500K, 5000K)

Function:

- F1: ON/OFF
- F2: ON/OFF + Emergency
- F3: ON/OFF + MS
- F4: ON/OFF + Emergency + MS
- F5: ON/OFF + Self EM
- F6: ON/OFF + Self EM + MS

### Electrical Parameters

AC 200-240V	PF ≥0.95	THD <15%	Flicker Free
-------------	----------	----------	--------------

### Photometric Parameters

130 LM/W	CRI>80 SDCM <5	LM79 TM-21	ERP2.0
----------	----------------	------------	--------

### IP Rating

IP65
------

### Finish

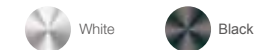



# Pro S320 BH330

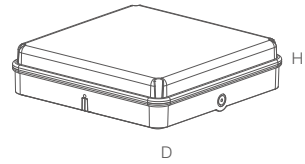

Pro Series bulkheads be designed a function gear tray which be assembled together with PC cover as a assembly unit

The simple design makes our lamp very easy on the installation.

## Features

- > Up to 130 LM/W@ 2600LM
- > IP65 waterproof
- > UV-Anti
- > Various of function options
- > Warranty: 5 years

## Data Sheet

Order Code	Rated Power	Lumen	LM/W	Function	Flicker Free	Dimension (mm)	GW/CTN	QTY/CTN
BH330-32W-AT1-20F01-00	20W	typ.2600	typ.130	F1-F6	Y	D320 X H85	11.0kg	5pcs



# Pro S320A BH331

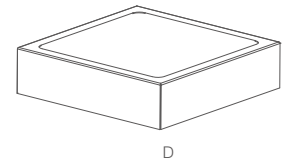

Pro Series bulkheads be designed a function gear tray which be assembled together with PC cover as a assembly unit

The simple design makes our lamp very easy on the installation.

## Features

- > Up to 130 LM/W@ 2600LM
- > IP65 waterproof
- > UV-Anti
- > Various of function options
- > Warranty: 5 years

## Data Sheet

Order Code	Rated Power	Lumen	LM/W	Function	Flicker Free	Dimension (mm)	GW/CTN	QTY/CTN
BH331-20W-AT1-20F01-00	20W	typ.2600	typ.130	F1-F6	Y	D320 X H85	13kg	5pcs

CCT: Single Color (3000K, 4000K, 5000K, 6000K), Tri-color (2700K, 3000K, 3500K, 4000K, 4500K, 5000K, 5500K, 6000K)

Function:

- F1: ON/OFF
- F2: ON/OFF + Emergency
- F3: ON/OFF + MS
- F4: ON/OFF + Emergency + MS
- F5: ON/OFF + Self EM
- F6: ON/OFF + Self EM + MS

Electrical Parameters:

- AC 200-240V
- PF ≥0.95
- THD <15%
- Flicker Free

Photometric Parameters:

- 100 LM/W
- 130 LM/W
- CRI>80 SDCM <5
- LM79 TM-21
- ERP2.0

IP Rating: IP65

Finish: White, Black

CCT: Single Color (3000K, 4000K, 5000K, 6000K), Tri-color (2700K, 3000K, 3500K, 4000K, 4500K, 5000K, 5500K, 6000K)

Function:

- F1: ON/OFF
- F2: ON/OFF + Emergency
- F3: ON/OFF + MS
- F4: ON/OFF + Emergency + MS
- F5: ON/OFF + Self EM
- F6: ON/OFF + Self EM + MS

Electrical Parameters:

- AC 200-240V
- PF ≥0.95
- THD <15%
- Flicker Free

Photometric Parameters:

- 130 LM/W
- CRI>80 SDCM <5
- LM79 TM-21
- ERP2.0

IP Rating: IP65

Finish: White, Black



BH420



BH421

## Lunar D350

BH420 | Die-cast

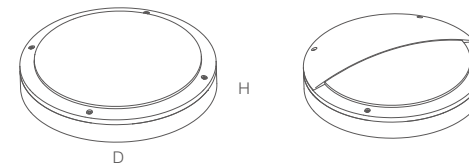

Lunar is die-cast bulkhead with full and half moon cover, It is widely used at outdoor applications due to the IP65 / UV-anti / Aluminum case as heating sink.  
 Easy quick installation - wall or ceiling mounted.  
 High technology LED provide a more higher lumen output.

### Features

- > UP to 150LM/W@4500LM
- > Die-cast Aluminum case as heating sink
- > IP65 waterproof & UV-Anti
- > 5 years warranty

**CCT**

Single Color: 3000K, 4000K, 5000K, 6000K  
 Tri-color: 3000K, 4000K, 5000K

**Function**

F1: ON/OFF  
 F2: ON/OFF + Emergency  
 F3: ON/OFF + MS  
 F4: ON/OFF + Emergency + MS  
 F5: ON/OFF + Self EM  
 F6: ON/OFF + Self EM + MS

**Electrical Parameters**

AC 200-240V, PF ≥0.95, THD <15%, Flicker Free

**Photometric Parameters**

120 LM/W, 150 LM/W, CRI>80 SDCM <5, LM79 TM-21, ERP2.0

**IP Rating**

IP65

**Finish**

White, Gray, Black

### Data Sheet

Order Code	Rated Power	Lumen	LM/W	Function	Flicker Free	Dimension (mm)	GW/CTN	QTY/CTN
BH420-35W-DT1-20F01-00	20W	typ.3000	typ.150	F1-F6	Y	D350 X H107	12.0kg	4pcs
BH420-35W-DT1-30F01-00	30W	typ.4500	typ.150	F1-F6	Y	D350 X H107	12.0kg	4pcs





BH410



BH411



BH400



BH401

## Lunar D275 BH410 | Die-cast

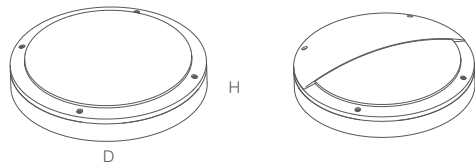

Lunar is die-cast bulkhead with full and half moon cover,  
It is widely used at outdoor applications due to the IP65 /  
UV-anti / Aluminum case as heating sink.  
Easy quick installation - wall or ceiling mounted.  
High technology LED provide a more higher lumen output.

### Features

- > UP to 130LM/W@2100LM
- > Die-cast Aluminum case as heating sink
- > IP65 waterproof & UV-Anti
- > 5 years warranty

CCT: Single Color (3000K, 4000K, 5000K, 6000K), Tri-color (2700K, 3000K, 3500K, 4000K)

Function: F1: ON/OFF; F2: ON/OFF + Emergency; F3: ON/OFF + MS; F4: ON/OFF + Emergency + MS; F5: ON/OFF + Self Off; F6: ON/OFF + Self EM + MS

Electrical Parameters: AC 200-240V, PF ≥0.95, THD <15%, Flicker Free

Photometric Parameters: 100 LM/W, 130 LM/W, CRI>80 SDCM <5, LM79 TM-21, ERP2.0

IP Rating: IP65

Finish: White, Gray, Black

### Data Sheet

Order Code	Rated Power	Lumen	LM/W	Function	Flicker Free	Dimension (mm)	GW/CTN	QTY/CTN
BH410-27W-DT1-12F01-00	12W	typ.1500	typ.130	F1-F6	Y	D275 X H80	11.0kg	5pcs
BH410-27W-DT1-16F01-00	16W	typ.2100	typ.130	F1-F6	Y	D275 X H80	11.0kg	5pcs

## Lunar D220 BH400 | Die-cast

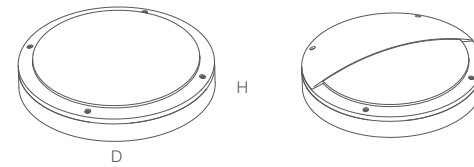

Lunar is die-cast bulkhead with full and half moon cover,  
It is widely used at outdoor applications due to the IP65 /  
UV-anti / Aluminum case as heating sink.  
Easy quick installation - wall or ceiling mounted.  
High technology LED provide a more higher lumen output.

### Features

- > UP to 100LM/W@1000LM
- > Die-cast Aluminum case as heating sink
- > IP65 waterproof & UV-Anti
- > 5 years warranty

### Data Sheet

Order Code	Rated Power	Lumen	LM/W	Function	Flicker Free	Dimension (mm)	GW/CTN	QTY/CTN
BH400-22W-DT1-10F01-00	10W	typ.1000	typ.100	F1-F6	Y	D222 X H66	11.0kg	10pcs

CCT: Single Color (3000K, 4000K, 5000K, 6000K), Tri-color (2700K, 3000K, 3500K, 4000K)

Function: F1: ON/OFF; F2: ON/OFF + Emergency; F3: ON/OFF + MS; F4: ON/OFF + Emergency + MS; F5: ON/OFF + Self Off; F6: ON/OFF + Self EM + MS

Electrical Parameters: AC 200-240V, PF ≥0.95, THD <15%, Flicker Free

Photometric Parameters: 100 LM/W, CRI>80 SDCM <5, LM79 TM-21, ERP2.0

IP Rating: IP65

Finish: White, Gray, Black



PC cover + gear tray assembly  
with functional module

- Standard ON/OFF
- Standard+ 3h Emergency
- Standard+ Microwave
- Standard+ 3h Emergency + Microwave



installation bottom plastic case

LiFePO4 -IRON BATTERIES -3 hours  
Emergency Operation

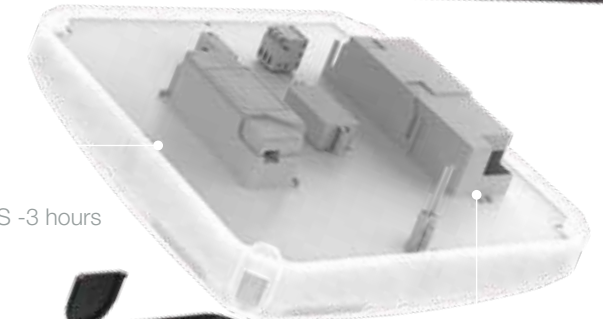

Waterproof gasket



1-10v Dimming/DALI Driver

Plastic outer ring

The plastic outer ring provide the white  
and black color with 4 knock-out clips



# Astro

## BH500 | S260

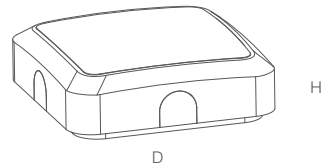

Astro series bulkheads be designed a function gear tray which be assembled together with PC cover as a assembly unit

The 4 knock-out clips on the middle rings makes the Astro very easy on the installation

### Features

- > Up to 130 LM/W@ 2600LM
- > IP65 waterproof
- > UV-Anti
- > Various of function options
- > Warranty: 5 years

### Data Sheet

Order Code	Rated Power	Lumen	LM/W	Function	Flicker Free	Dimension (mm)	GW/CTN	QTY/CTN
BH500-26W-AT1-14F10-00	7-14W	typ.900-1800	typ.130	F1-F6	Y	D263 X H74	11.0kg	5pcs



# Astro Mini

## BH510 | S200

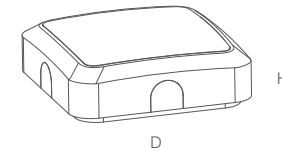

Astro series bulkheads be designed a function gear tray which be assembled together with PC cover as a assembly unit

The 4 knock-out clips on the middle rings makes the Astro very easy on the installation

### Features

- > Up to 120 LM/W@ 1680LM
- > IP65 waterproof
- > UV-Anti
- > Various of function options
- > Warranty: 5 years

### Data Sheet

Order Code	Rated Power	Lumen	LM/W	Function	Flicker Free	Dimension (mm)	GW/CTN	QTY/CTN
BH510-20W-AT1-07F10-00	3.5-7W	typ.420-840	typ.120	F1-F6	Y	D200 X H65	9.7kg	5pcs

CCT

Single Color: 3000K, 4000K, 5000K, 6000K

Tri-color: 2700K, 3000K, 3500K, 4000K, 4500K, 5000K, 5500K, 6000K

Function

F1: ON/OFF

F2: ON/OFF + Emergency

F3: ON/OFF + MS

F4: ON/OFF + Emergency + MS

F5: ON/OFF + Self EM

F6: ON/OFF + Self EM + MS

Electrical Parameters

AC 200-240V

PF ≥0.95

THD <15%

Flicker Free

Photometric Parameters

100 LM/W

130 LM/W

CRi>80 SDCM <5

LM79 TM-21

ERP2.0

IP Rating

IP65

Finish

White

Black

CCT

Single Color: 3000K, 4000K, 5000K, 6000K

Tri-color: 2700K, 3000K, 3500K, 4000K, 4500K, 5000K, 5500K, 6000K

Function

F1: ON/OFF

F2: ON/OFF + Emergency

F3: ON/OFF + MS

F4: ON/OFF + Emergency + MS

F5: ON/OFF + Self EM

F6: ON/OFF + Self EM + MS

Electrical Parameters

AC 200-240V

PF ≥0.95

THD <15%

Flicker Free

Photometric Parameters

100 LM/W

CRi>80 SDCM <5

LM79 TM-21

ERP2.0

IP Rating

IP65

Finish

White

Black



## Delta BH520 | R290

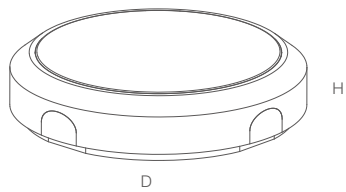

Delta series bulkheads be designed a function gear tray which be assembled together with PC cover as a assembly unit

The 4 knock-out clips on the middle rings makes the Astro very easy on the installation

### Features

- > Up to 130 LM/W@ 2600LM
- > IP65 waterproof
- > UV-Anti
- > Various of function options
- > Warranty: 5 years

### Data Sheet

Order Code	Rated Power	Lumen	LM/W	Function	Flicker Free	Dimension (mm)	GW/CTN	QTY/CTN
BH520-29W-AT1-14F10-00	7-14W	typ.900-1800	typ.130	F1-F6	Y	D290 X H74	11.0kg	5pcs



## Delta Mini BH530 | R200

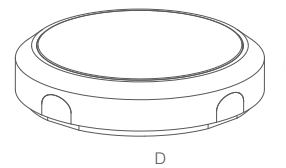

Delta series bulkheads be designed a function gear tray which be assembled together with PC cover as a assembly unit

The 4 knock-out clips on the middle rings makes the Astro very easy on the installation

### Features

- > Up to 120 LM/W@ 1680LM
- > IP65 waterproof
- > UV-Anti
- > Various of function options
- > Warranty: 5 years

### Data Sheet

Order Code	Rated Power	Lumen	LM/W	Function	Flicker Free	Dimension (mm)	GW/CTN	QTY/CTN
BH530-20W-AT1-07F10-00	3.5-7W	typ.420-840	typ.120	F1-F6	Y	D200 X H65	9.7kg	5pcs

CCT

Single Color: 3000K, 4000K, 5000K, 6000K

Tri-color: 2700K, 3000K, 3500K, 4000K, 4500K, 5000K, 5500K, 6000K

Function

F1: ON/OFF

F2: ON/OFF + Emergency

F3: ON/OFF + MS

F4: ON/OFF + Emergency + MS

F5: ON/OFF + Self EM

F6: ON/OFF + Self EM + MS

Electrical Parameters

AC 200-240V

PF ≥0.95

THD <15%

Flicker Free

Photometric Parameters

100 LM/W

130 LM/W

CRI>80 SDCM <5

LM79 TM-21

ERP2.0

IP Rating

IP65

Finish

White

Black

CCT

Single Color: 3000K, 4000K, 5000K, 6000K

Tri-color: 2700K, 3000K, 3500K, 4000K, 4500K, 5000K, 5500K, 6000K

Function

F1: ON/OFF

F2: ON/OFF + Emergency

F3: ON/OFF + MS

F4: ON/OFF + Emergency + MS

F5: ON/OFF + Self EM

F6: ON/OFF + Self EM + MS

Electrical Parameters

AC 200-240V

PF ≥0.95

THD <15%

Flicker Free

Photometric Parameters

100 LM/W

CRI>80 SDCM <5

LM79 TM-21

ERP2.0

IP Rating

IP65

Finish

White

Black





## Wall Pack WP100

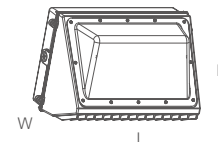

The LED Wall Pack Light is great for commercial and security lighting purposes where the light will need to operate for long periods of time. Their bright light output and adjustable mount design make them an ideal choice for illuminating building perimeters where control of spill light is important.

### Features

- > Various of functions for options
- > High lumen output at 130LM/W
- > Surge protection: L/N-PE: 5kV, L-N: 5kV
- > Easy Installation
- > Flicker free
- > 5 years warranty

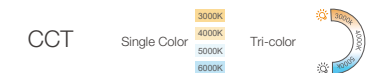

### Electrical Parameters



### Photometric Parameters



### IP/IK



### Data Sheet

Order Code	Rated Power	Lumen	LM/W	Flicker Free	Dimension (mm)	GW/CTN	QTY/CTN
WP100-36B-AN1-50F01-00	50W	typ.6500	typ.130	Y	L363 X W235 X H196	2.8kg	1pcs
WP100-36B-AN1-75F01-00	75W	typ.9750	typ.130	Y	L363 X W235 X H196	3.4kg	1pcs
WP100-36B-AN1-1BF01-00	100W	typ.13000	typ.130	Y	L363 X W235 X H196	3.7kg	1pcs



# Wall Pack

## WP200

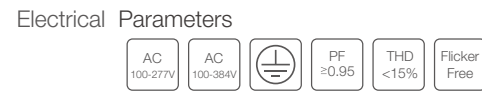
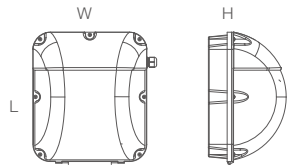

The LED Wall Pack Light is great for commercial and security lighting purposes where the light will need to operate for long periods of time. Their bright light output and adjustable mount design make them an ideal choice for illuminating building perimeters where control of spill light is important.

### Features

- > Various of functions for options
- > High lumen output at 130LM/W
- > Surge protection: L/N-PE: 5kV, L-N: 5kV
- > Easy Installation
- > Flicker free
- > 5 years warranty

### Data Sheet

Order Code	Rated Power	Lumen	LM/W	Flicker Free	Dimension (mm)	GW/CTN	QTY/CTN
WP200-30B-AN1-40F01-00	40W	typ.5200	typ.130	Y	L308 X W265 X H182	2.8kg	1pcs







# Vasco R350A

## CL100

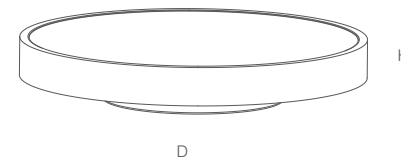

Vasco series is a low glare/UGR<19 and IP20 ceiling light the classic round shape is simple and elegant, the low-glare lighting design makes it suitable for a variety of indoor applications  
 120LM/W and UGR<19 features make the more and more client interest in the vasco ceiling light

### Features

- > Up to 120 LM/W@ 3600LM
- > Aluminum round shape + Prismatic diffuser UGR<19
- > Junction box for easy installation
- > Various of function options
- > Warranty: 5 years

**CCT**

Single Color: 3000K, 4000K, 5000K, 6000K  
 Tri-color: 3000K, 4000K, 5000K

**Function**

F1: ON/OFF  
 F2: ON/OFF + Emergency  
 F3: ON/OFF + MS  
 F4: ON/OFF + Emergency + MS  
 F5: ON/OFF + Self EM  
 F6: ON/OFF + Self EM + MS

**Electrical Parameters**

AC 200-240V, PF ≥0.95, THD <15%, Flicker Free

**Photometric Parameters**

100 LM/W, 120 LM/W, CRI>80 SDCM <5, LM79 TM-21, ERP2.0

**IP Rating**

IP20

**Finish**

White, Black

### Data Sheet

Order Code	Rated Power	Lumen	LM/W	Flicker Free	UP Light	Dimension (mm)	GW/CTN	QTY/CTN
CL100-35W-KT1-20F01-00	20W	typ.2400	typ.120	Y	N	D350xH80	14kg	5pcs
CL101-35W-KT1-20F01-00	20W	typ.2400	typ.120	Y	Y	D350xH80	14kg	5pcs



# Vasco R450A

## CL110

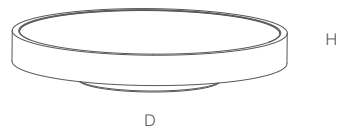

Vasco series is a low glare/UGR<19 and IP20 ceiling light the classic round shape is simple and elegant, the low-glare lighting design makes it suitable for a variety of indoor applications  
120LM/W and UGR<19 features make the more and more client interest in the vasco ceiling light

### Features

- > Up to 120 LM/W@ 3600LM
- > Aluminum round shape + Prismatic diffuser UGR<19
- > Junction box for easy installation
- > Various of function options
- > Warranty: 5 years

### Data Sheet

Order Code	Rated Power	Lumen	LM/W	Flicker Free	UP Light	Dimension (mm)	GW/CTN	QTY/CTN
CL110-45W-KT1-30F01-00	30W	typ.3600	typ.120	Y	N	D450xH80	17kg	5pcs
CL111-45W-KT1-30F01-00	30W	typ.3600	typ.120	Y	Y	D450xH80	17kg	5pcs

### CCT

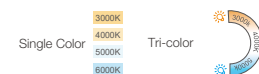

### Function



### Electrical Parameters



### Photometric Parameters



### IP Rating



### Finish



# Vasco R600A

## CL120

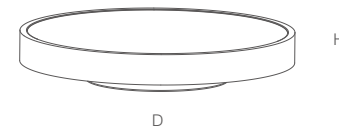

Vasco series is a low glare/UGR<19 and IP20 ceiling light the classic round shape is simple and elegant, the low-glare lighting design makes it suitable for a variety of indoor applications  
120LM/W and UGR<19 features make the more and more client interest in the vasco ceiling light

### Features

- > Up to 120 LM/W@ 6000LM
- > Aluminum round shape + Prismatic diffuser UGR<19
- > Junction box for easy installation
- > Various of function options
- > Warranty: 5 years

### Data Sheet

Order Code	Rated Power	Lumen	LM/W	Flicker Free	UP Light	Dimension (mm)	GW/CTN	QTY/CTN
CL120-60W-KT1-50F01-00	50W	typ.6000	typ.120	Y	N	D600xH90	5.8kg	1pcs
CL121-60W-KT1-50F01-00	50W	typ.6000	typ.120	Y	Y	D600xH90	5.8kg	1pcs

### CCT

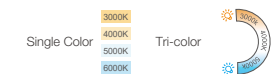

### Function

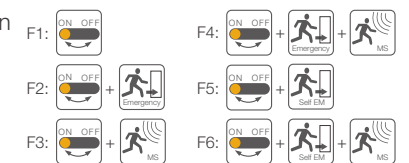

### Electrical Parameters



### Photometric Parameters



### IP Rating



### Finish







# Vasco R900A

## CL130

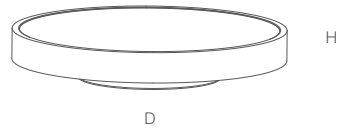

Vasco series is a low glare/UGR<19 and IP20 ceiling light the classic round shape is simple and elegant, the low-glare lighting design makes it suitable for a variety of indoor applications  
120LM/W and UGR<19 features make the more and more client interest in the vasco ceiling light

### Features

- > Up to 120 LM/W@ 8160LM
- > Aluminum round shape + Prismatic diffuser UGR<19
- > Junction box for easy installation
- > Various of function options
- > Warranty: 5 years

### Data Sheet

Order Code	Rated Power	Lumen	LM/W	Flicker Free	UP Light	Dimension (mm)	GW/CTN	QTY/CTN
CL130-90W-KT1-68F01-00	68W	typ.8160	typ.120	Y	N	D900xH90	7kg	1pcs
CL131-90W-KT1-68F01-00	68W	typ.8160	typ.120	Y	Y	D900xH90	7kg	1pcs

**CCT** Single Color  3000K  4000K  5000K  6000K **Tri-color**  3000K  4000K  5000K

**Function** F1: F2: + F3: + F4: + + F5: + F6: + +

**Electrical Parameters** AC 200-240V PF ≥0.95 THD <15% Flicker Free

**Photometric Parameters** 100 LM/W 120 LM/W CR>80 SDCM <5 LM79 TM-21 ERP2.0

**IP Rating** IP20

**Finish** White Black

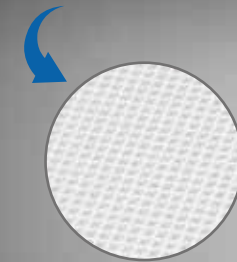

Eye Protection  
Anti-Glare  
UGR<19 Low Glare  
No Flicker, No noise

Prismatic

PCB + LED + Metal plate assembly

PS diffuser as the light guide

Prismatic diffuser for UGR<19



Aluminum outer ring

The aluminum outer ring provide the white and black color

Installation junction with functional module

- Standard ON/OFF
- Standard+ 3h Emergency
- Standard+ Microwave
- Standard+ 3h Emergency + Microwave



## LEO R355A CL200

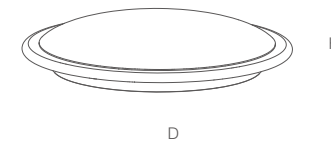

Leo series is an IP20 ceiling for indoor use, It use the aluminum case as heat sink and easy installation.  
130LM/W output make the LEO ceiling light widely use on various of indoor applications .

### Features

- > Up to 130 LM/W@ 3600LM
- > Aluminum housing + PC cover
- > Various of function options
- > Warranty: 5 years

### Data Sheet

Order Code	Rated Power	Lumen	LM/W	Flicker Free	Dimension (mm)	GW/CTN	QTY/CTN
CL200-35W-KT1-20F01-00	20W	typ.3600	typ.130	Y	D355xH100	10.5kg	10pcs
CL200-35W-KT1-30F01-00	30W	typ.3900	typ.130	Y	D355xH100	10.5kg	10pcs

**CCT**

Single Color: 3000K, 4000K, 5000K, 6000K  
Tri-color: 2700K, 3000K, 3500K, 4000K, 4500K, 5000K, 5500K, 6000K

**Function**

F1: ON/OFF  
F2: ON/OFF + Emergency  
F3: ON/OFF + MS  
F4: ON/OFF + Emergency + MS  
F5: ON/OFF + Self-EM  
F6: ON/OFF + Self-EM + MS

**Electrical Parameters**

AC 200-240V, PF ≥0.95, THD <15%, Flicker Free

**Photometric Parameters**

100 LM/W, 130 LM/W, CRI>80 SDCM <5, LM79 TM-21, ERP2.0

**IP Rating**

IP20

**Finish**

White, Black



# LEO R435A CL210

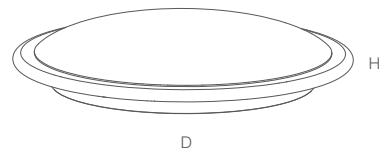

Leo series is an IP20 ceiling for indoor use, It use the aluminum case as heat sink and easy installation. 130LM/W output make the LEO ceiling light widely use on various of indoor applications .

### Features

- > Up to 130 LM/W@ 3900LM
- > Aluminum housing + PC cover
- > Various of function options
- > Warranty: 5 years

**CCT** Single Color 3000K  
4000K  
5000K  
6000K Tri-color 3000K  
4000K  
5000K  
6000K

**Function**

F1: ON/OFF  
 F2: ON/OFF + Emergency  
 F3: ON/OFF + MS  
 F4: ON/OFF + Emergency + MS  
 F5: ON/OFF + Self EM  
 F6: ON/OFF + Self EM + MS

**Electrical Parameters**

AC 200-240V, PF ≥0.95, THD <15%, Flicker Free

**Photometric Parameters**

100 LM/W, CRI>80 SDCM <5, LM79 TM-21, ERP2.0

**IP Rating** IP20

**Finish** White Black

### Data Sheet

Order Code	Rated Power	Lumen	LM/W	Flicker Free	Dimension (mm)	GW/CTN	QTY/CTN
CL210-43W-KT1-20F01-00	20W	typ.3600	typ.130	Y	D435xH100	12kg	5pcs
CL210-43W-KT1-30F01-00	30W	typ.3900	typ.130	Y	D435xH100	12kg	5pcs



**Aluminum bottom case**

Aluminum case with the clips inside to support the gear tray installation

**Polycarbonate Cover**

Made from virgin polycarbonate achieving high transmittance of 80% and vandal resistance rating of IK08.

**Multifunctional Gear Tray**

Standard ON/OFF  
 Standard+ 3h Emergency  
 Standard+ Microwave  
 Standard+ 3h Emergency + Microwave



## Backlit Panel PN100 | HB | UGR>19

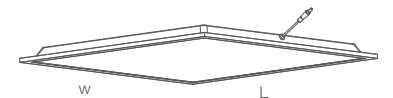

PN100 Back-lit Panel light is a direct lighting with external driver, adopts SMD led with optical lens to provide a uniform light effect, no LGP design makes the panel light more cost effective, high lumen efficiency available with 105lm/w, 120lm/w, 140lm/w, 160lm/w. Recessed, suspended, and surface mounted installation available.

- ▶ **Features**
  - > Ultra flat casing: 32mm
  - > Up to 160lm/w@8000LM
  - > White frame color: RAL9016
  - > Flicker free & 5 years warranty

### ▶ Data Sheet

Order Code	Rated Power	Lumen	LM/W	Flicker Free	Dimension (mm)	GW/CTN	QTY/CTN
PN100-22W-SN1-30F01-00	30W	typ.4800	typ.160	Y	L595 X W595 X H32	24.0kg	10pcs
PN100-41W-SN1-30F01-00	30W	typ.4200	typ.140	Y	L1195 X W295 X H32	12.0kg	5pcs
PN100-42W-SN1-50F01-00	50W	typ.8000	typ.160	Y	L1195 X W595 X H32	24.0kg	5pcs
PN100-62W-SN1-30F01-00	30W	typ.4800	typ.160	Y	L620 X W620 X H32	24.5kg	10pcs

- ▶ **CCT**
  - Single Color: 3000K, 4000K, 5000K, 6000K
  - Tri-color: 2700K, 3000K, 3500K, 4000K, 4500K, 5000K, 5500K, 6000K
- ▶ **Function**
  - ON/OFF
  - 1-10V Dimming
  - DALI
  - Emergency
- ▶ **Electrical Parameters**
  - AC 200-240V
  - PF ≥0.95
  - THD <15%
  - Flicker Free
- ▶ **Photometric Parameters**
  - 105/120 LM/W
  - 140/160 LM/W
  - CRI>80 SDCM <5
  - LM79 TM-21
  - ERP2.0
- ▶ **Installation**
  - Recessed
  - Surface Mounted
  - Suspension
- ▶ **IP Rating**
  - IP20
  - IP44





Prismatic

## Backlit Panel PN110 | TP(b) | UGR>19

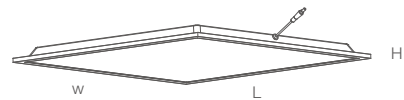

PN110 Back-lit Panel light is a direct lighting with TP(b) fire rated, adopts SMD led with optical lens to provide a uniform light effect, no LGP design makes the panel light more cost effective, high lumen efficiency available with 105lm/w, 120lm/w, 140lm/w, 160lm/w. Recessed, suspended, and surface mounted installation available.

### Features

- > Ultra flat casing: 32mm
- > Up to 160lm/w@8000LM
- > White frame color: RAL9016
- > Flicker free & 5 years warranty

### Data Sheet

Order Code	Rated Power	Lumen	LM/W	Flicker Free	Dimension (mm)	GW/CTN	QTY/CTN
PN110-22W-SN1-30F01-00	30W	typ.4800	typ.160	Y	L595 X W595 X H32	24.0kg	10pcs
PN110-41W-SN1-30F01-00	30W	typ.4200	typ.140	Y	L1195 X W295 X H32	12.0kg	5pcs
PN110-42W-SN1-50F01-00	50W	typ.8000	typ.160	Y	L1195 X W595 X H32	24.0kg	5pcs
PN110-62W-SN1-30F01-00	30W	typ.4800	typ.160	Y	L620 X W620 X H32	24.5kg	10pcs

CCT: Single Color (3000K, 4000K, 5000K, 6000K), Tri-color

Function: ON/OFF, 1-10V Dimming, DALI, Emergency, TP(b)

Electrical Parameters: AC 200-240V, PF ≥0.95, THD <15%, Flicker Free

Photometric Parameters: 105/120 LM/W, 140/160 LM/W, CRI>80 SDCM <5, LM79 TM-21, ERP2.0

Installation: Recessed, Surface Mounted, Suspension

IP Rating: IP20, IP44

## Backlit Panel PN120 | HB | UGR<19

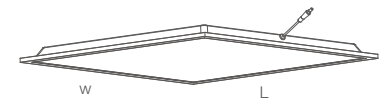

PN120 Back-lit Panel light is a direct lighting with low glare UGR<19, adopts SMD led with optical lens to provide a uniform light effect, no LGP design makes the panel light more cost effective, high lumen efficiency available with 105lm/w, 120lm/w, 140lm/w, 150lm/w. Recessed, suspended, and surface mounted installation available.

### Features

- > Ultra flat casing: 32mm
- > Up to 150lm/w@7500LM, UGR<19
- > White frame color: RAL9016
- > Flicker free & 5 years warranty

### Data Sheet

Order Code	Rated Power	Lumen	LM/W	Flicker Free	Dimension (mm)	GW/CTN	QTY/CTN
PN120-22W-SN1-30F01-00	30W	typ.4500	typ.150	Y	L595 X W595 X H32	24.0kg	10pcs
PN120-41W-SN1-30F01-00	30W	typ.4200	typ.140	Y	L1195 X W295 X H32	12.0kg	5pcs
PN120-42W-SN1-50F01-00	50W	typ.7500	typ.150	Y	L1195 X W595 X H32	24.0kg	5pcs
PN120-62W-SN1-30F01-00	30W	typ.4500	typ.150	Y	L620 X W620 X H32	24.5kg	10pcs

CCT: Single Color (3000K, 4000K, 5000K, 6000K), Tri-color

Function: ON/OFF, 1-10V Dimming, DALI, Emergency

Electrical Parameters: AC 200-240V, PF ≥0.95, THD <15%, Flicker Free

Photometric Parameters: 105/120 LM/W, 140/150 LM/W, CRI>80 SDCM <5, LM79 TM-21, ERP2.0, UGR <19

Installation: Recessed, Surface Mounted, Suspension

IP Rating: IP20, IP44



Prismatic

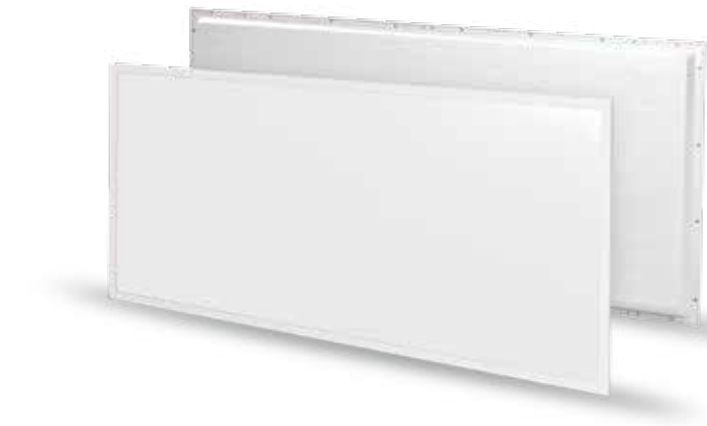

Prismatic

## Backlit Panel PN130 | TP(b) | UGR<19

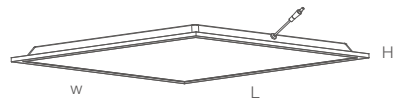

PN130 Back-lit Panel light is a direct lighting with low glare UGR<19, TP(b) fire rated, adopts SMD led with optical lens to provide a uniform light effect, no LGP design makes the panel light more cost effective, high lumen efficiency available with 105lm/w, 120lm/w, 140lm/w, 150lm/w. Recessed, suspended, and surface mounted installation available.

### Features

- > Ultra flat casing: 32mm
- > Up to 150lm/w@7500LM, UGR<19, TP(b)
- > White frame color: RAL9016
- > Flicker free & 5 years warranty

**CCT** Single Color 3000K, 4000K, 5000K, 6000K | Tri-color

**Function** ON/OFF, 1-10V Dimming, DALI, Emergency, TP(b)

**Electrical Parameters** AC 200-240V, PF ≥0.95, THD <15%, Flicker Free

**Photometric Parameters** 105/120 LM/W, 140/150 LM/W, CRI>80 SDCM <5, LM79 TM-21, ERP2.0, UGR <19

**Installation** Recessed, Surface Mounted, Suspension

**IP Rating** IP20, IP44

### Data Sheet

Order Code	Rated Power	Lumen	LM/W	Flicker Free	Dimension (mm)	GW/CTN	QTY/CTN
PN130-22W-SN1-30F01-00	30W	typ.4500	typ.150	Y	L595 X W595 X H32	24.0kg	10pcs
PN130-41W-SN1-30F01-00	30W	typ.4200	typ.140	Y	L1195 X W295 X H32	12.0kg	5pcs
PN130-52W-SN1-50F01-00	50W	typ.7500	typ.150	Y	L1195 X W595 X H32	24.0kg	5pcs
PN130-62W-SN1-30F01-00	30W	typ.4500	typ.150	Y	L620 X W620 X H32	24.5kg	10pcs

## Backlit Panel PN140 | TP(a) | UGR<19

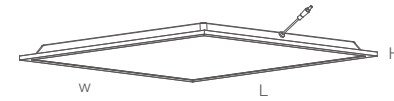

PN140 Back-lit Panel light is a direct lighting with low glare UGR<19, TP(a) fire rated, adopts SMD led with optical lens to provide a uniform light effect, no LGP design makes the panel light more cost effective, high lumen efficiency available with 105lm/w, 120lm/w, 140lm/w, 150lm/w. Recessed, suspended, and surface mounted installation available.

### Features

- > Ultra flat casing: 32mm
- > Up to 150lm/w@7500LM, UGR<19, TP(a)
- > White frame color: RAL9016
- > Flicker free & 5 years warranty

**CCT** Single Color 3000K, 4000K, 5000K, 6000K | Tri-color

**Function** ON/OFF, 1-10V Dimming, DALI, Emergency, TP(a)

**Electrical Parameters** AC 200-240V, PF ≥0.95, THD <15%, Flicker Free

**Photometric Parameters** 105/120 LM/W, 140/150 LM/W, CRI>80 SDCM <5, LM79 TM-21, ERP2.0, UGR <19

**Installation** Recessed, Surface Mounted, Suspension

**IP Rating** IP20, IP44

### Data Sheet

Order Code	Rated Power	Lumen	LM/W	Flicker Free	Dimension (mm)	GW/CTN	QTY/CTN
PN140-22W-SN1-30F01-00	30W	typ.4500	typ.150	Y	L595 X W595 X H32	24.0kg	10pcs
PN140-41W-SN1-30F01-00	30W	typ.4200	typ.140	Y	L1195 X W295 X H32	12.0kg	5pcs
PN140-42W-SN1-50F01-00	50W	typ.7500	typ.150	Y	L1195 X W595 X H32	24.0kg	5pcs
PN140-62W-SN1-30F01-00	30W	typ.4500	typ.150	Y	L620 X W620 X H32	24.5kg	10pcs



# Backlit Panel

PN150 | TP(a) | UGR>19

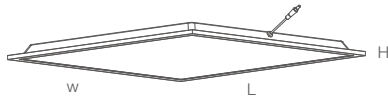

PN150 Back-lit Panel light is a direct lighting with, TP(a) fire rated, adopts SMD led with optical lens to provide a uniform light effect, no LGP design makes the panel light more cost effective, high lumen efficiency available with 105lm/w, 120lm/w, 150lm/w, 160lm/w. Recessed, suspended, and surface mounted installation available.

### Features

- > Ultra flat casing: 32mm
- > Up to 160lm/w@8000LM, TP(a)
- > White frame color: RAL9016
- > Flicker free & 5 years warranty

**CCT** Single Color: 3000K, 4000K, 5000K, 6000K; Tri-color: 2700K, 3000K, 3500K, 4000K

**Function** ON/OFF, 1-10V Dimming, DALI, Emergency, TP(a)

**Electrical Parameters** AC 200-240V, PF ≥0.95, THD <15%, Flicker Free

**Photometric Parameters** 105/120 LM/W, 150/160 LM/W, CRI>80 SDCM <5, LM79 TM-21, ERP2.0

**Installation** Recessed, Surface Mounted, Suspension

**IP Rating** IP20, IP44

### Data Sheet

Order Code	Rated Power	Lumen	LM/W	Flicker Free	Dimension (mm)	GW/CTN	QTY/CTN
PN150-22W-SN1-30F01-00	30W	typ.4800	typ.160	Y	L595 X W595 X H32	24.0kg	10pcs
PN150-41W-SN1-30F01-00	30W	typ.4500	typ.150	Y	L1195 X W295 X H32	12.0kg	5pcs
PN150-42W-SN1-50F01-00	50W	typ.8000	typ.160	Y	L1195 X W595 X H32	24.0kg	5pcs
PN150-62W-SN1-30F01-00	30W	typ.4800	typ.160	Y	L620 X W620 X H32	24.5kg	10pcs





## Edgelit Panel PN200 | HB | UGR>19

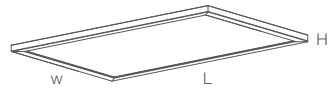

PN200 Edge-lit panel is an effective cost panel. PMMA LGP produce uniform light high lumen output up to 140LM/W, it can fit seamlessly into any work place. It is available in recessed, suspended and surface mounted installation method. It makes the panels widely used on various applications.

### Features

- > Suitably efficient - up to 140 LM/W
- > High Luminous flux - up to 7000 lm
- > PMMA LGP as light guide
- > Extra thin aluminum frame
- > 5 years warranty

### Data Sheet

Order Code	Rated Power	Lumen	LM/W	Flicker Free	Dimension (mm)	GW/CTN	QTY/CTN
PN200-22W-SN1-30F01-00	30W	typ.4200	typ.140	Y	L595 X W595 X H10	13.0kg	4pcs
PN200-41W-SN1-30F01-00	30W	typ.3900	typ.130	Y	L1195 X W295 X H10	16.5kg	5pcs
PN200-42W-SN1-50F01-00	50W	typ.7000	typ.140	Y	L1195 X W595 X H10	12.0kg	2pcs
PN200-62W-SN1-30F01-00	30W	typ.4200	typ.140	Y	L620 X W620 X H10	16.0kg	4pcs

**CCT** Single Color 3000K, 4000K, 5000K, 6000K Tri-color 2700K, 3000K, 3500K, 4000K, 4500K, 5000K, 5500K, 6000K

**Function** ON/OFF, 1-10V Dimming, DALI, Emergency

**Electrical Parameters** AC 200-240V, PF ≥0.95, THD <15%, Flicker Free

**Photometric Parameters** 105/120 LM/W, 130/140 LM/W, CRI>80 SDCM <5, LM79 TM-21, ERP2.0

**Installation** Recessed, Surface Mounted, Suspension

**IP Rating** IP20



Prismatic

## Edgelit Panel PN210 | HB | UGR<19

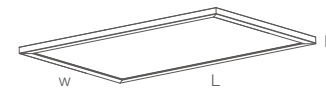

PN210 Edge-lit panel is a non fire rated low glare panel up to 140LM/W. The comfortable light and high color consistency for various applications.

It is available in recessed, suspended and surface mounted installation method. It makes the panels widely used on various applications.

### Features

- > Prismatic UGR<19
- > Suitably efficient - up to 140 LM/W
- > High Luminous flux - up to 7000 lm
- > PMMA LGP as light guide
- > Extra thin aluminum frame
- > 5 years warranty

### Data Sheet

Order Code	Rated Power	Lumen	LM/W	Flicker Free	Dimension (mm)	GW/CTN	QTY/CTN
PN210-22W-SN1-30F01-00	30W	typ.4200	typ.140	Y	L595 X W595 X H10	13.0kg	4pcs
PN210-41W-SN1-30F01-00	30W	typ.3900	typ.130	Y	L1195 X W295 X H10	16.5kg	5pcs
PN210-42W-SN1-50F01-00	50W	typ.7000	typ.140	Y	L1195 X W595 X H10	12.0kg	2pcs
PN210-62W-SN1-30F01-00	30W	typ.4200	typ.140	Y	L620 X W620 X H10	16.0kg	4pcs

**CCT** Single Color 3000K, 4000K, 5000K, 6000K Tri-color 2700K, 3000K, 3500K, 4000K, 4500K, 5000K, 5500K, 6000K

**Function** ON/OFF, 1-10V Dimming, DALI, Emergency

**Electrical Parameters** AC 200-240V, PF ≥0.95, THD <15%, Flicker Free

**Photometric Parameters** 105/120 LM/W, 130/140 LM/W, CRI>80 SDCM <5, LM79 TM-21, ERP2.0, UGR <19

**Installation** Recessed, Surface Mounted, Suspension

**IP Rating** IP20



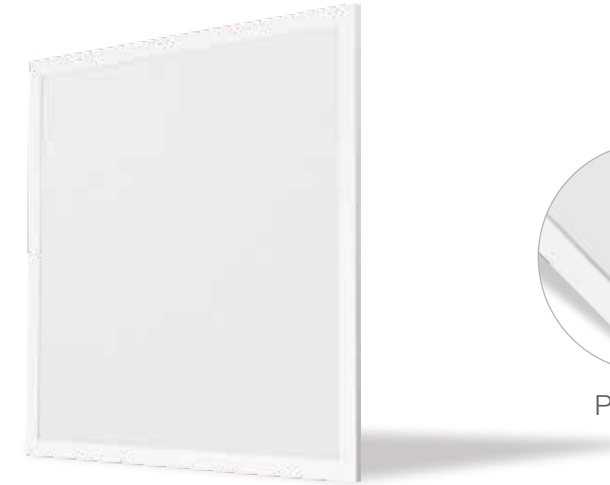

Prismatic

## Edgelit Panel PN220 | TP(b) | UGR>19

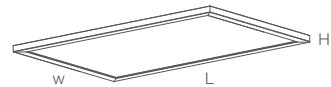

PN220 Edge-lit panel is TP(b) and low glare panel PMMA LGP produce uniform light high lumen up to 140LM/W.

The panels are available in recessed, suspended and surface mounted installation, it makes the panels were widely use on various of applications.

### Features

- > TP(b) fire rated
- > Suitably efficient - up to 140 LM/W
- > High Luminous flux - up to 7000 lm
- > PMMA LGP as light guide
- > Extra thin aluminum frame
- > 5 years warranty

### Data Sheet

Order Code	Rated Power	Lumen	LM/W	Flicker Free	Dimension (mm)	GW/CTN	QTY/CTN
PN220-22W-SN1-30F01-00	30W	typ.4200	typ.140	Y	L595 X W595 X H10	13.0kg	4pcs
PN220-41W-SN1-30F01-00	30W	typ.3900	typ.130	Y	L1195 X W295 X H10	16.5kg	5pcs
PN220-42W-SN1-50F01-00	50W	typ.7000	typ.140	Y	L1195 X W595 X H10	12.0kg	2pcs
PN220-62W-SN1-30F01-00	30W	typ.4200	typ.140	Y	L620 X W620 X H10	16.0kg	4pcs

**CCT** Single Color 3000K, 4000K, 5000K, 6000K Tri-color 2700K, 3000K, 3500K, 4000K, 4500K, 5000K, 5500K, 6000K

**Function** ON/OFF, 1-10V Dimming, DALI, Emergency, TP(b)

**Electrical Parameters** AC 200-240V, PF ≥0.95, THD <15%, Flicker Free

**Photometric Parameters** 105/120 LM/W, 130/140 LM/W, CRI>80 SDCM <5, LM79 TM-21, ERP2.0

**Installation** Recessed, Surface Mounted, Suspension

**IP Rating** IP20

## Edgelit Panel PN230 | TP(b) | UGR<19

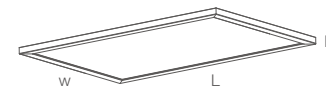

PN230 Edge-lit panel is a TP(b) and low glare panel up to 140LM/W, It is perfect for use in commercial buildings and environments.

It is available in recessed, suspended and surface mounted installation method. It makes the panels were widely use on various of applications

### Features

- > Suitably efficient - up to 140 LM/W
- > High Luminous flux - up to 7000 lm
- > PMMA LGP as light guide
- > Prismatic UGR<19, TP(b) fire-proof
- > Extra thin aluminum frame
- > 5 years warranty

### Data Sheet

Order Code	Rated Power	Lumen	LM/W	Flicker Free	Dimension (mm)	GW/CTN	QTY/CTN
PN230-22W-SN1-30F01-00	30W	typ.4200	typ.140	Y	L595 X W595 X H10	13.0kg	4pcs
PN230-41W-SN1-30F01-00	30W	typ.3900	typ.130	Y	L1195 X W295 X H10	16.5kg	5pcs
PN230-42W-SN1-50F01-00	50W	typ.7000	typ.140	Y	L1195 X W595 X H10	12.0kg	2pcs
PN230-62W-SN1-30F01-00	30W	typ.4200	typ.140	Y	L620 X W620 X H10	16.0kg	4pcs

**CCT** Single Color 3000K, 4000K, 5000K, 6000K Tri-color 2700K, 3000K, 3500K, 4000K, 4500K, 5000K, 5500K, 6000K

**Function** ON/OFF, 1-10V Dimming, DALI, Emergency, TP(b)

**Electrical Parameters** AC 200-240V, PF ≥0.95, THD <15%, Flicker Free

**Photometric Parameters** 105/120 LM/W, 130/140 LM/W, CRI>80 SDCM <5, LM79 TM-21, ERP2.0, UGR <19

**Installation** Recessed, Surface Mounted, Suspension

**IP Rating** IP20

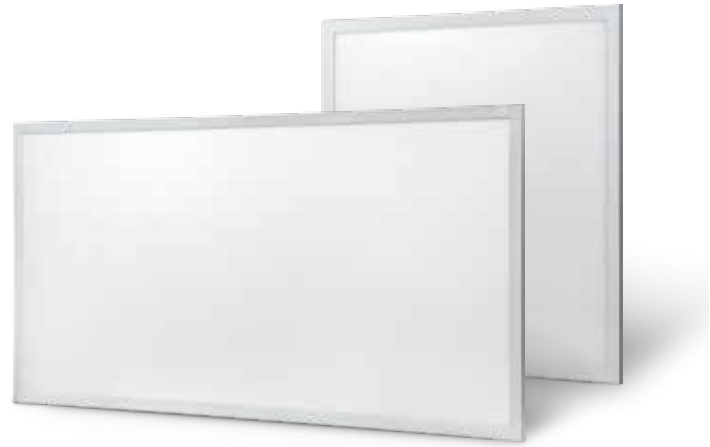

## Edgelit Panel

### PN240 | TP(a) | UGR>19

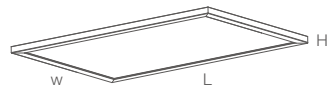

PN240 Edge-lit panel is a TP(a) fire rated panel, It is an energy savings solution with up to 140 lm/W lumen output.

The panels are available in recessed, suspended and surface mounted installation, it makes the panels were widely use on various of applications.

#### Features

- > TP(a) fire-proof
- > Suitably efficient - up to 140 LM/W
- > High Luminous flux - up to 7000 lm
- > PMMA LGP as light guide
- > Extra thin aluminum frame
- > 5 years warranty

CCT: Single Color (3000K, 4000K, 5000K, 6000K), Tri-color (2700K, 3000K, 3500K, 4000K, 4500K, 5000K, 5500K, 6000K)

Function: ON/OFF, 1-10V Dimming, DALI, Emergency, TP(a)

Electrical Parameters: AC 200-240V, PF ≥0.95, THD <15%, Flicker Free

Photometric Parameters: 105/120 LM/W, 130/140 LM/W, CRI>80 SDCM <5, LM79 TM-21, ERP2.0

Installation: Recessed, Surface Mounted, Suspension

IP Rating: IP20

#### Data Sheet

Order Code	Rated Power	Lumen	LM/W	Flicker Free	Dimension (mm)	GW/CTN	QTY/CTN
PN240-22W-SN1-30F01-00	30W	typ.4200	typ.140	Y	L595 X W595 X H10	13.0kg	4pcs
PN240-41W-SN1-30F01-00	30W	typ.3900	typ.130	Y	L1195 X W295 X H10	16.5kg	5pcs
PN240-42W-SN1-50F01-00	50W	typ.7000	typ.140	Y	L1195 X W595 X H10	12.0kg	2pcs
PN240-62W-SN1-30F01-00	30W	typ.4200	typ.140	Y	L620 X W620 X H10	16.0kg	4pcs



Prismatic

## Edgelit Panel

### PN250 | TP(a) | UGR<19

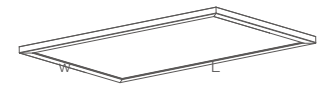

PN250 Edge-lit panel is a high end technology with TP(a) fire rated and Low glare . It is up to 140 lm/W lumen output. The various of installation method and professional features make this panel were widely use on office, schools, meeting rooms and commercial applications.

#### Features

- > Prismatic UGR<19
- > TP(a) fire-proof
- > Suitably efficient - up to 140 LM/W
- > High Luminous flux - up to 7000 lm
- > PMMA LGP as light guide
- > Extra thin aluminum frame
- > 5 years warranty

CCT: Single Color (3000K, 4000K, 5000K, 6000K), Tri-color (2700K, 3000K, 3500K, 4000K, 4500K, 5000K, 5500K, 6000K)

Function: ON/OFF, 1-10V Dimming, DALI, Emergency, TP(a)

Electrical Parameters: AC 200-240V, PF ≥0.95, THD <15%, Flicker Free

Photometric Parameters: 105/120 LM/W, 130/140 LM/W, CRI>80 SDCM <5, LM79 TM-21, ERP2.0, UGR <19

Installation: Recessed, Surface Mounted, Suspension

IP Rating: IP20

#### Data Sheet

Order Code	Rated Power	Lumen	LM/W	Flicker Free	Dimension (mm)	GW/CTN	QTY/CTN
PN250-22W-SN1-30F01-00	30W	typ.4200	typ.140	Y	L595 X W595 X H10	13.0kg	4pcs
PN250-41W-SN1-30F01-00	30W	typ.3900	typ.130	Y	L1195 X W295 X H10	16.5kg	5pcs
PN250-42W-SN1-50F01-00	50W	typ.7000	typ.140	Y	L1195 X W595 X H10	12.0kg	2pcs
PN250-62W-SN1-30F01-00	30W	typ.4200	typ.140	Y	L620 X W620 X H10	16.0kg	4pcs

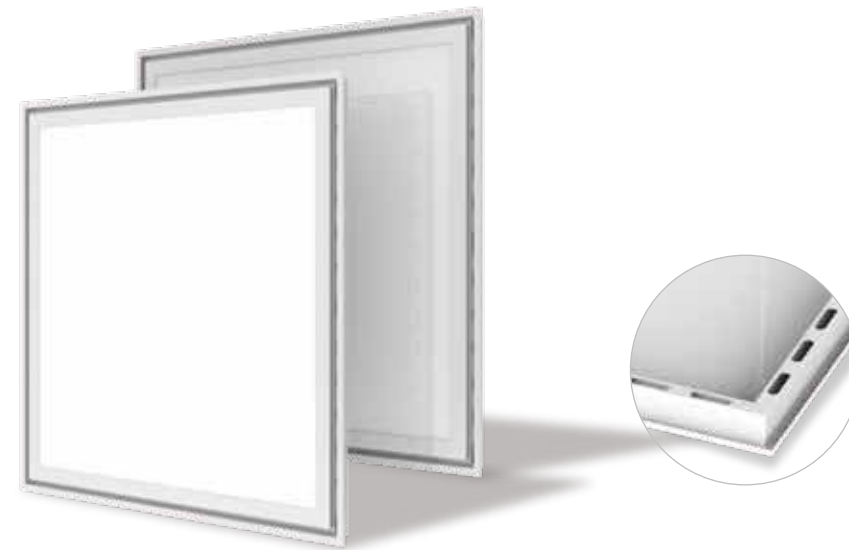

## Air Handling Panel

PN300 | TP(a) | UGR<19

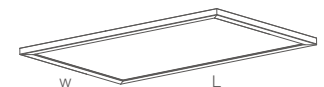

Air Handling Panel Light is not only looks clean and pleasing but also result in visual comfort and good feeling for employees in the offices. Heat transfer, which's important to lighting lifespan, remains efficient due to excellent air-handing and air return over entire space. In a office ventilated with good air quality and provided with excellent thermal comfort, the employees will feel more satisfied and happier, playing an crucial role in productivity and positivity.

### Features

- > Up to 140lm/w
- > Special design for air handling
- > Prismatic UGR<19
- > PMMA LGP
- > 5 years warranty

### Data Sheet

Order Code	Rated Power	Lumen	LM/W	Flicker Free	Dimension (mm)	GW/CTN	QTY/CTN
PN300-21W-SN1-20F01-00	20W	typ.2400	typ.120	Y	L595 X W295 X H25	24.0kg	10pcs
PN300-22W-SN1-32F01-00	32W	typ.4480	typ.140	Y	L595 X W595 X H25	21.0kg	5pcs
PN300-41W-SN1-32F01-00	32W	typ.4480	typ.140	Y	L1195 X W295 X H25	21.0kg	5pcs
PN300-42W-SN1-50F01-00	50W	typ.7000	typ.140	Y	L1195 X W595 X H25	44.0kg	5pcs

**CCT** Single Color 3000K, 4000K, 5000K, 6000K | Tri-color 2700K, 3000K, 3500K, 4000K, 4500K, 5000K, 5500K, 6000K

**Function** ON/OFF, 1-10V Dimming, DALI, Emergency, TP(a)

**Electrical Parameters** AC 200-240V, PF ≥0.95, THD <15%, Flicker Free

**Photometric Parameters** 105/120 LM/W, 130/140 LM/W, CRI>80 SDCM <5, LM79 TM-21, ERP2.0, UGR <19

**Installation** Recessed, Surface Mounted, Suspension

**IP Rating** IP20

**Finish** White, Black

# Upscale Panel

## PN400

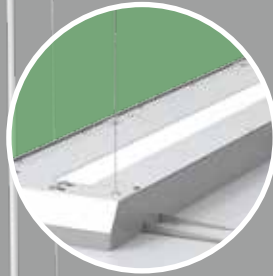
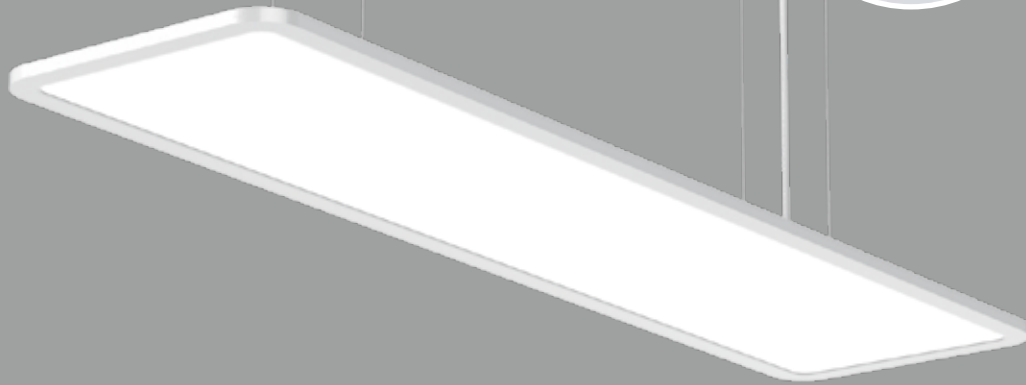

Finish  White  Black

Upscale Panel light is a low UGR suspended up & down panel constructed from Aluminium and rated to IP20. The fitting comes with an integral driver. Colour consistency is adhered to with a 3-Step MacAdams Ellipse binning strategy alongside an LED chipset at CRI>80 ensuring light quality. Available as Switched, 1-10V and DALI dimming options in 3000K 4000K 5000K colour temperature.

### Features

- > Various of functions for options
- > High lumen output at 120LM/W UGR<19
- > CCT: 3000-4000-5000K
- > 5 years warranty

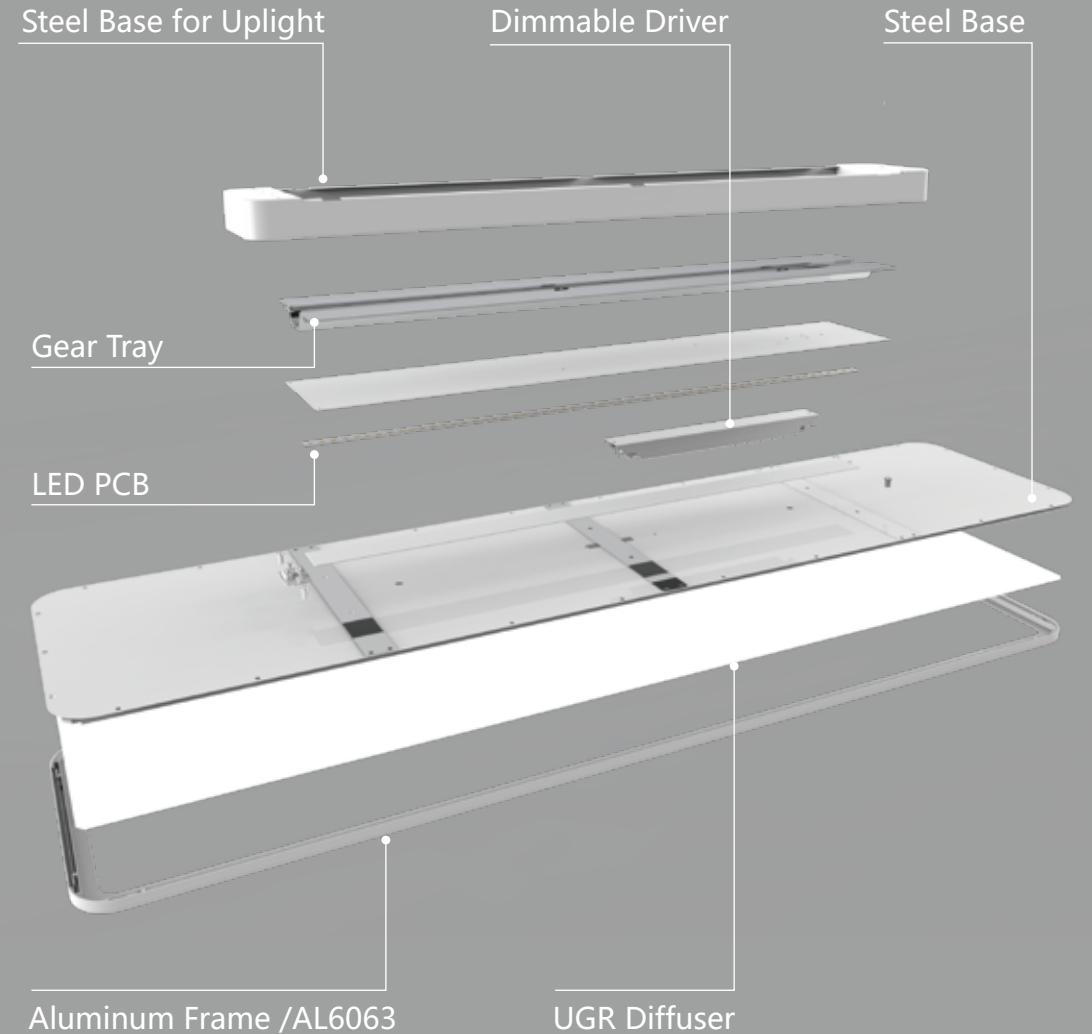

### ▶ Data Sheet

Order Code	Rated Power	Lumen	LM/W	Flicker Free	Dimension (mm)	GW/CTN	QTY/CTN
PN400-22W-SN1-19F01-00	19W	typ.4320	typ.120	Y	L595 X W295 X H50	5.5kg	1pcs
PN400-41W-SN1-36F01-00	36W	typ.4320	typ.120	Y	L1195 X W295 X H50	8.5kg	1pcs





## EVO Down Light DL100

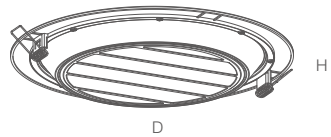

Evo down light is new cost-effective backlit down light. It uses the plastic and steel bottom case.

The Evo down light offers 6 different dimensions and function options .

This cost effective down light makes more and more clients interested in it and use it on different applications.

### Features

- > Cost-effective down light
- > Various of dimensions
- > Recessed Installation
- > Package : Standard or color box

CCT Single Color 3000K 4000K 5000K 6000K

Function   

### Electrical Parameters

AC 200-240V PF ≥0.95 THD <15% Flicker Free

### Photometric Parameters

80 LM/W 110 LM/W CRI>80 SDCM <5 LM79 TM-21 ERP2.0

### Data Sheet

Order Code	Wattage	Lumen	LM/W	Flicker Free	Dimension (mm)	Cut-out(mm)	GW/CTN	QTY/CTN
DL100-09W-SN1-04F01-00	4W	typ.320	typ.80	Y	∅90x25	∅72	7.5kg	40pcs
DL100-12W-SN1-08F01-00	8W	typ.640	typ.80	Y	∅120x25	∅107	5.2kg	20pcs
DL100-17W-SN1-12F01-00	12W	typ.1200	typ.100	Y	∅170x25	∅156	4.6kg	10pcs
DL100-20W-SN1-15F01-00	15W	typ.1500	typ.100	Y	∅200x25	∅185	5.3kg	10pcs
DL100-34W-SN1-18F01-00	18W	typ.1980	typ.110	Y	∅240x25	∅225	6.6kg	10pcs
DL100-30W-SN1-22F01-00	22W	typ.2420	typ.110	Y	∅300x25	∅280	9.0kg	10pcs



## Slim Down Light DL200

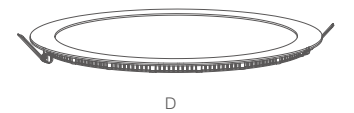

Slim Downlight is a round led panel light with an extra thin die-cast case. It uses the LGP as the light guide.

The 6 dimensions make the slim down widely used in various of different application.

### Features

- > Full range sizes are available
- > Recessed installation
- > Die casting aluminum case
- > Package : Standard or color box

CCT Single Color 3000K 4000K 5000K 6000K

Function   

### Electrical Parameters

AC 200-240V PF ≥0.95 THD <15% Flicker Free

### Photometric Parameters

80 LM/W 110 LM/W CRI>80 SDCM <5 LM79 TM-21 ERP2.0

### Data Sheet

Order Code	Wattage	Lumen	LM/W	Flicker Free	Dimension (mm)	Cut-out(mm)	GW/CTN	QTY/CTN
DL200-09W-SN1-04F01-00	4W	typ.320	typ.80	Y	∅88x25	∅65	7.5kg	40pcs
DL200-12W-SN1-08F01-00	8W	typ.640	typ.80	Y	∅120x25	∅105	5.2kg	20pcs
DL200-17W-SN1-12F01-00	12W	typ.1200	typ.100	Y	∅170x25	∅155	4.6kg	10pcs
DL200-19W-SN1-15F01-00	15W	typ.1500	typ.100	Y	∅190x25	∅175	5.3kg	10pcs
DL200-24W-SN1-18F01-00	18W	typ.1980	typ.110	Y	∅240x25	∅225	6.6kg	10pcs
DL200-30W-SN1-22F01-00	22W	typ.2420	typ.110	Y	∅300x25	∅275	9.0kg	10pcs



# Halo Down Light DL300

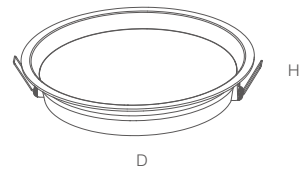

Halo Downlight, die casting aluminum housing design effectively reduce the UGR index. Interchangeable CCT with a slide switch is available.

### Features

- > Die-cast housing as heat sink
- > Recessed installation
- > Full range dimension from 2.5 to 8 inches
- > Package : Standard or color box

**CCT** Single Color 3000K, 4000K, 5000K, 6000K Tri-color 2700K, 3000K, 3500K, 4000K, 4500K, 5000K, 5500K, 6000K

**Function** ON/OFF, 1-10V Dimming, DALI, Emergency

**Electrical Parameters** AC 200-240V, PF ≥0.95, THD <15%, Flicker Free

**Photometric Parameters** 100 LM/W, 120 LM/W, CRI>80 SDCM <5, LM79 TM-21, ERP2.0

Dimension: 2.5 / 4 / 5 / 6 / 8 inches



### Data Sheet

Order Code	Wattage	Lumen	LM/W	Flicker Free	Dimension (mm)	Cut-out(mm)	GW/CTN	QTY/CTN
DL300-02W-SN1-05F01-00	5W	typ.450	typ.90	Y	∅90x40	∅80	5.6kg	20pcs
DL300-03W-SN1-09F01-00	9W	typ.1050	typ.120	Y	∅120x40	∅105	6.8kg	20pcs
DL300-04W-SN1-12F01-00	12W	typ.1440	typ.120	Y	∅145x40	∅130	8.0kg	20pcs
DL300-06W-SN1-20F01-00	20W	typ.2400	typ.120	Y	∅175x40	∅160	10.5kg	20pcs
DL300-08W-SN1-30F01-00	30W	typ.3600	typ.120	Y	∅220x40	∅205	7.5kg	10pcs



# Halo Down Light DL400

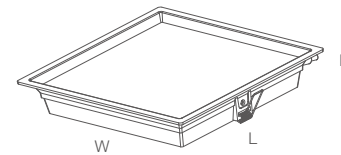

Halo Downlight, die casting aluminum housing design effectively reduce the UGR index. Interchangeable CCT with slide switch is available.

### Features

- > Die-cast housing as heat sink
- > Recessed installation
- > Full range dimension from 2.5 to 8 inches
- > Package : Standard or color box

**CCT** Single Color 3000K, 4000K, 5000K, 6000K Tri-color 2700K, 3000K, 3500K, 4000K, 4500K, 5000K, 5500K, 6000K

**Function** ON/OFF, 1-10V Dimming, DALI, Emergency

**Electrical Parameters** AC 200-240V, PF ≥0.95, THD <15%, Flicker Free

**Photometric Parameters** 100 LM/W, 120 LM/W, CRI>80 SDCM <5, LM79 TM-21, ERP2.0

Dimension: 2.5 / 4 / 5 / 6 / 8 inches



### Data Sheet

Order Code	Wattage	Lumen	LM/W	Flicker Free	Dimension (mm)	Cut-out(mm)	GW/CTN	QTY/CTN
DL400-02W-SN1-05F01-00	5W	typ.450	typ.90	Y	L90 X W90 X H40	80x80	6.0kg	20pcs
DL400-03W-SN1-09F01-00	9W	typ.1050	typ.120	Y	L120 X W120 X H40	105x105	7.6kg	20pcs
DL400-04W-SN1-12F01-00	12W	typ.1440	typ.120	Y	L145 X W145 X H40	130x130	9.2kg	20pcs
DL400-06W-SN1-20F01-00	20W	typ.2400	typ.120	Y	L170 X W170 X H40	160x160	11.5kg	20pcs
DL400-08W-SN1-30F01-00	30W	typ.3600	typ.120	Y	L220 X W220 X H40	205x205	8.9kg	10pcs



# T8 LED Tube

TU08

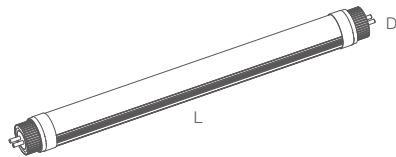

The T8 LED tube is often used with office lighting and warehouse applications and can be used in both indirect and parabolic light fixtures. The T8 tube with high lumen efficacy 160lm/w can save you more money. It's the best replacement for the fluorescent lamp.

### Features

- > TUV/CE/ROHS approval
- > Rotatable end cap
- > Up to 60% energy savings
- > 50,000 hours life span & 5 years warranty
- > Pink color for meat

CCT Single Color 3000K 4000K 5000K 6000K

Function

### Electrical Parameters

AC 200-240V	PF ≥0.95	THD <15%	Flicker Free
----------------	-------------	-------------	-----------------

### Photometric Parameters

100/120 LM/W	140/160 LM/W	CRB-80 SDCM <5	LM79 TM-21	ERP2.0
-----------------	-----------------	----------------------	---------------	--------

### Wiring

Single wiring	Double wiring
------------------	------------------

### Data Sheet

Order Code	Rated Power	Lumen	LM/W	Flicker Free	Dimension (mm)	GW/CTN	QTY/CTN
TU08-02S-CN1-10F01-00	10W	typ.1600	typ.160	Y	L603 X D26	7.0kg	25pcs
TU08-03S-CN1-12F01-00	12W	typ.1920	typ.160	Y	L913 X D26	12.0kg	25pcs
TU08-04S-CN1-28F01-00	28W	typ.4480	typ.160	Y	L1212 X D26	12.5kg	25pcs
TU08-04S-CN1-22F01-00	22W	typ.3520	typ.160	Y	L1212 X D26	12.5kg	25pcs
TU08-05S-CN1-22F01-00	22W	typ.3520	typ.160	Y	L1513X D26	14.2kg	25pcs
TU08-06S-CN1-30F01-00	30W	typ.4800	typ.160	Y	L1813X D26	17.2kg	25pcs



# T6 LED Tube

TU06

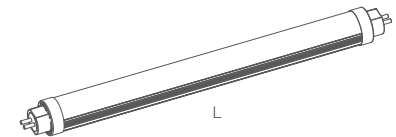

The T6 tube is the best replacement for the T5 fluorescent lamp. It is used with office lighting and warehouse applications and can be used in both indirect and parabolic light fixtures.

### Features

- > TUV/CE/ROHS approval
- > Rotatable end cap
- > Special Design for G5 cap
- > Up to 60% energy savings & 50,000 hours life span
- > Pink color for meat

CCT Single Color 3000K 4000K 5000K 6000K

Function

### Electrical Parameters

AC 200-240V	PF ≥0.95	THD <15%	Flicker Free
----------------	-------------	-------------	-----------------

### Photometric Parameters

100/120 LM/W	140/160 LM/W	CRB-80 SDCM <5	LM79 TM-21	ERP2.0
-----------------	-----------------	----------------------	---------------	--------

### Wiring

Single wiring	Double wiring
------------------	------------------

### Data Sheet

Order Code	Rated Power	Lumen	LM/W	Flicker Free	Dimension (mm)	GW/CTN	QTY/CTN
TU06-02S-CN1-10F01-00	10W	typ.1600	typ.160	Y	L549 X D22	12.5kg	50pcs
TU06-04S-CN1-18F01-00	18W	typ.2880	typ.160	Y	L1148 X D22	12.5kg	25pcs
TU06-05S-CN1-22F01-00	22W	typ.3520	typ.160	Y	L1449 X D22	14.5kg	25pcs
TU06-05S-CN1-25F01-00	25W	typ.4000	typ.160	Y	L1449 X D22	14.5kg	25pcs
TU06-06S-CN1-30F01-00	30W	typ.4800	typ.160	Y	L1749 X D22	18.9kg	25pcs



# Cabinet Light

CB01

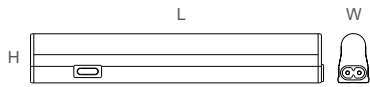

Cabinet lights were designed for use on cupboards, showcases, shopping malls.

Full plastic case and various of connectors make the cabinet light easy multiple link and easy installation.

## Features

- > Ideal for retro-fit of existing T4 and T5 fixtures
- > Full set of connectors and accessories supplied
- > Slimline profile for discreet installation
- > Extruded plastic body
- > 3 years warranty

CCT Single Color 3000K 4000K 5000K 6000K

Function

## Electrical Parameters

AC 200-240V	PF ≥0.95	THD <15%	Flicker Free
----------------	-------------	-------------	-----------------

## Photometric Parameters

100 LM/W	CRi>80 SDCM <5	LM79 TM-21
-------------	----------------------	---------------

Connector Accessories See below page



# Cabinet Light

## Accessories



## Data Sheet

Order Code	Rated Power	Lumen	LM/W	Flicker Free	Dimension (mm)	GW/CTN	QTY/CTN
CB01-02W-GN1-03F01-00	3W	typ.300	typ.100	N	L200 X W23 X H37	15kg	60pcs
CB01-03W-GN1-05F01-00	5W	typ.500	typ.100	N	L300 X W23 X H37	17kg	60pcs
CB01-05W-GN1-08F01-00	8W	typ.800	typ.100	N	L500 X W23 X H37	10kg	30pcs
CB01-09W-GN1-14F01-00	14W	typ.1400	typ.100	N	L900 X W23 X H37	13kg	30pcs
CB01-12W-GN1-16F01-00	16W	typ.1600	typ.100	N	L1200 X W23 X H37	16kg	30pcs





# REVO UFO

## HB100

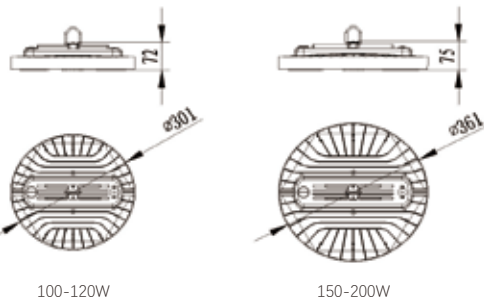

With built-in driver, REVO-UFO is a cost-effective and compact high bay series. Dia.361mm heat sink guarantees good heat dissipation, All of the above features make this UFO were widely use on different industrial applications

### Features

- > 130lm/w and 160lm/w
- > Full wattage:100W, 120W, 150W, 200W.
- > Intelligent control: microwave motion sensor, PIR sensor, CASAMBI wireless control

CCT Single Color 3000K 4000K 5000K 6000K

Function

Electrical Parameters

Photometric Parameters

IP/IK

Installation

### Data Sheet

Order Code	Rated Power	Lumen	LM/W	Flicker Free	Dimension (mm)	GW/CTN	QTY/CTN
HB100-30B-DN1-1AF01-00	100W	typ.13000	typ.130	Y	D301 X H72	12kg	4pcs
HB100-30B-DN1-1BF01-00	120W	typ.15600	typ.130	Y	D301 X H72	12kg	4pcs
HB110-36B-DN1-1BF01-00	150W	typ.19500	typ.130	Y	D361 X H75	14kg	4pcs
HB110-36B-DN1-2AF01-00	200W	typ.26000	typ.130	Y	D361 X H75	14kg	4pcs



### Mounting Options



### Sensor Function



## INTRODUCTION

The ANT-5-4R is a motion sensor that dims lighting from high to low based on movement. This slim, low-profile sensor is designed for installation inside the bottom of a light fixture body. The sensors use microwave sensing technology that reacts to changes in movement within the coverage area. Once the sensor stops detecting movement and the time delay elapses lights will go from high to low mode and eventually to an OFF position if it is desired. Sensors must directly "see" motion of a person or moving object to detect them, so careful consideration must be given to sensor luminaire placement and lens selection. Avoid placing the sensor where obstructions may block the sensor's line of sight.



# Elite UFO HB200

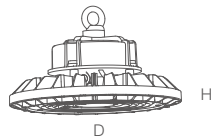

Elite UFO is a new functional highbay light, Can use DIP switch wattage adjustable driver. Available on IP65 connector which make the Elite UFO easy for driver replace and AC wiring.

UP to 190 LM/W makes the Elite UFO deliver the reliable lumen output and lower light decay.

## Features

- > Up to 190lm/W and die-cast case as heat sink
- > Wattage DIP switch adjustable (60%/80%/100%) & Stepless adjustable are available
- > Ripple Lens : 60°/ 90°/ 120°
- > Plug & Play sensor for MS /on/off/1-10V changing is available
- > Optional on IP65 connector for smart driver replace AC wiring
- > D-Mark tested for using on paper /wooden production
- > 5 years warranty

## Data Sheet

Order Code	Rated Power	Wattage Adjustable	Lumen	LM/W	Flicker Free	Dimension (mm)	GW/CTN	QTY/CTN
HB200-24B-DN1-75F01-00	75W	45W/60W/75W	Max.14250	typ.190	Y	D240X H155	3.5kg	1pcs
HB200-24B-DN1-1AF01-00	100W	60W/80W/100W	Max.19000	typ.190	Y	D240X H155	3.5kg	1pcs
HB210-28B-DN1-1BF01-00	150W	90W/120W/150W	Max.28500	typ.190	Y	D280X H163	4.5kg	1pcs
HB220-32B-DN1-2AF01-00	200W	120W/160W/200W	Max.38000	typ.190	Y	D320X H163	5.3kg	1pcs



**CCT** Single Color 3000K 4000K 6000K Tri-color 3000K 4000K 6000K

**Function** ON/OFF 1-10V Dimming DALI MS 1-10V Dimming Emergency

**Electrical Parameters** AC 100-277V PF >0.95 THD <15% Flicker Free

**Photometric Parameters** 160 LM/W 190 LM/W CRI>80 SDCM <5 LM79 TM-21 ERP2.0

**Beam angle** 60° 90° 120°

**IP/IK** IP65 IK10

**Installation** Loop Hanging Hook Mounting Ceiling Mounting Bracket Mounting

# Elite UFO Function Options

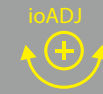

DIP Switch Wattage Adjustable  
Stepless Wattage Adjustable



Smart IP65 Conny Connector, easy to access to wiring to ensure a quick and easy installation.

Smart IP65 Connector, easy for driver replacement

Unique Die-casting Fins heat sink



Plug & Play MS Sensor, easy to change from MS to 1-10V.

Ripple Lens PC Reflector: 60°/ 90°/ 120°





## Mate UFO

### HB400 | Honeycomb

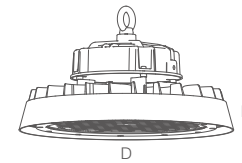

Honeycomb mate UFO is an anti-glare design with UGR<22, The lumen efficiency up to 160lm/W.

Sleek anti glare design and die cast heat sink make the mate UFO widely use suitable on glare applications, Such as sports field, workshop, warehouse, etc.

#### Features

- > Up to 160lm/w
- > Anti-glare UGR<22
- > IP65 / IK10 for all industrial applications
- > Superior honeycomb-reflector-optic with 60° or 90°
- > L80/B10 @ 50.000h
- > D-Mark tested for using on paper / wooden production
- > Warranty: 5 years

#### Data Sheet

Order Code	Rated Power	Lumen	LM/W	Flicker Free	Dimension (mm)	GW/CTN	QTY/CTN
HB400-30B-CN1-1AF01-00	100W	typ.16000	typ.160	Y	D300X H155	4.3kg	1pcs
HB400-30B-CN1-1BF01-00	150W	typ.24000	typ.160	Y	D300X H155	4.3kg	1pcs
HB410-35B-CN1-2AF01-00	200W	typ.32000	typ.160	Y	D350X H155	5.6kg	1pcs
HB410-35B-CN1-2BF01-00	240W	typ.38400	typ.160	Y	D350X H155	5.6kg	1pcs



CCT Single Color **3000K** 4000K 5000K 6000K



#### Electrical Parameters



#### Photometric Parameters



#### Beam angle



#### IP/IK



#### Installation

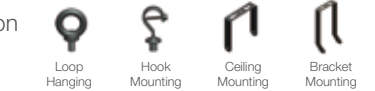





# Mate UFO

## HB420 | Ripple Lens

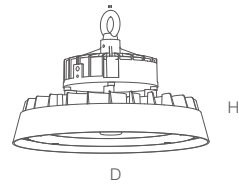

Ripple lens mate UFO provide 60°/90°/120° beam angle, High lumen output up to 180LM/W.

The different beam angle deliver the high Lux output, And the die-cast heat sink helps on the heating dissipation.

All of the above features make this UFO were widely use on different industrial applications

### Features

- > Up to 180lm/w
- > IP65 / IK10
- > Ripple lens optic with 60°/90°/120° beam angle;
- > D-Mark tested for the using on paper/wooden production
- >5 years warranty

### Data Sheet

Order Code	Rated Power	Lumen	LM/W	Flicker Free	Dimension (mm)	GW/CTN	QTY/CTN
HB420-30B-LN1-1AF01-00	100W	typ.18000	typ.180	Y	D300X H155	4.3kg	1pcs
HB420-30B-LN1-1BF01-00	150W	typ.27000	typ.180	Y	D300X H155	4.3kg	1pcs
HB420-35B-LN1-2AF01-00	200W	typ.36000	typ.180	Y	D350X H155	5.6kg	1pcs
HB420-35B-LN1-2BF01-00	240W	typ.43200	typ.180	Y	D350X H155	5.6kg	1pcs

CCT Single Color **3000K** 4000K 5000K 6000K



### Electrical Parameters



### Photometric Parameters



### Beam angle



### IP/IK



### Installation

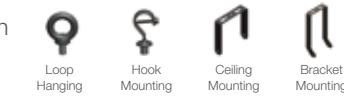

# Mate UFO

## HB430 | Glass Cover

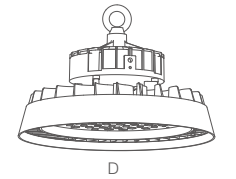

Glass cover mate UFO has a high lighting transmission ,The lumen output reach at 190LM/W,The die-cast heat sink helps on the heating dissipation.

All of the above features make this UFO were widely use on different industrial applications.

### Features

- > Up to 190lm/w
- > Die cast heat sink for heating dissipation
- > IP65 / IK10
- > D-Mark tested for using on paper/wooden production
- > 5 years warranty

### Data Sheet

Order Code	Rated Power	Lumen	LM/W	Flicker Free	Dimension (mm)	GW/CTN	QTY/CTN
HB430-30B-LN1-1AF01-00	100W	typ.19000	typ.190	Y	D300X H155	4.3kg	1pcs
HB430-30B-LN1-1BF01-00	150W	typ.28500	typ.190	Y	D300X H155	4.3kg	1pcs
HB430-35B-LN1-2AF01-00	200W	typ.38000	typ.190	Y	D350X H155	5.6kg	1pcs
HB430-35B-LN1-2BF01-00	240W	typ.45600	typ.190	Y	D350X H155	5.6kg	1pcs

CCT Single Color **3000K** 4000K 5000K 6000K



### Electrical Parameters



### Photometric Parameters



### IP/IK



### Installation







## T-line

### HB500

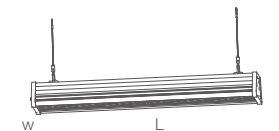

The symmetric honeycomb linear highbay is designed low glare applications up to 160LM/W, The symmetric honeycomb provide 60/90 degree beam angle .

The superior honeycomb -reflector-optic for low glare make this linear highbay be widely use on the industrial and commerical applications which need the low glare lighting emitting.

#### Features

- > Up to 160 lm/w
- > Die-cast case for excellent heat dissipation
- > Symmetric honeycomb for low glare
- > No UV or IR and completely mercury free
- > Various end cap colors available
- > L80/B10 @ 50.000h
- > 5 years warranty

#### Data Sheet

Order Code	Rated Power	Lumen	LM/W	Flicker Free	Dimension (mm)	GW/CTN	QTY/CTN
HB500-02B-CN1-1AF01-00	100W	typ.16000	typ.160	Y	L623 X W138 X H73	5.9kg	1pcs
HB500-03B-CN1-1CF01-00	120W	typ.19200	typ.160	Y	L923 X W138 X H73	7.9kg	1pcs
HB500-03B-CN1-1BF01-00	150W	typ.24000	typ.160	Y	L923 X W138 X H73	7.9kg	1pcs
HB500-04B-CN1-2AF01-00	200W	typ.32000	typ.160	Y	L1223 X W138 X H73	10.0kg	1pcs

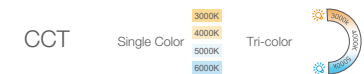

#### Electrical Parameters



#### Photometric Parameters



#### Beam angle



#### IP/IK





# T-line

## HB520

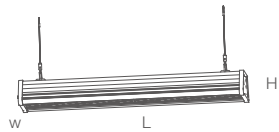

The asymmetric honeycomb linear highbay provide the 60X90 and 90x110 degree beamangle, The asymmetric angle make the highbay deliver a uniform lighting up to 160LM/W

The asymmetric honeycomb reflector also make the linear highbay UGR<22 low glare.

### Features

- > Up to 160 lm/w
- > Die-cast case for excellent heat dissipation
- > Asymmetric honeycomb for low glare UGR<22
- > No UV or IR and completely mercury free
- > Various end cap colors available
- > L80/B10 @ 50.000h
- > 5 years warranty

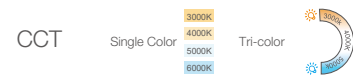

### Electrical Parameters



### Photometric Parameters



### Beam angle

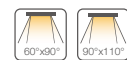

### IP/IK



### Data Sheet

Order Code	Rated Power	Lumen	LM/W	Flicker Free	Dimension (mm)	GW/CTN	QTY/CTN
HB520-02B-CN1-1AF01-00	100W	typ.16000	typ.160	Y	L623 X W138 X H73	5.9kg	1pcs
HB520-03B-CN1-1CF01-00	120W	typ.19200	typ.160	Y	L923 X W138 X H73	7.9kg	1pcs
HB520-03B-CN1-1BF01-00	150W	typ.24000	typ.160	Y	L923 X W138 X H73	7.9kg	1pcs
HB520-04B-CN1-2AF01-00	200W	typ.32000	typ.160	Y	L1223 X W138 X H73	10.0kg	1pcs



# T-line

## HB540

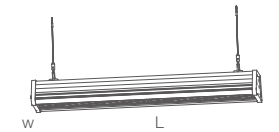

The glass cover linear highbay provide frosted and clear version up to 180 LM/W

The cooling fins aluminum case assures the excellent heating dissipation.

### Features

- > Frosted :170LM/W, Clear :180LM/W
- > Die-cast case for excellent heat dissipation
- > No UV or IR and completely mercury free
- > Various end cap colors available
- > L80/B10 @ 50.000h
- > 5 years warranty



### Electrical Parameters



### Photometric Parameters



### IP/IK



### Data Sheet

Order Code	Rated Power	Lumen	LM/W	Flicker Free	Dimension (mm)	GW/CTN	QTY/CTN
HB540-02B-CN1-1AF01-00	100W	typ.17000	typ.170	Y	L623 X W138 X H73	5.9kg	1pcs
HB540-03B-CN1-1CF01-00	120W	typ.20400	typ.170	Y	L923 X W138 X H73	7.9kg	1pcs
HB540-03B-CN1-1BF01-00	150W	typ.25500	typ.170	Y	L923 X W138 X H73	7.9kg	1pcs
HB540-04B-CN1-2AF01-00	200W	typ.34000	typ.170	Y	L1223 X W138 X H73	10.0kg	1pcs

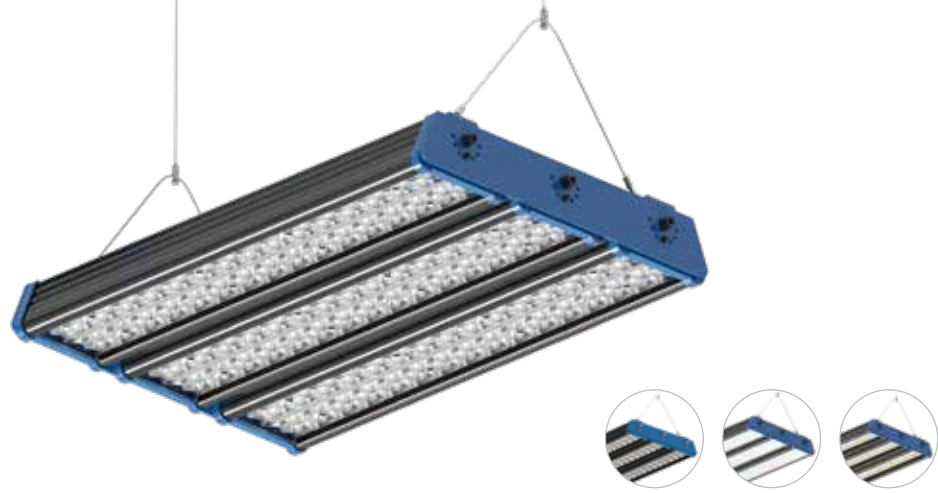

# Modular Highbay

HB600 | 3x100W-60CM

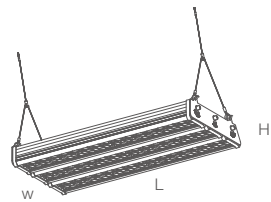

Modular highbay use the 60CM / 90CM / 120CM T-Line unit as the basic unit, Aluminum heat sink deliver the best heating dissipation which make the highbay offer a long life span and lower light decay

The special designed Honeycomb reflectors reduces glaring and provides various symmetric and asymmetric beam angle choices for all possible areas of applications.

## Features

- > Superior honeycomb-reflector-optic for low glare
- > Asymmetric Honeycomb reflector for 60°/90° degree
- > Glass cover up to 180 lm/w
- > Cooling-finings structure for excellent heat dissipation
- > L80/B10 @ 50.000h
- > 5 years warranty

**CCT** Single Color 3000K, 4000K, 5000K, 6000K Tri-color

**Function** ON/OFF, 1-10V Dimming, DALI, MS, Light Sensor, Emergency

**Electrical Parameters** AC 100-277V, PF ≥0.95, THD <15%, Flicker Free

**Photometric Parameters** 140 LM/W, 160 LM/W, 180 LM/W, CRI>80 SDCM <5, LM79 TM-21, ERP2.0

**Cover** Symmetric honeycomb, Asymmetric honeycomb, Glass cover

**Beam angle** 60°, 90°, 60°x90°, 90°x110°, 120°  
Symmetric Honeycomb, Asymmetric Honeycomb, Glass

**IP/IK** IP65, IK10

## Data Sheet

Order Code	Rated Power	Lumen	LM/W	Flicker Free	Dimension (mm)	GW/CTN	QTY/CTN
HB600-02B-CN1-3AF01-00	300W	typ.48000	typ.160	Y	L624 X W438 X H83	15.6kg	1pcs
HB601-02B-CN1-3AF01-00	300W	typ.48000	typ.160	Y	L624 X W438 X H83	15.6kg	1pcs
HB620-02B-CN1-3AF01-00	300W	typ.51000	typ.170	Y	L624 X W438 X H83	15.6kg	1pcs
HB621-02B-CN1-3AF01-00	300W	typ.54000	typ.180	Y	L624 X W438 X H83	15.6kg	1pcs



# Modular Highbay

HB602 | 3x150W-90CM

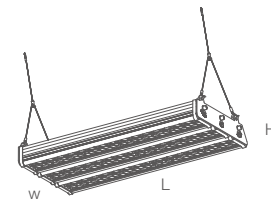

Modular highbay use the 60CM / 90CM / 120CM T-Line unit as the basic unit, Aluminum heat sink deliver the best heating dissipation which make the highbay offer a long life span and lower light decay

The special designed Honeycomb reflectors reduces glaring and provides various symmetric and asymmetric beam angle choices for all possible areas of applications.

## Features

- > Superior honeycomb-reflector-optic for low glare
- > Asymmetric Honeycomb reflector for 60°/90° degree
- > Glass cover up to 180 lm/w
- > Cooling-finings structure for excellent heat dissipation
- > L80/B10 @ 50.000h
- > 5 years warranty

**CCT** Single Color 3000K, 4000K, 5000K, 6000K Tri-color

**Function** ON/OFF, 1-10V Dimming, DALI, MS, Light Sensor, Emergency

**Electrical Parameters** AC 100-277V, PF ≥0.95, THD <15%, Flicker Free

**Photometric Parameters** 140 LM/W, 160 LM/W, 180 LM/W, CRI>80 SDCM <5, LM79 TM-21, ERP2.0

**Cover** Symmetric honeycomb, Asymmetric honeycomb, Glass cover

**Beam angle** 60°, 90°, 60°x110°, 90°x110°, 120°  
Symmetric Honeycomb, Asymmetric Honeycomb, Glass

**IP/IK** IP65, IK10

## Data Sheet

Order Code	Rated Power	Lumen	LM/W	Flicker Free	Dimension (mm)	GW/CTN	QTY/CTN
HB602-03B-CN1-1BF01-00	450W	typ.72000	typ.160	Y	L924 X W438 X H83	19.5kg	1pcs
HB603-03B-CN1-1BF01-00	450W	typ.72000	typ.160	Y	L924 X W438 X H83	19.5kg	1pcs
HB623-03B-CN1-1BF01-00	450W	typ.76500	typ.170	Y	L924 X W438 X H83	19.5kg	1pcs
HB624-03B-CN1-1BF01-00	450W	typ.81000	typ.180	Y	L924 X W438 X H83	19.5kg	1pcs

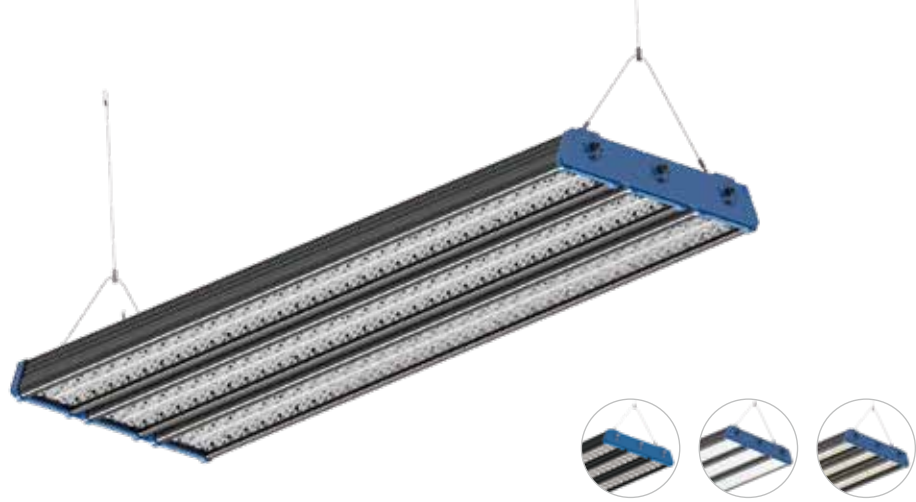

# Modular Highbay product categories

## Modular Highbay

HB604 | 3x200W+120CM

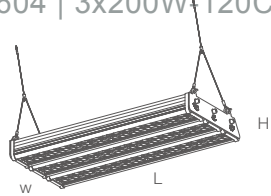

Modular highbay use the 60CM / 90CM / 120CM T-Line unit as the basic unit, Aluminum heat sink deliver the best heating dissipation which make the highbay offer a long life span and lower light decay

The special designed Honeycomb reflectors reduces glaring and provides various symmetric and asymmetric beam angle choices for all possible areas of applications.

### Features

- > Superior honeycomb-reflector-optic for low glare
- > Asymmetric Honeycomb reflector for 60°90° degree
- > Glass cover up to 180 lm/w
- > Cooling-finings structure for excellent heat dissipation
- > L80/B10 @ 50.000h
- > 5 years warranty

### Data Sheet

Order Code	Rated Power	Lumen	LM/W	Flicker Free	Dimension (mm)	GW/CTN	QTY/CTN
HB604-04B-CN1-1BF01-00	600W	typ.96000	typ.160	Y	L1224 X W438 X H83	25.2kg	1pcs
HB605-04B-CN1-1BF01-00	600W	typ.96000	typ.160	Y	L1224 X W438 X H83	25.2kg	1pcs
HB625-04B-CN1-1BF01-00	600W	typ.102000	typ.170	Y	L1224 X W438 X H83	25.2kg	1pcs
HB626-04B-CN1-1BF01-00	600W	typ.108000	typ.180	Y	L1224 X W438 X H83	25.2kg	1pcs



**CCT** Single Color 3000K, 4000K, 5000K, 6000K; Tri-color 3000K, 4000K, 5000K, 6000K

**Function** ON/OFF, 1-10V Dimming, DALI, MS, Daylight Sensor, Emergency

**Electrical Parameters** AC 100-277V, PF ≥0.95, THD <15%, Flicker Free

**Photometric Parameters** 140 LM/W, 160 LM/W, 180 LM/W, CRI>80 SDCM <5, LM79 TM-21, ERP2.0

**Cover** Symmetric honeycomb, Asymmetric honeycomb, Glass cover

**Beam angle** 60°, 90°, 60°x110°, 90°x110°, 120°; Symmetric Honeycomb, Asymmetric Honeycomb, Glass

**IP/IK** IP65, IK10

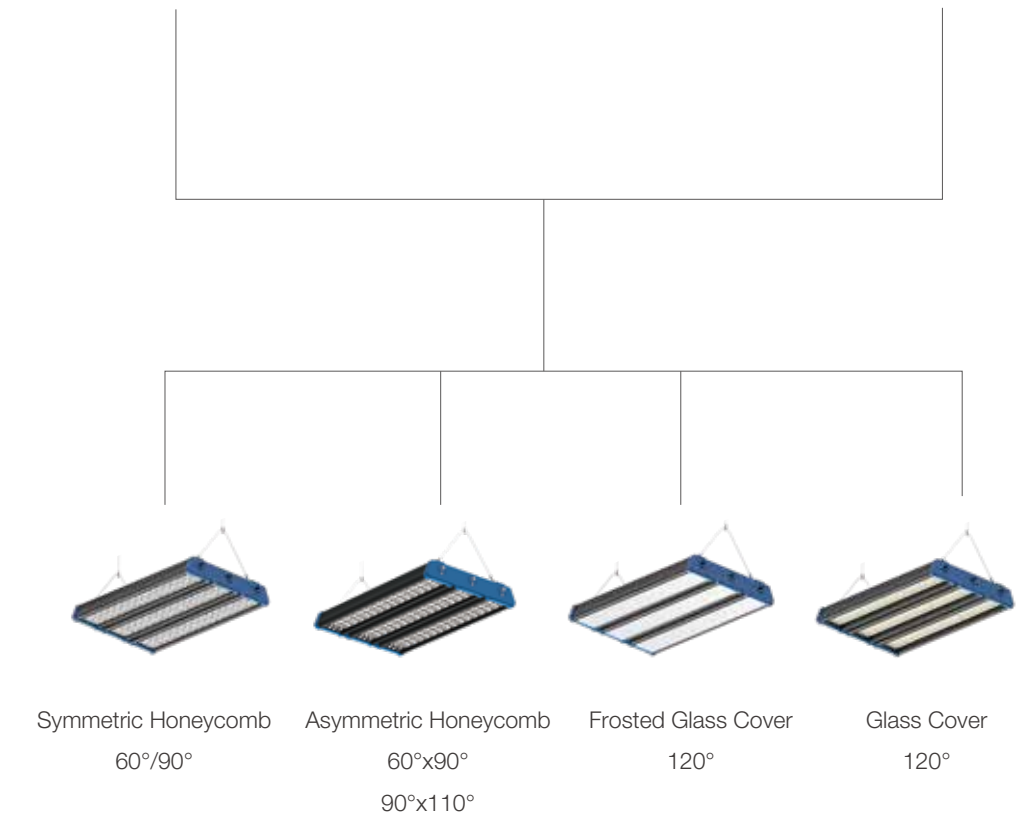



# Contact details

## **IINNO Ltd**

2101A Nan Fung Centre,  
264-298 Castle Peak Road,  
Tsuen Wan, Hong Kong

Tel: +852 2134 9906

+86 (0)769 23010151/2

M: +86 13922905402

Email: [sales@iinno-lighting.com](mailto:sales@iinno-lighting.com)

[www.iinno-lighting.com](http://www.iinno-lighting.com)



