

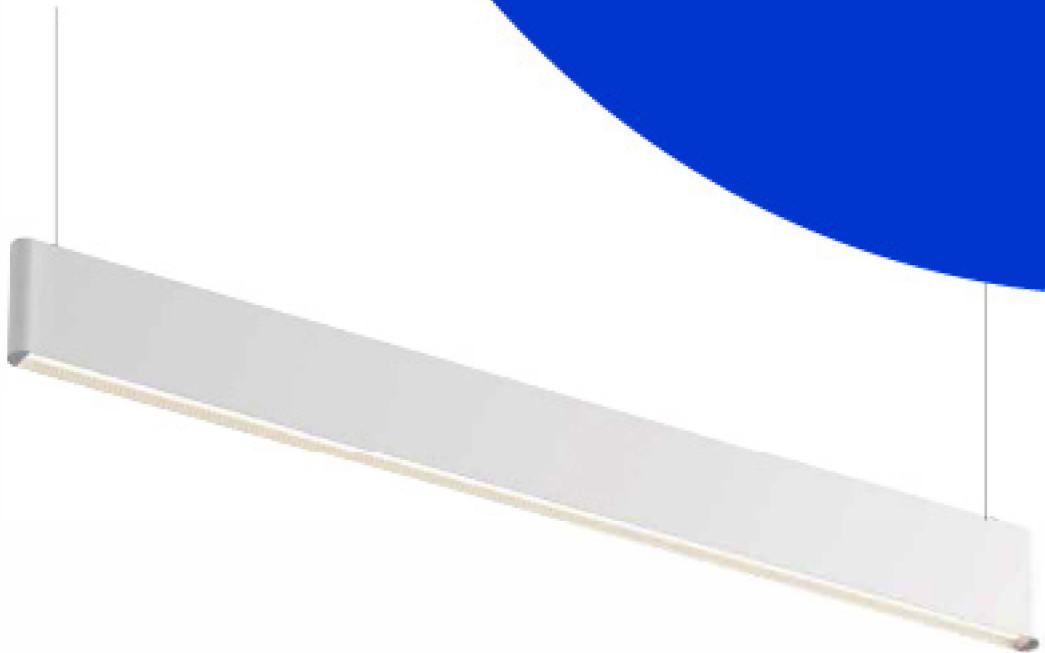

Linear Light Series

iinno Lighting delivers certified, high-performance solutions for commercial, municipal, and industrial use, trusted by developers worldwide for quality, scale, and long-term reliability.





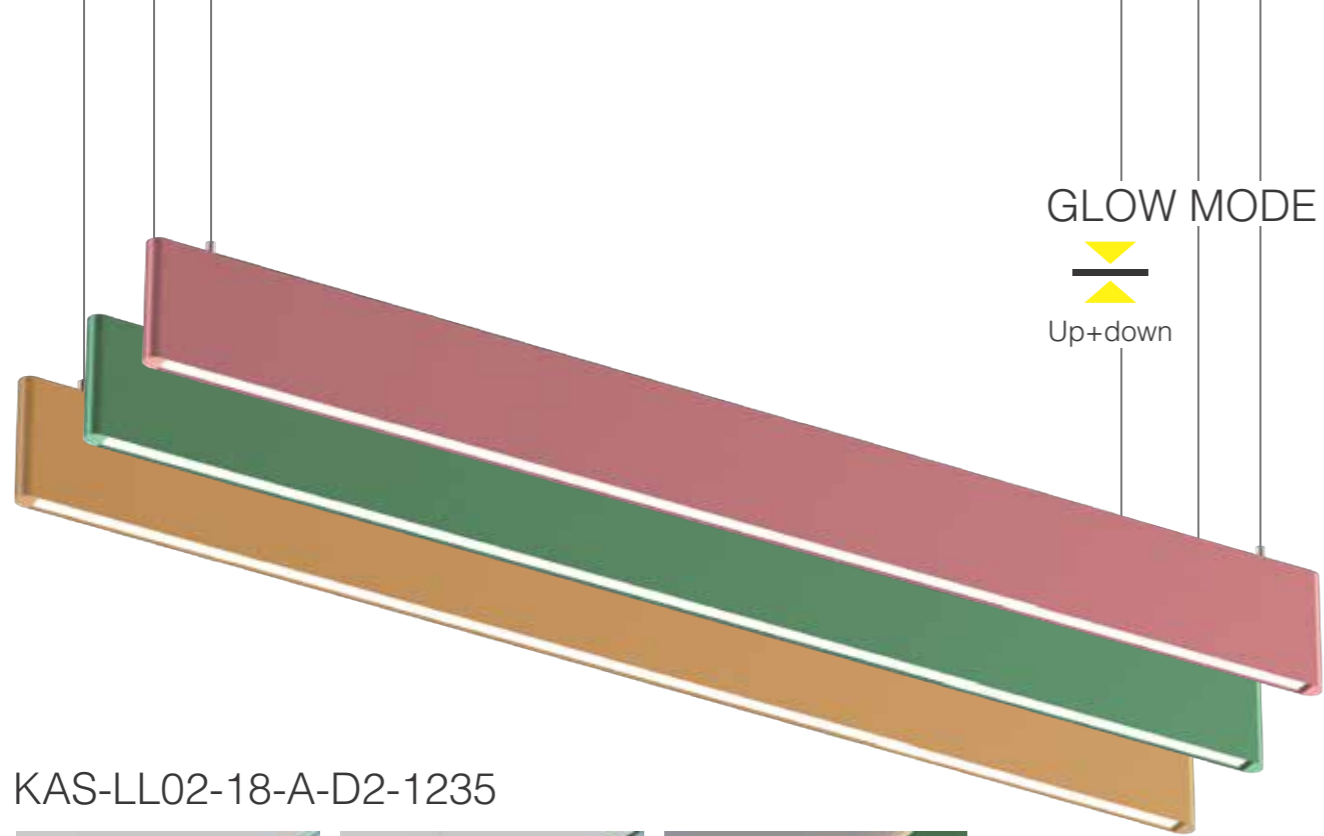

KAS-LL02-18-A-D2-1235



Front detail



Back detail

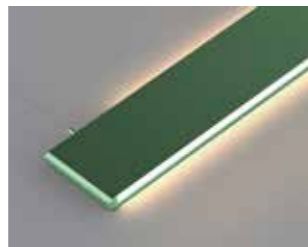

Glow effect



GLOW MODE



KAS-LL02-18-A-D2-1235

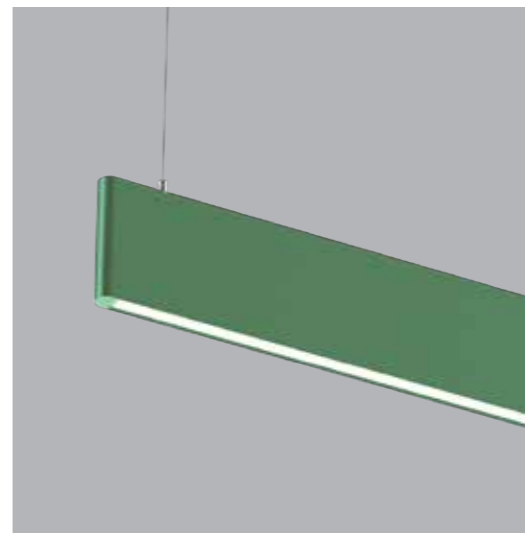
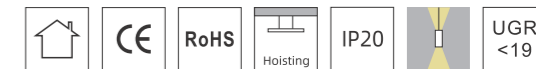

Lifting

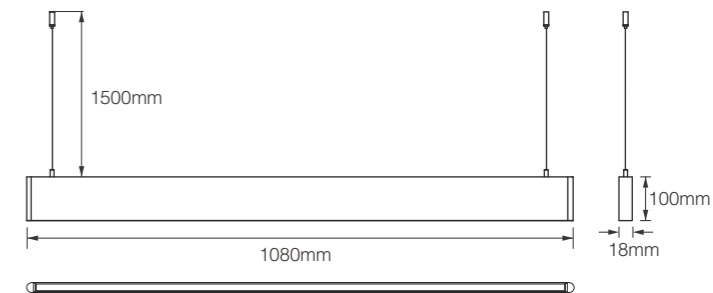

Model	Glow Direction	Power	CRI	CCT	Beam Angle	LED Output	System Output	Dimming Type
KAS-LL02-18-A-D2-1235	Up	15W	90	2700K	110°	1376lm	936lm	ON-OFF 1-10V DALI
	Down	30W	90	2700K	80°	2753lm	1856lm	
	Up	15W	90	3000K	110°	1449lm	985lm	ON-OFF 1-10V DALI
	Down	30W	90	3000K	80°	2898lm	1954lm	
	Up	15W	90	3500K	110°	1536lm	1044lm	ON-OFF 1-10V DALI
	Down	30W	90	3500K	80°	3072lm	2072lm	
	Up	15W	90	4000K	110°	1565lm	1064lm	ON-OFF 1-10V DALI
	Down	30W	90	4000K	80°	3129lm	2110lm	

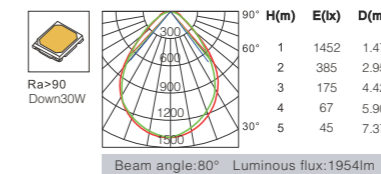
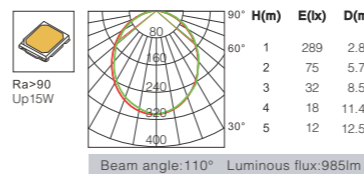

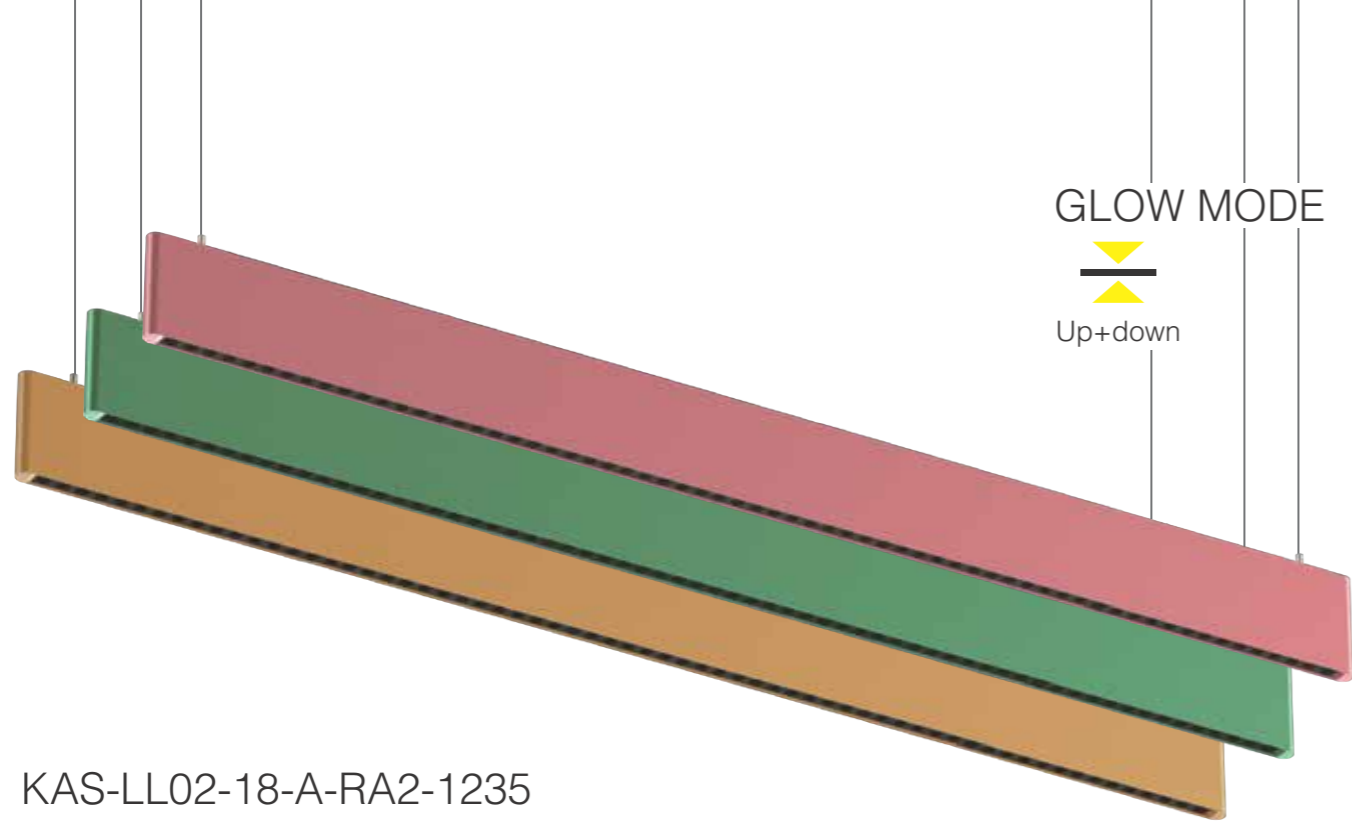

KAS-LL02-18-A-RA2-1235



front detail

Back detail

Glow effect



KAS-LL02-18-A-RA2-1235

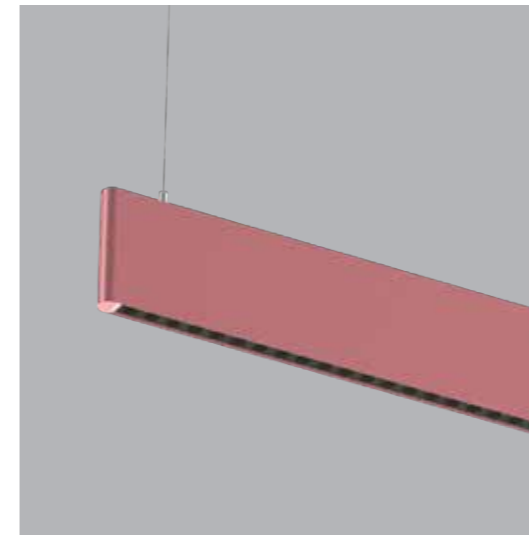

Lifting

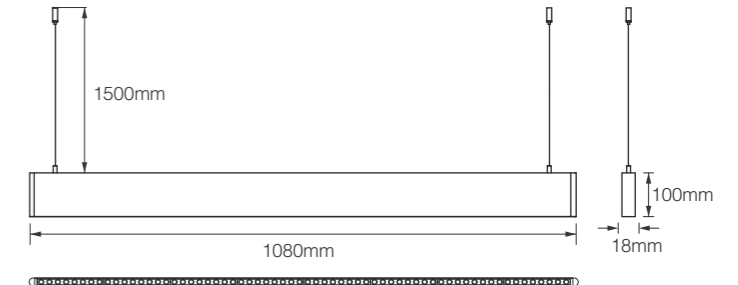

Model	Glow Direction	Power	CRI	CCT	Beam Angle	LED Output	System Output	Dimming Type
KAS-LL02-18-A-RA2-1235 Up15W+Down30W	Up	15W	90	2700K	110°	1376lm	936lm	ON-OFF 1-10V DALI
	Down	30W	90	2700K	24°	2753lm	1818lm	
	Up	15W	90	2700K	110°	1376lm	936lm	ON-OFF 1-10V DALI
	Down	30W	90	2700K	36°	2753lm	1839lm	
	Up	15W	90	3000K	110°	1449lm	985lm	ON-OFF 1-10V DALI
	Down	30W	90	3000K	24°	2898lm	1914lm	
	Up	15W	90	3000K	110°	1449lm	985lm	ON-OFF 1-10V DALI
	Down	30W	90	3000K	36°	2898lm	1936lm	
	Up	15W	90	3500K	110°	1536lm	1044lm	ON-OFF 1-10V DALI
	Down	30W	90	3500K	24°	3072lm	2029lm	
	Up	15W	90	3500K	110°	1536lm	1044lm	ON-OFF 1-10V DALI
	Down	30W	90	3500K	24°	3072lm	2052lm	
	Up	15W	90	4000K	110°	1565lm	1064lm	ON-OFF 1-10V DALI
	Down	30W	90	4000K	24°	3129lm	2067lm	
	Up	15W	90	4000K	110°	1565lm	1064lm	ON-OFF 1-10V DALI
	Down	30W	90	4000K	36°	3129lm	2091lm	

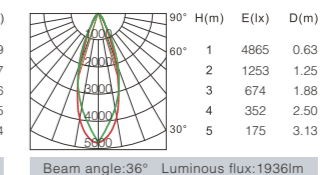
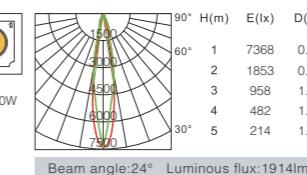
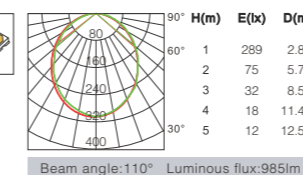

GLOW MODE



Down

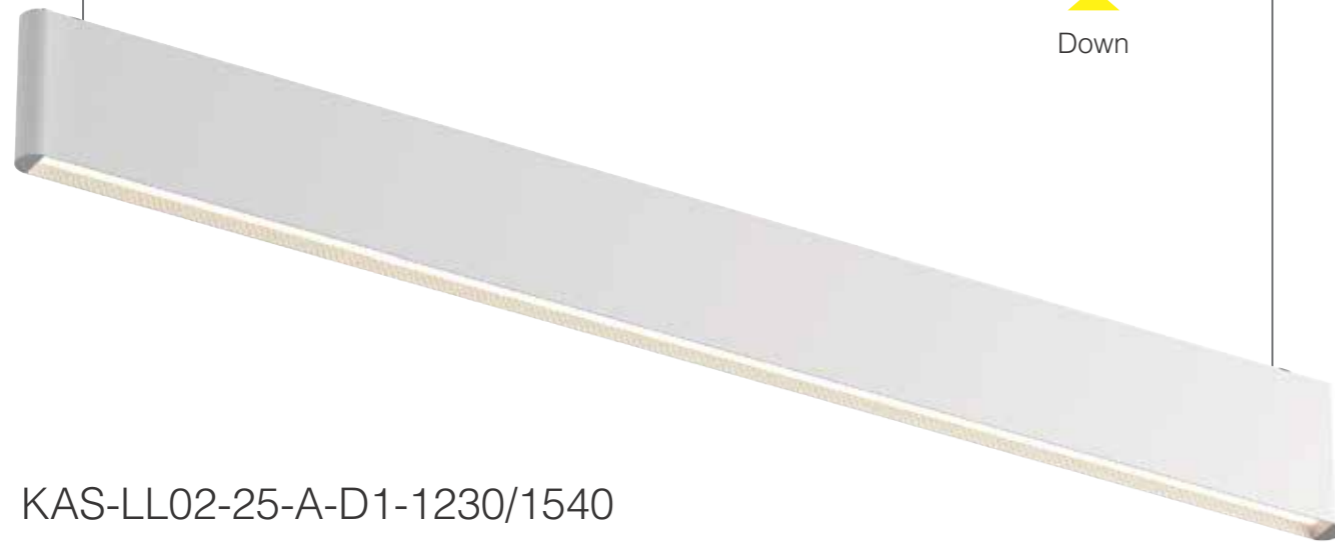

KAS-LL02-25-A-D1-1230/1540



Front detail

Back detail

Glow effect



KAS-LL02-25-A-D1-1230/1540

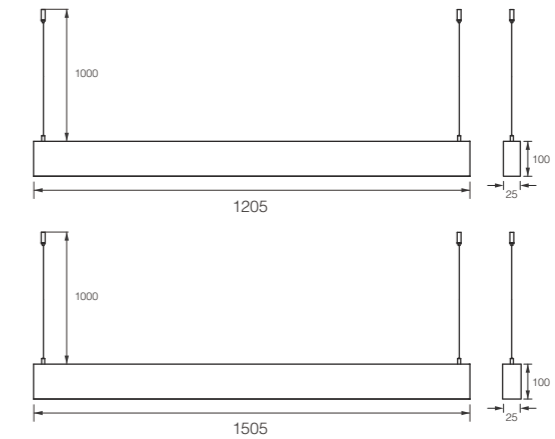

Model	Power	CRI	CCT	Beam Angle	LED Output	System Output	Dimming Type
KAS-LL02-25-A-D1-1230	36W	90	2700K	110°	3534lm	2417lm	ON-OFF 1-10V DALI
	36W	90	3000K	110°	3720lm	2544lm	
	36W	90	3500K	110°	3943lm	2697lm	
	36W	90	4000K	110°	4018lm	2748lm	
KAS-LL02-25-A-D1-1540	42W	90	2700K	110°	3933lm	3122lm	ON-OFF 1-10V DALI
	42W	90	3000K	110°	4140lm	3286lm	
	42W	90	3500K	110°	4388lm	3483lm	
	42W	90	4000K	110°	4471lm	3549lm	

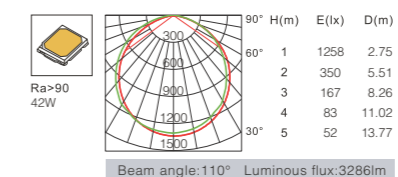
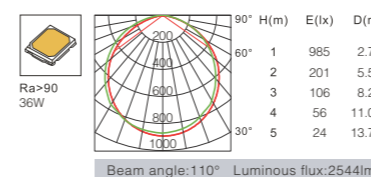



GLOW MODE



Down

KAS-LL02-34-T-RA1-0620/1240



Front detail



Back detail

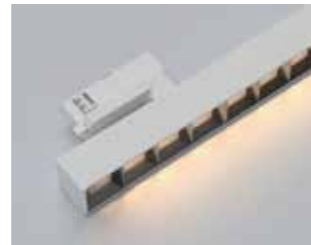

Glow effect



KAS-LL02-34-T-RA1-0620/1240

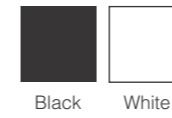
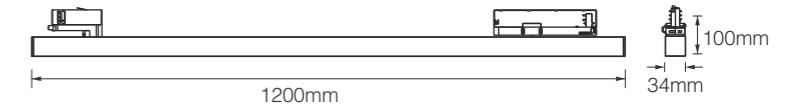
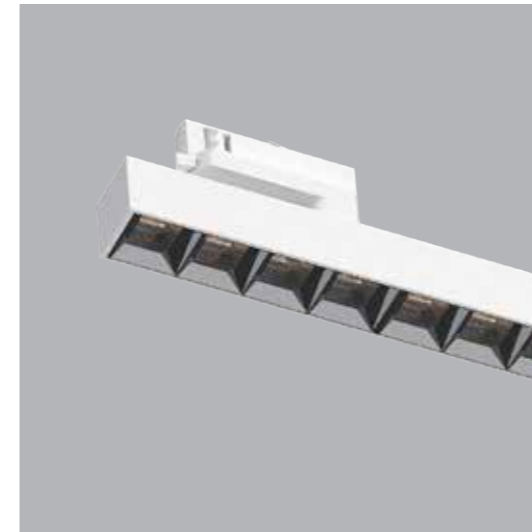

Model	Power	CRI	CCT	Beam Angle	LED Output	System Output	Dimming Type
 KAS-LL02-34-T-RA1-0620	20W	90	2700K 2700K	30°*75° 45°*75°	1966lm 1966lm	1249lm 1309lm	ON-OFF 1-10V DALI
	20W	90	3000K 3000K	30°*75° 45°*75°	2070lm 2070lm	1315lm 1378lm	
	20W	90	3500K 3500K	30°*75° 45°*75°	2194lm 2194lm	1394lm 1460lm	
	20W	90	4000K 4000K	30°*75° 45°*75°	2236lm 2236lm	1420lm 1488lm	
 KAS-LL02-34-T-RA1-1240	40W	90	2700K 2700K	30°*75° 45°*75°	3743lm 3743lm	2550lm 2620lm	ON-OFF 1-10V DALI
	40W	90	3000K 3000K	30°*75° 45°*75°	3940lm 3940lm	2685lm 2758lm	
	40W	90	3500K 3500K	30°*75° 45°*75°	4176lm 4176lm	2846lm 2923lm	
	40W	90	4000K 4000K	30°*75° 45°*75°	4255lm 4255lm	2899lm 2978lm	

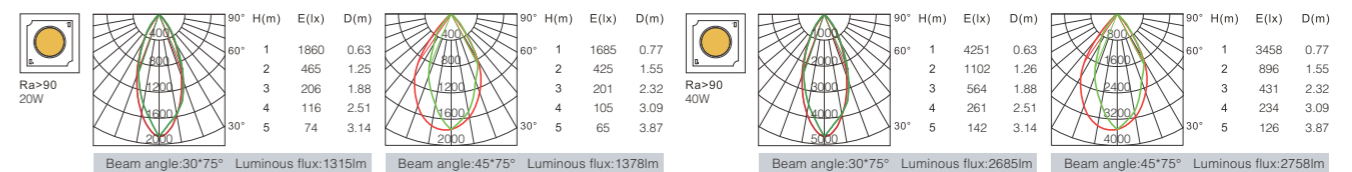

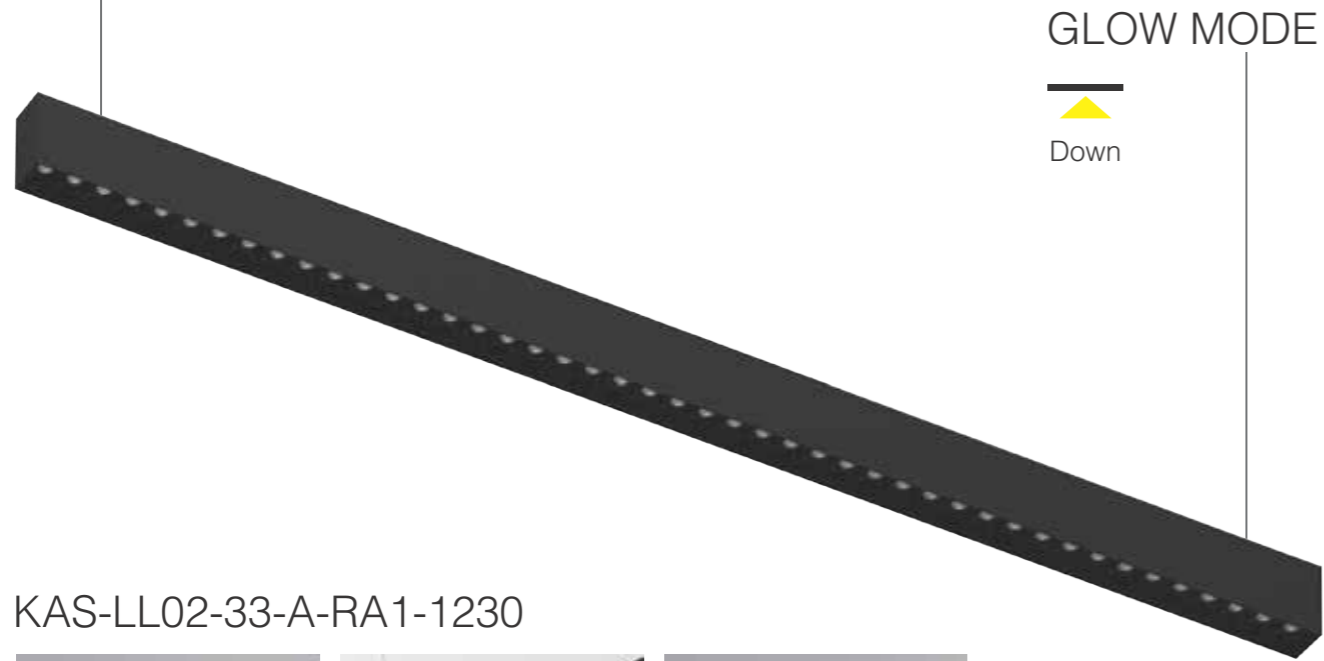

KAS-LL02-33-A-RA1-1230



Front detail



Back detail



Glow effect



KAS-LL02-33-A-RA1-1230

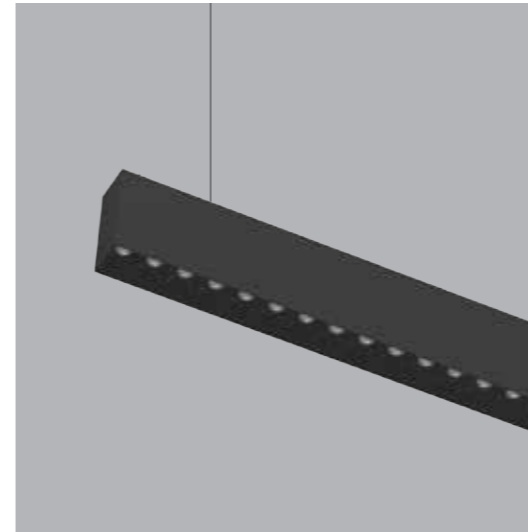

Model	Power	CRI	CCT	Beam Angle	LED Output	System Output	Dimming Type
KAS-LL02-33-A-RA1-1230	36W	90	2700K	15°	2593lm	1721lm	ON-OFF
	36W	90	2700K	30°	2593lm	1771lm	1-10V
	36W	90	2700K	45°	2593lm	1817lm	DALI
	36W	90	3000K	15°	2730lm	1812lm	ON-OFF
	36W	90	3000K	30°	2730lm	1864lm	1-10V
	36W	90	3000K	45°	2730lm	1913lm	DALI
	36W	90	3500K	15°	2894lm	1920lm	ON-OFF
	36W	90	3500K	30°	2894lm	1976lm	1-10V
	36W	90	3500K	45°	2894lm	2028lm	DALI
	36W	90	4000K	15°	2948lm	1967lm	ON-OFF
	36W	90	4000K	30°	2948lm	2013lm	1-10V
	36W	90	4000K	45°	2948lm	2066lm	DALI

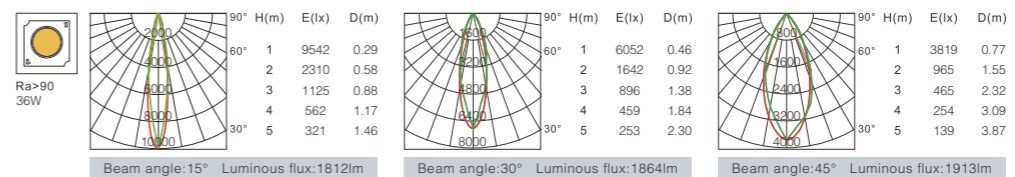

KAS-LL02-33-A-RA1-1536

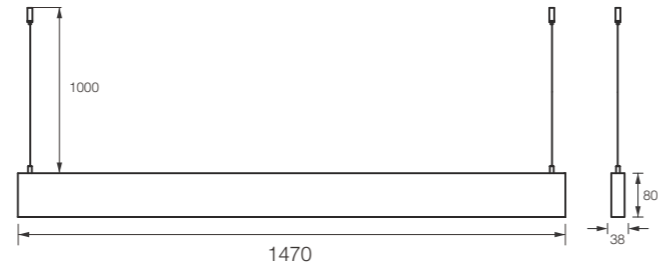
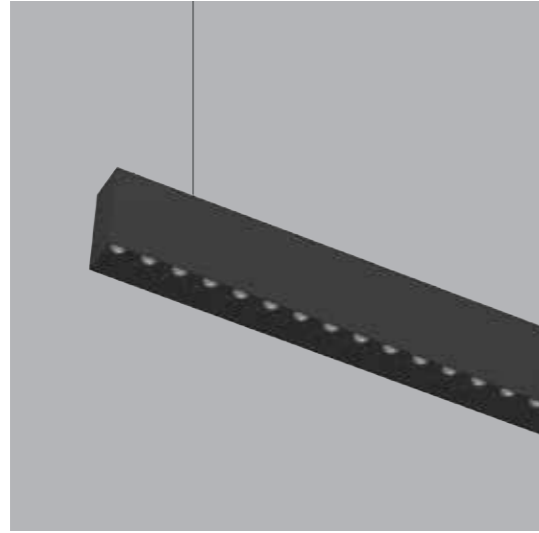

Model	Power	CRI	CCT	Beam Angle	LED Output	System Output	Dimming Type
KAS-LL02-33-A-RA1-1536	42W	90	2700K	15°	3952lm	2582lm	ON-OFF
	42W	90	2700K	30°	3952lm	2659lm	1-10V
	42W	90	2700K	45°	3952lm	2724lm	DALI
	42W	90	3000K	15°	4162lm	2718lm	ON-OFF
	42W	90	3000K	30°	4162lm	2799lm	1-10V
	42W	90	3000K	45°	4162lm	2867lm	DALI
	42W	90	3500K	15°	4368lm	2881lm	ON-OFF
	42W	90	3500K	30°	4368lm	2967lm	1-10V
	42W	90	3500K	45°	4368lm	3039lm	DALI
	42W	90	4000K	15°	4493lm	2935lm	ON-OFF
	42W	90	4000K	30°	4493lm	3023lm	1-10V
	42W	90	4000K	45°	4493lm	3096lm	DALI

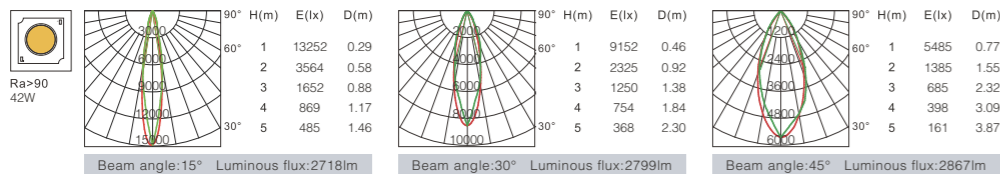



GLOW MODE



KAS-LL02-33-A-D1-1230/1536



Front detail

Back detail

Glow effect



KAS-LL02-33-A-D1-1230/1536

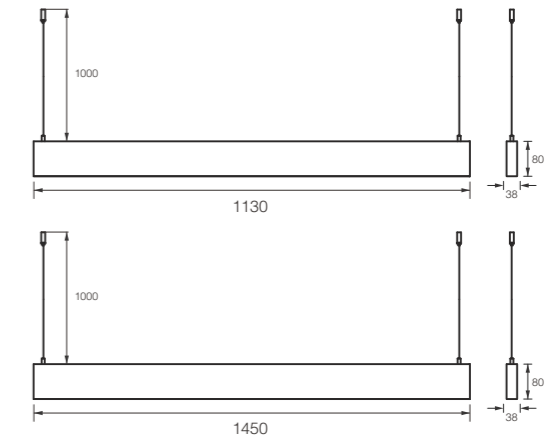
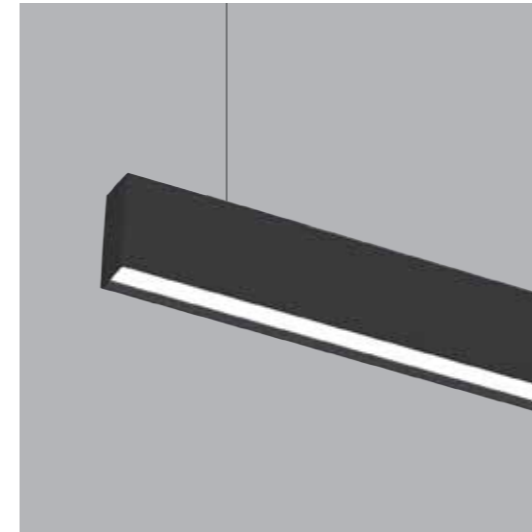

Model	Power	CRI	CCT	Beam Angle	LED Output	System Output	Dimming Type
KAS-LL02-33-A-D1-1230	36W	90	2700K	110°	3532lm	2334lm	ON-OFF 1-10V DALI
	36W	90	3000K	110°	3718lm	2457lm	
	36W	90	3500K	110°	3904lm	2604lm	
	36W	90	4000K	110°	4015lm	2653lm	
KAS-LL02-33-A-D1-1536	42W	90	2700K	110°	3922lm	2578lm	ON-OFF 1-10V DALI
	42W	90	3000K	110°	4129lm	2714lm	
	42W	90	3500K	110°	4335lm	2877lm	
	42W	90	4000K	110°	4459lm	2931lm	

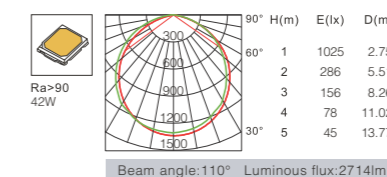
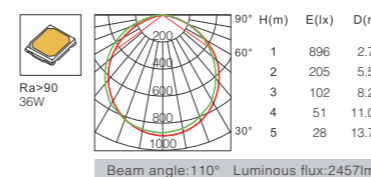

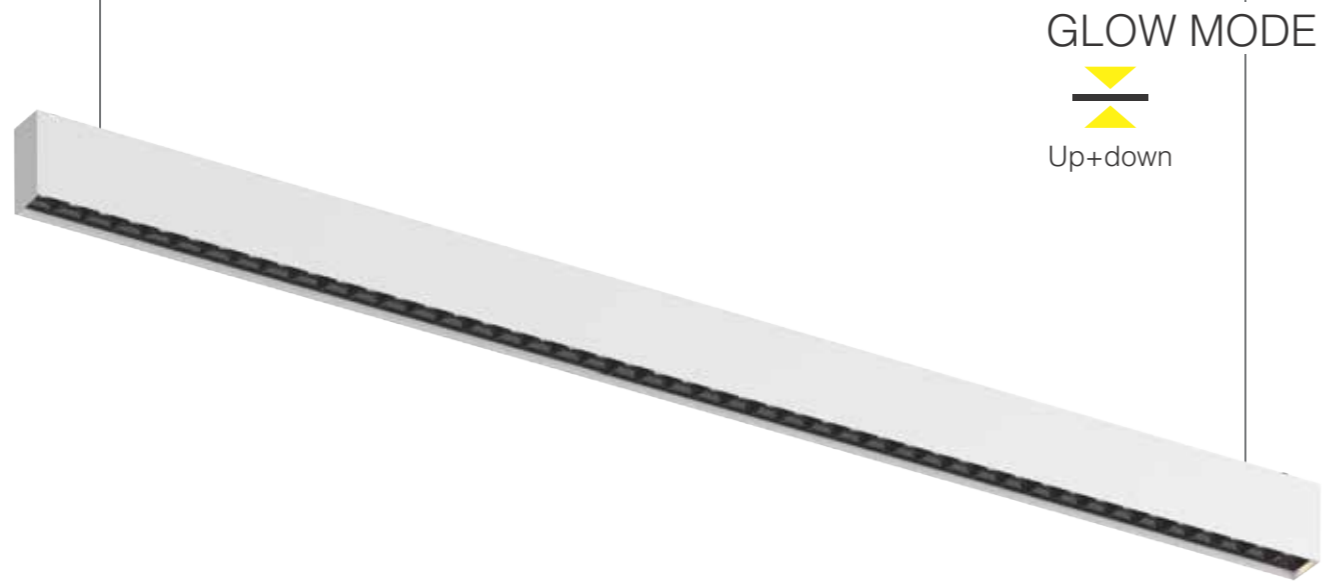

KAS-LL02-33-A-RA2-1230



Front detail



Back detail



Glow effect



KAS-LL02-33-A-RA2-1230



Model	Power	CRI	CCT	Beam Angle	LED Output	System Output	Dimming Type
KAS-LL02-33-A-RA1-1230 Up18W+Down36W	18W+36W	90	2700K	15°	1769+3513lm	1169+2324lm	ON-OFF
	18W+36W	90	2700K	30°	1769+3513lm	1220+2390lm	1-10V
	18W+36W	90	2700K	45°	1769+3513lm	1271+2466lm	DALI
	18W+36W	90	3000K	15°	1863+3698lm	1231+2447lm	ON-OFF
	18W+36W	90	3000K	30°	1863+3698lm	1285+2516lm	1-10V
	18W+36W	90	3000K	45°	1863+3698lm	1338+2596lm	DALI
	18W+36W	90	3500K	15°	1975+3920lm	1305+2594lm	ON-OFF
	18W+36W	90	3500K	30°	1975+3920lm	1362+2667lm	1-10V
	18W+36W	90	3500K	45°	1975+3920lm	1418+2752lm	DALI
	18W+36W	90	4000K	15°	2012+3994lm	1329+2643lm	ON-OFF
	18W+36W	90	4000K	30°	2012+3994lm	1389+2717lm	1-10V
	18W+36W	90	4000K	45°	2012+3994lm	1445+2804lm	DALI

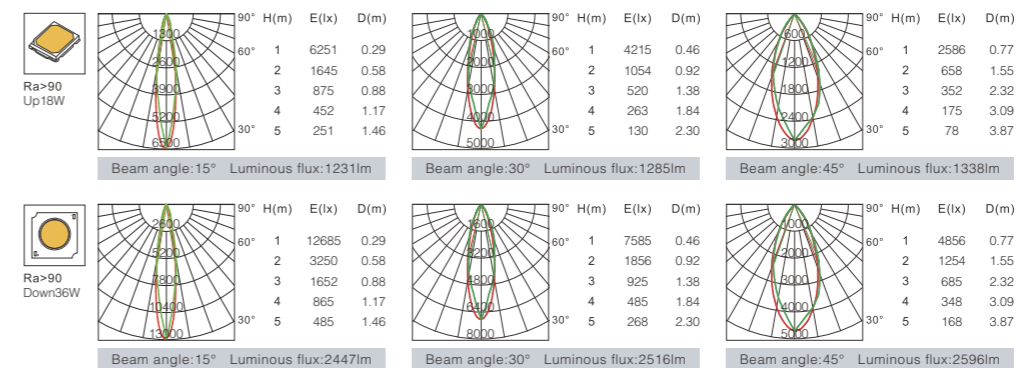

KAS-LL02-33-A-RA2-1560

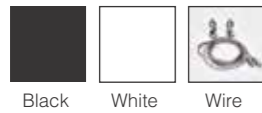

Model	Power	CRI	CCT	Beam Angle	LED Output	System Output	Dimming Type
KAS-LL02-33-A-RA1-1536 Up20W+Down42W	20W+42W	90	2700K	15°	1971+3948lm	1258+2603lm	ON-OFF
	20W+42W	90	2700K	30°	1971+3948lm	1326+2674lm	1-10V
	20W+42W	90	2700K	45°	1971+3948lm	1363+2751lm	DALI
	20W+42W	90	3000K	15°	2075+4156lm	1324+2741lm	ON-OFF
	20W+42W	90	3000K	30°	2075+4156lm	1396+2815lm	1-10V
	20W+42W	90	3000K	45°	2075+4156lm	1435+2896lm	DALI
	20W+42W	90	3500K	15°	2199+4405lm	1403+2905lm	ON-OFF
	20W+42W	90	3500K	30°	2199+4405lm	1479+2984lm	1-10V
	20W+42W	90	3500K	45°	2199+4405lm	1521+3069lm	DALI
	20W+42W	90	4000K	15°	2241+4488lm	1430+2960lm	ON-OFF
	20W+42W	90	4000K	30°	2241+4488lm	1507+3040lm	1-10V
	20W+42W	90	4000K	45°	2241+4488lm	1550+3128lm	DALI

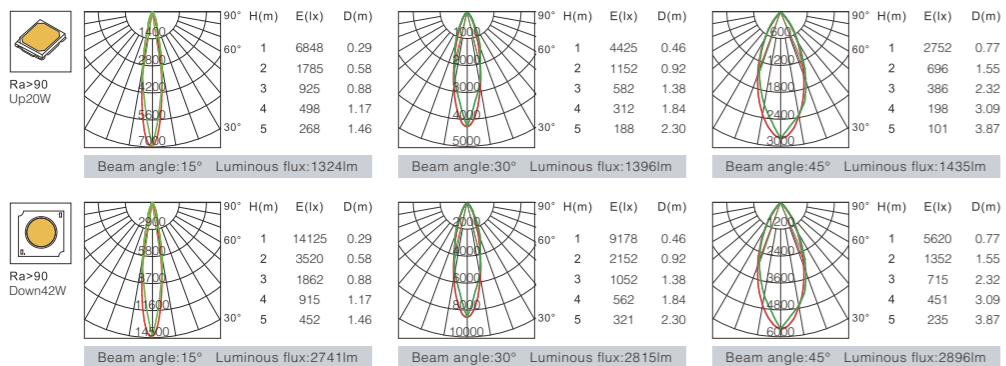

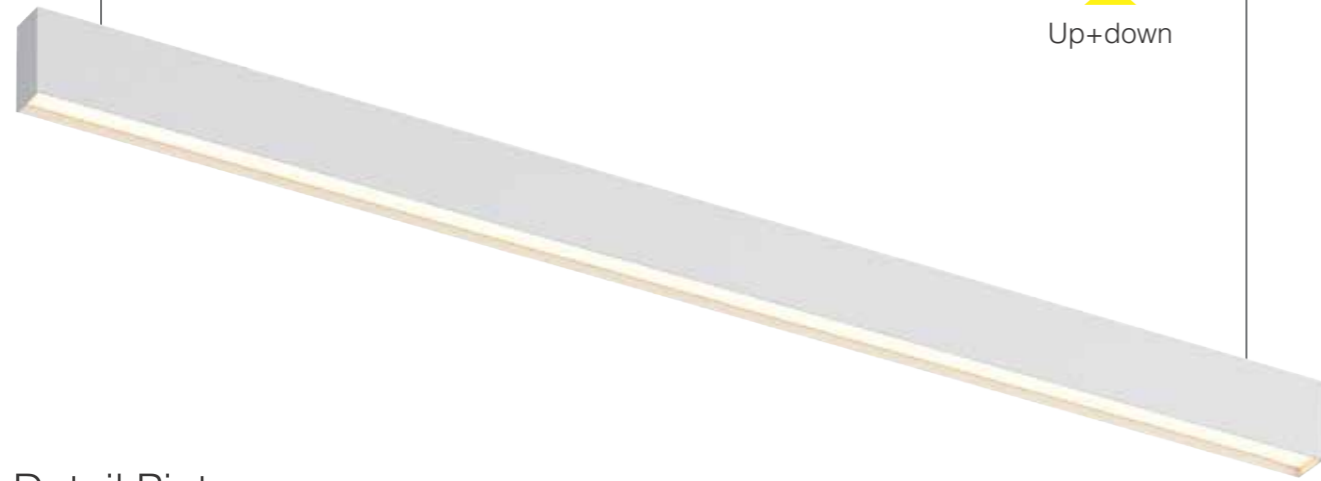

GLOW MODE

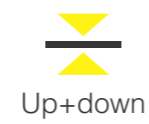

Detail Pictures



Front detail

Back detail

Glow effect



KAS-LL02-33-A-D2-1230/1536

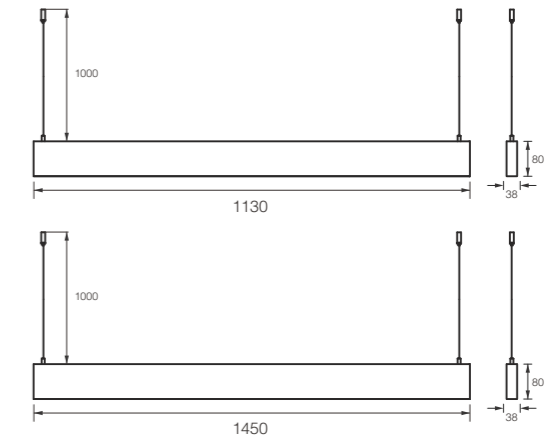
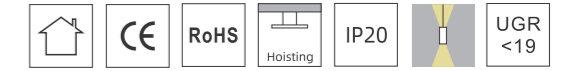

Model	Power	CRI	CCT	Beam Angle	LED Output	System Output	Dimming Type
KAS-LL02-33-A-D2-1230 Up18W+Down36W	18W+36W	90	2700K	110°	1770+3540lm	1179+2294lm	ON-OFF 1-10V DALI
	20W+42W	90	2700K	110°	1966+3933lm	1284+2644lm	
KAS-LL02-33-A-D2-1536 Up20W+Down42W	18W+36W	90	3000K	110°	1863+3726lm	1241+2415lm	ON-OFF 1-10V DALI
	20W+42W	90	3000K	110°	2070+4140lm	1352+2783lm	
	18W+36W	90	3500K	110°	1975+3949lm	1315+2560lm	ON-OFF 1-10V DALI
	20W+42W	90	3500K	110°	2194+4388lm	1433+2950lm	
	18W+36W	90	4000K	110°	2012+4024lm	1340+2608lm	ON-OFF 1-10V DALI
	20W+42W	90	4000K	110°	2236+4471lm	1460+3005lm	

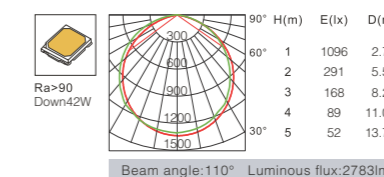
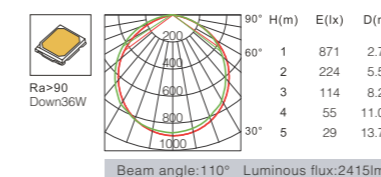
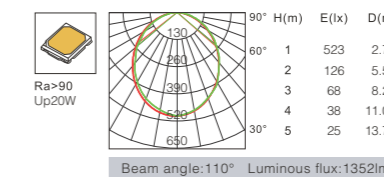
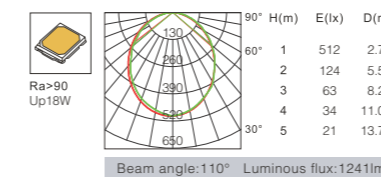



GLOW MODE



Detail Pictures



Front detail

Back detail

Glow effect



KAS-LL02-33-A-RB1-1230

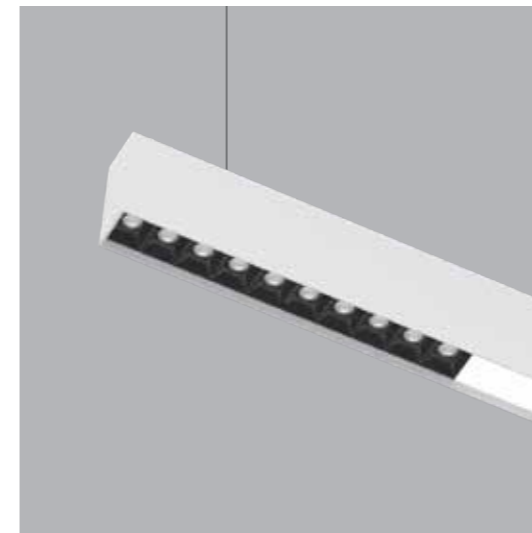

Model	Power	CRI	CCT	Beam Angle	LED Output	System Output	Dimming Type
KAS-LL02-33-A-RB1-1230	36W	90	2700K	15°	3540lm	2294lm	ON-OFF
	36W	90	2700K	30°	3540lm	2340lm	1-10V
	36W	90	2700K	45°	3540lm	2385lm	DALI
	36W	90	3000K	15°	3726lm	2415lm	ON-OFF
	36W	90	3000K	30°	3726lm	2464lm	1-10V
	36W	90	3000K	45°	3726lm	2512lm	DALI
	36W	90	3500K	15°	3949lm	2560lm	ON-OFF
	36W	90	3500K	30°	3949lm	2612lm	1-10V
	36W	90	3500K	45°	3949lm	2663lm	DALI
	36W	90	4000K	15°	4024lm	2608lm	ON-OFF
	36W	90	4000K	30°	4024lm	2662lm	1-10V
	36W	90	4000K	45°	4024lm	2713lm	DALI

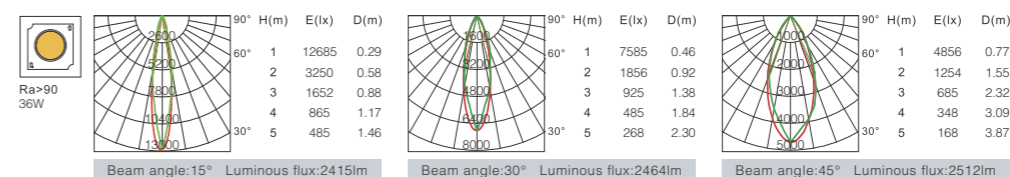

KAS-LL02-33-A-RB1-1536

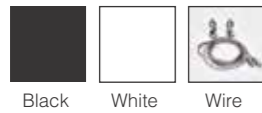
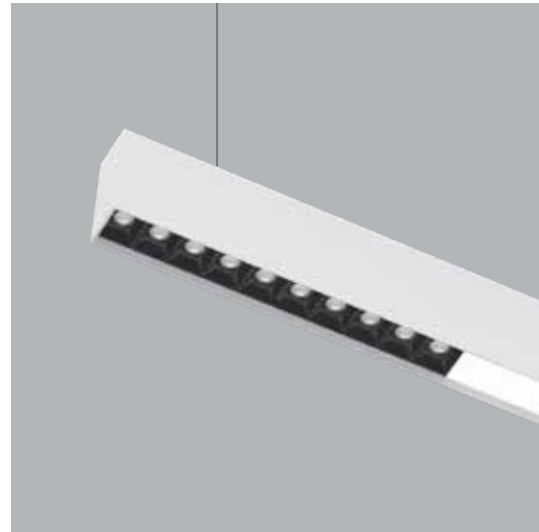

Model	Power	CRI	CCT	Beam Angle	LED Output	System Output	Dimming Type
KAS-LL02-33-A-RB1-1536	42W	90	2700K	15°	3948lm	2603lm	ON-OFF
	42W	90	2700K	30°	3948lm	2675lm	1-10V
	42W	90	2700K	45°	3948lm	2751lm	DALI
	42W	90	3000K	15°	4156lm	2741lm	ON-OFF
	42W	90	3000K	30°	4156lm	2815lm	1-10V
	42W	90	3000K	45°	4156lm	2896lm	DALI
	42W	90	3500K	15°	4405lm	2905lm	ON-OFF
	42W	90	3500K	30°	4405lm	2984lm	1-10V
	42W	90	3500K	45°	4405lm	3069lm	DALI
	42W	90	4000K	15°	4488lm	2960lm	ON-OFF
	42W	90	4000K	30°	4488lm	3040lm	1-10V
	42W	90	4000K	45°	4488lm	3128lm	DALI

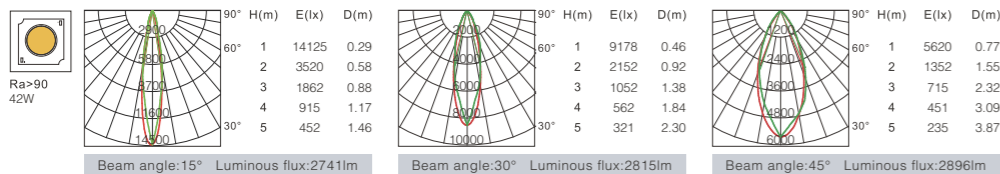

GLOW MODE



Detail Pictures



Front detail

Back detail

Glow effect



KAS-LL02-33-A-RB2-1230

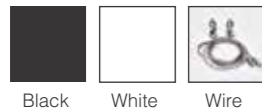
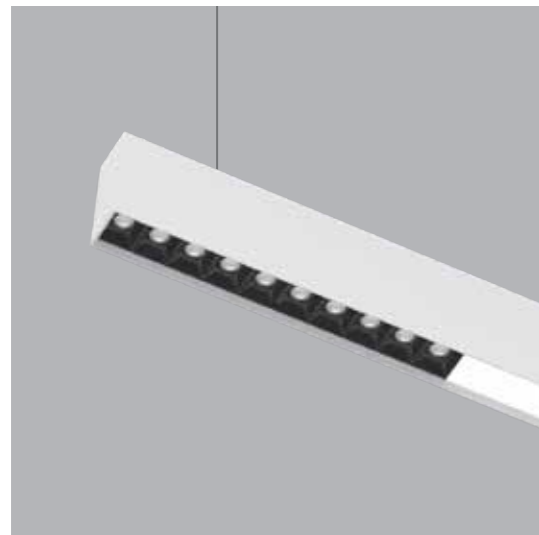

Model	Power	CRI	CCT	Beam Angle	LED Output	System Output	Dimming Type
KAS-LL02-33-A-RB2-1230 Up15W+Down36W	15W+36W	90	2700K	15°	1377+3540lm	866+2269lm	ON-OFF
	15W+36W	90	2700K	30°	1377+3540lm	916+2316lm	1-10V
	15W+36W	90	2700K	45°	1377+3540lm	938+2366lm	DALI
	15W+36W	90	3000K	15°	1450+3726lm	912+2389lm	ON-OFF
	15W+36W	90	3000K	30°	1450+3726lm	964+2438lm	1-10V
	15W+36W	90	3000K	45°	1450+3726lm	987+2491lm	DALI
	15W+36W	90	3500K	15°	1537+3949lm	966+2532lm	ON-OFF
	15W+36W	90	3500K	30°	1537+3949lm	1021+2584lm	1-10V
	15W+36W	90	3500K	45°	1537+3949lm	1046+2640lm	DALI
	15W+36W	90	4000K	15°	1566+4024lm	985+2580lm	ON-OFF
	15W+36W	90	4000K	30°	1566+4024lm	1041+2633lm	1-10V
	15W+36W	90	4000K	45°	1566+4024lm	1066+2690lm	DALI

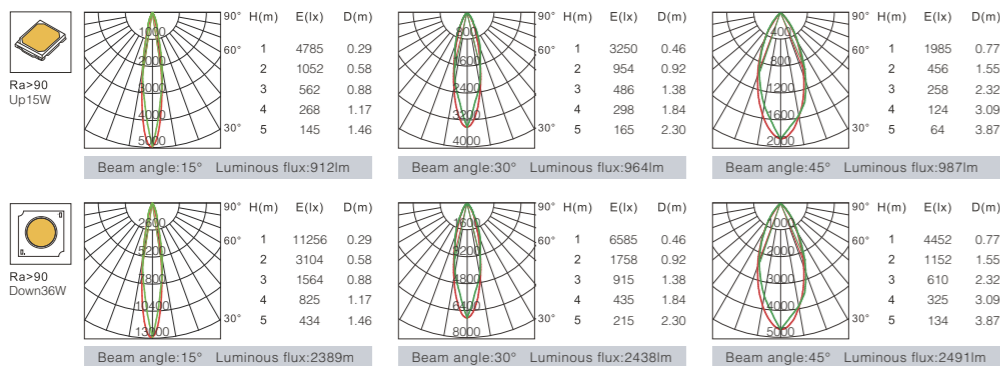

KAS-LL02-33-A-RB2-1536

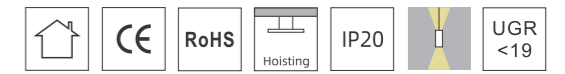
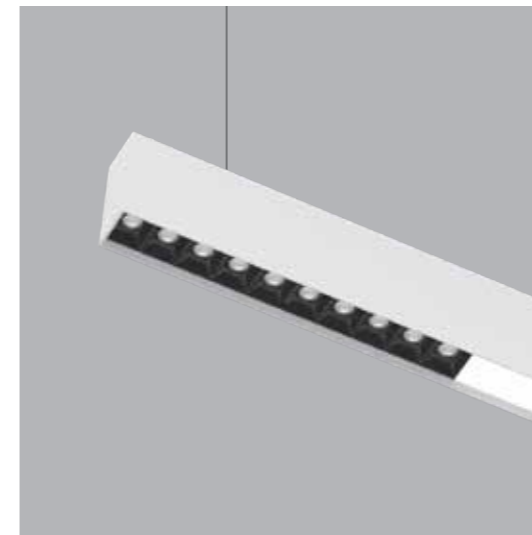

Model	Power	CRI	CCT	Beam Angle	LED Output	System Output	Dimming Type
KAS-LL02-33-A-RB2-1230 Up18W+Down42W	18W+42W	90	2700K	15°	1770+3933lm	1146+2579lm	ON-OFF
	18W+42W	90	2700K	30°	1770+3933lm	1179+2644lm	1-10V
	18W+42W	90	2700K	45°	1770+3933lm	1249+2694lm	DALI
	18W+42W	90	3000K	15°	1863+4140lm	1207+2715lm	ON-OFF
	18W+42W	90	3000K	30°	1863+4140lm	1241+2783lm	1-10V
	18W+42W	90	3000K	45°	1863+4140lm	1315+2836lm	DALI
	18W+42W	90	3500K	15°	1975+4388lm	1279+2878lm	ON-OFF
	18W+42W	90	3500K	30°	1975+4388lm	1315+2950lm	1-10V
	18W+42W	90	3500K	45°	1975+4388lm	1394+3006lm	DALI
	18W+42W	90	4000K	15°	2012+4471lm	1303+2932lm	ON-OFF
	18W+42W	90	4000K	30°	2012+4471lm	1340+3005lm	1-10V
	18W+42W	90	4000K	45°	2012+4471lm	1420+3062lm	DALI

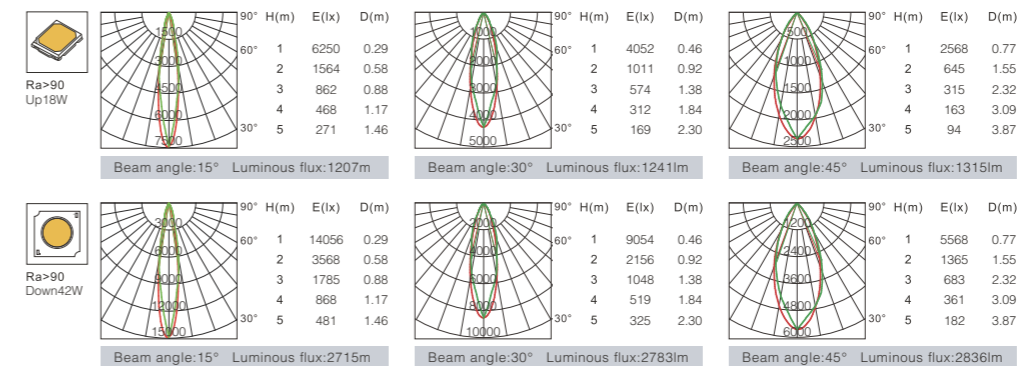

GLOW MODE



Detail Pictures



Front detail



Back detail



Glow effect



KAS-LL02-33-C-D-0620/1230

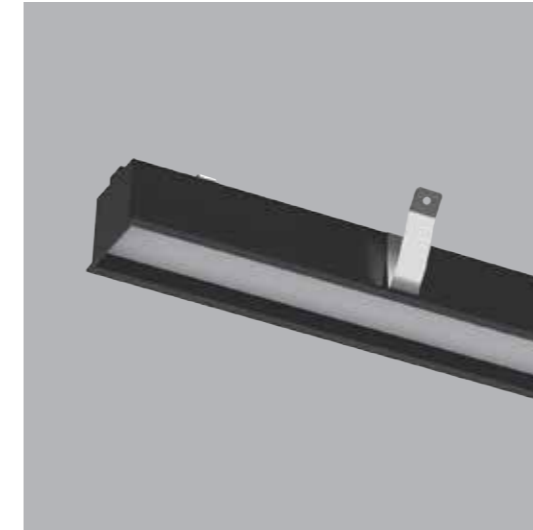
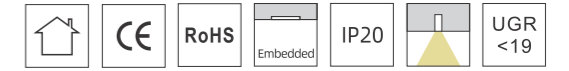

cutout (mm): 640*42mm



cutout (mm): 1118*42mm

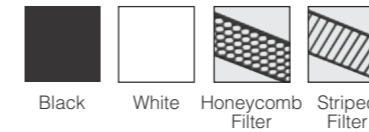

Model	Power	CRI	CCT	Beam Angle	LED Output	System Output	Dimming Type
 KAS-LL02-33-C-D-0620	20W	90	2700K	110°	1966lm	1247lm	ON-OFF 1-10V DALI
	20W	90	3000K	110°	2070lm	1313lm	
	20W	90	3500K	110°	2194lm	1392lm	
	20W	90	4000K	110°	2236lm	1418lm	
 KAS-LL02-33-C-D-1230	36W	90	2700K	110°	3540lm	2325lm	ON-OFF 1-10V DALI
	36W	90	3000K	110°	3726lm	2447lm	
	36W	90	3500K	110°	3949lm	2594lm	
	36W	90	4000K	110°	4024lm	2643lm	

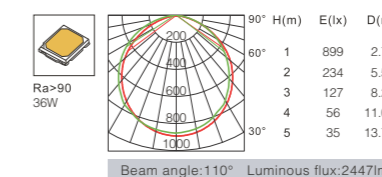
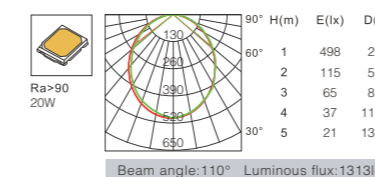

GLOW MODE

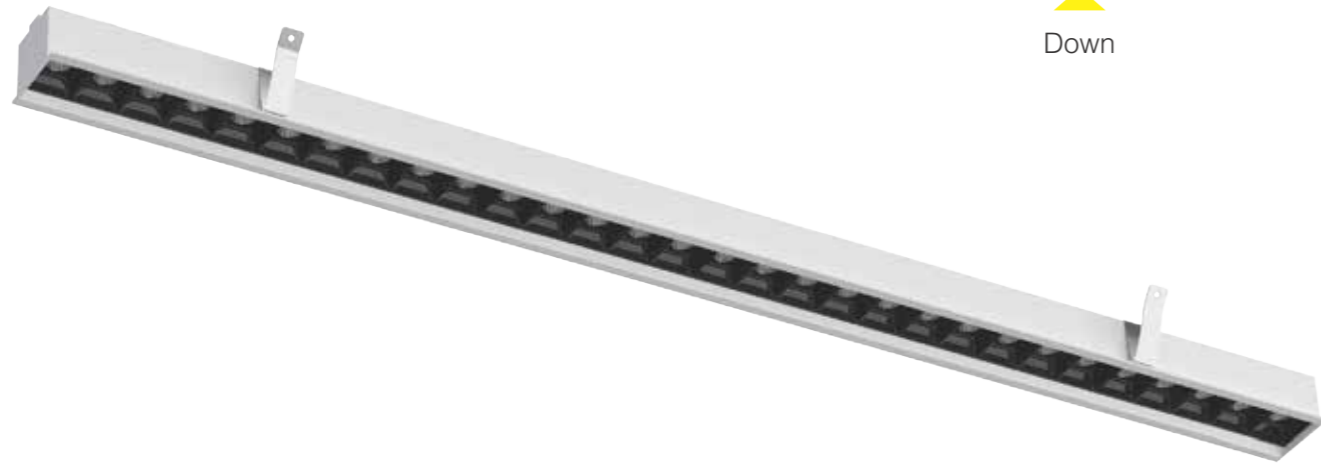

Detail Pictures



Front detail

Back detail

Glow effect



KAS-LL02-33-C-RA-0620

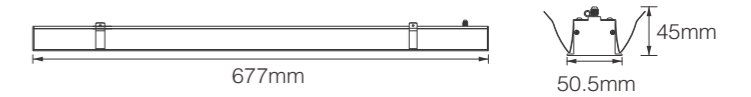
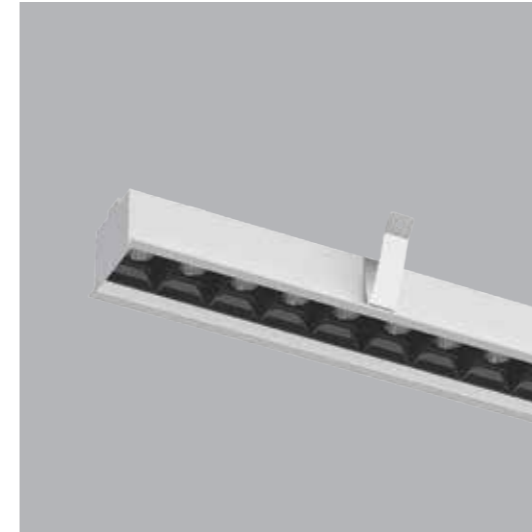
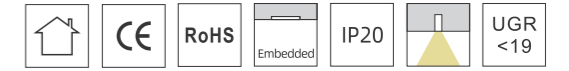

cutout (mm): 667*42mm



Model	Power	CRI	CCT	Beam Angle	LED Output	System Output	Dimming Type
KAS-LL02-33-C-RA-0620	20W	90	2700K	24°	1966lm	1193lm	ON-OFF
	20W	90	2700K	30°	1966lm	1217lm	1-10V
	20W	90	2700K	45°	1966lm	1258lm	DALI
	20W	90	3000K	24°	2070lm	1256lm	ON-OFF
	20W	90	3000K	30°	2070lm	1281lm	1-10V
	20W	90	3000K	45°	2070lm	1324lm	DALI
	20W	90	3500K	24°	2194lm	1331lm	ON-OFF
	20W	90	3500K	30°	2194lm	1358lm	1-10V
	20W	90	3500K	45°	2194lm	1403lm	DALI
	20W	90	4000K	24°	2236lm	1356lm	ON-OFF
	20W	90	4000K	30°	2236lm	1383lm	1-10V
	20W	90	4000K	45°	2236lm	1430lm	DALI

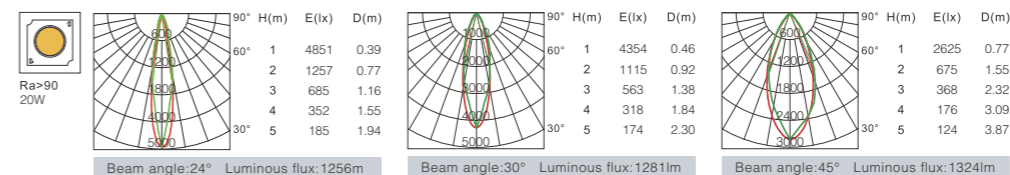

KAS-LL02-33-C-RA-1230

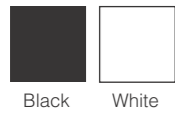
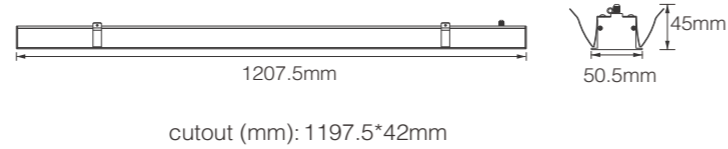
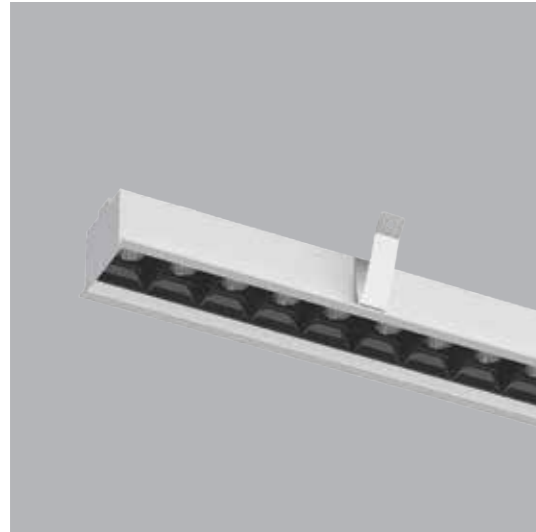

Model	Power	CRI	CCT	Beam Angle	LED Output	System Output	Dimming Type
KAS-LL02-33-C-RA-1230	36W	90	2700K	24°	3540lm	2254lm	ON-OFF
	36W	90	2700K	30°	3540lm	2292m	1-10V
	36W	90	2700K	45°	3540lm	2344lm	DALI
<hr/>							
	36W	90	3000K	24°	3726lm	2373lm	ON-OFF
	36W	90	3000K	30°	3726lm	2413lm	1-10V
	36W	90	3000K	45°	3726lm	2467lm	DALI
<hr/>							
	36W	90	3500K	24°	3949lm	2515lm	ON-OFF
	36W	90	3500K	30°	3949lm	2558lm	1-10V
	36W	90	3500K	45°	3949lm	2615lm	DALI
<hr/>							
	36W	90	4000K	24°	4024lm	2563lm	ON-OFF
	36W	90	4000K	30°	4024lm	2606lm	1-10V
	36W	90	4000K	45°	4024lm	2664lm	DALI

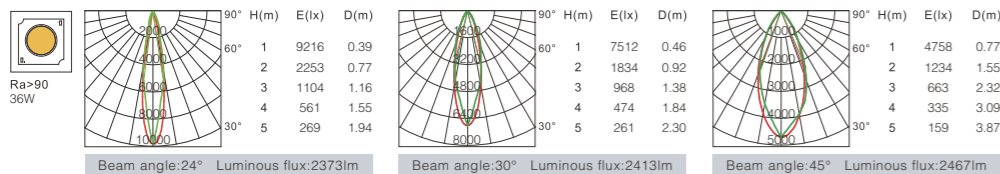

GLOW MODE

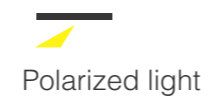

Detail Pictures



Front detail

Back detail

Polarized light



KAS-LL02-33-C-W-0620/1230

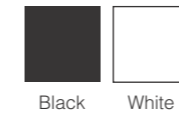
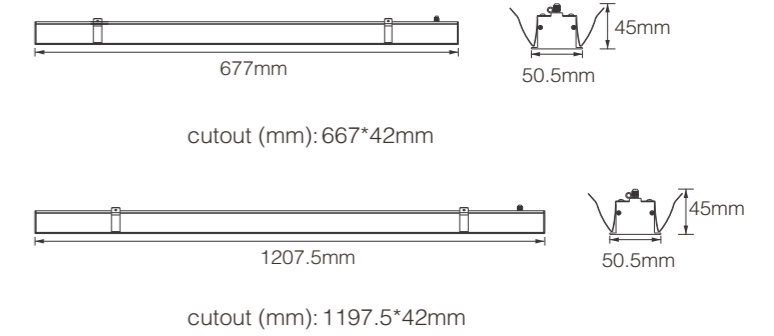
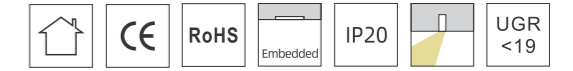

Model	Power	CRI	CCT	Beam Angle	LED Output	System Output	Dimming Type
KAS-LL02-33-C-W-0620	20W	90	2700K	wall washer	1881lm	1319lm	ON-OFF
	36W	90	2700K	wall washer	3386lm	2292lm	1-10V DALI
KAS-LL02-33-C-W-1230	20W	90	3000K	wall washer	1980lm	1389lm	ON-OFF
	36W	90	3000K	wall washer	3564lm	2413lm	1-10V DALI
KAS-LL02-33-C-W-1230	20W	90	3500K	wall washer	2099lm	1472lm	ON-OFF
	36W	90	3500K	wall washer	3778lm	2558lm	1-10V DALI
KAS-LL02-33-C-W-1230	20W	90	4000K	wall washer	2138lm	1500lm	ON-OFF
	36W	90	4000K	wall washer	3849lm	2606lm	1-10V DALI

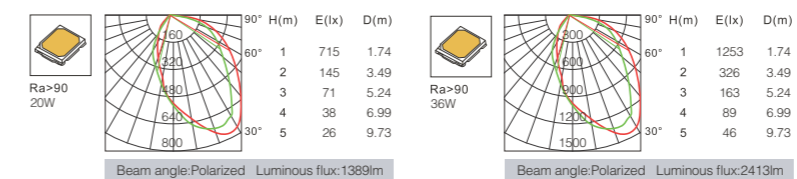

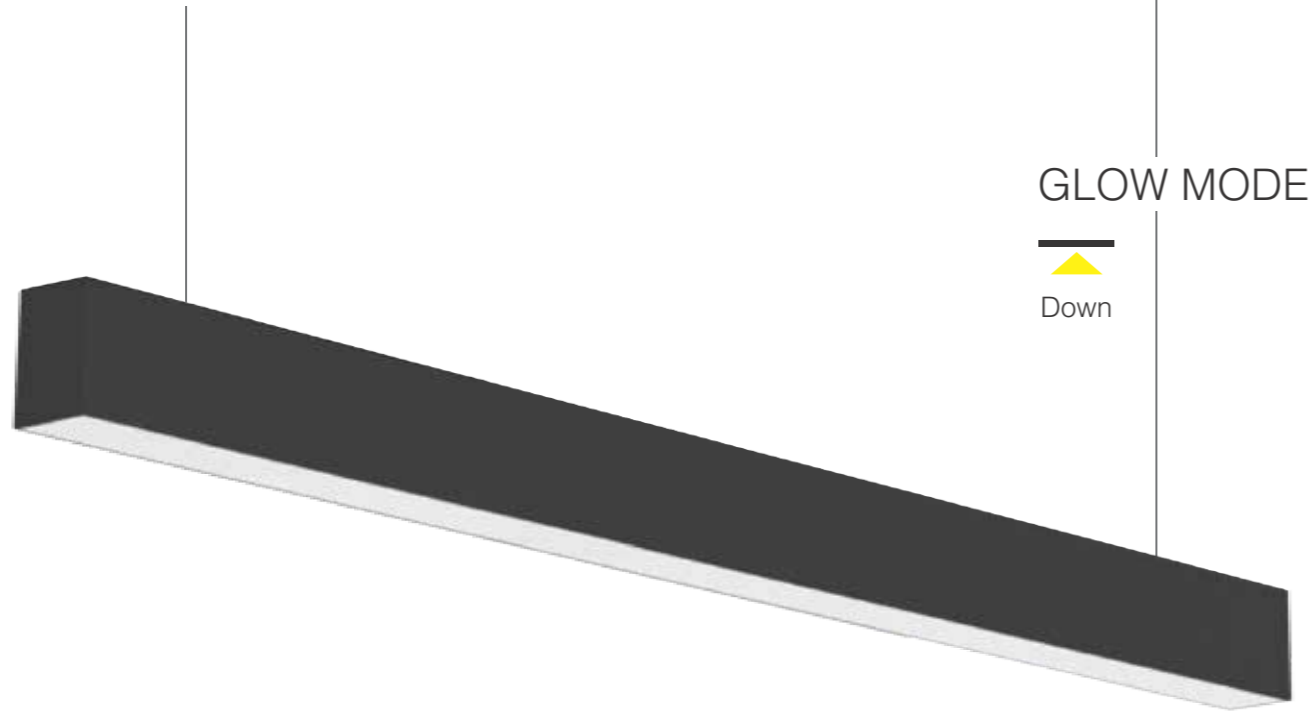

Detail Pictures



Front detail

Back detail

Glow effect



KAS-LL02-50-A-D1-1240

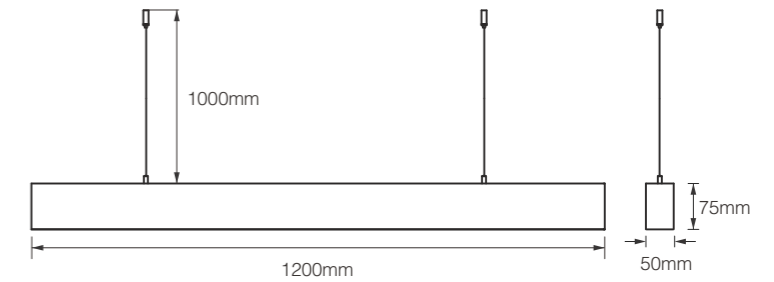
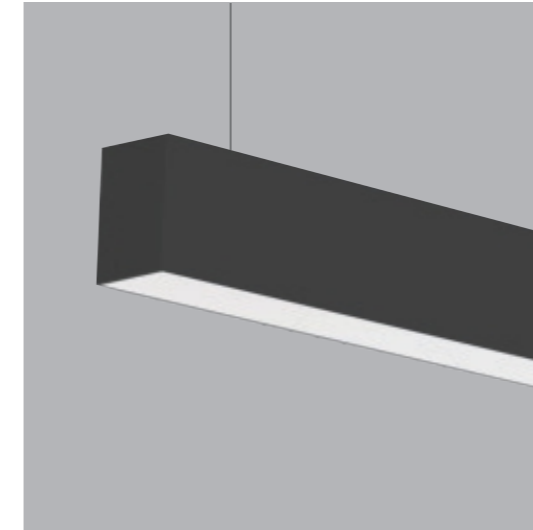
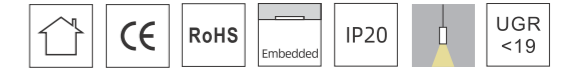

Model	Power	CRI	CCT	Beam Angle	LED Output	System Output	Dimming Type
KAS-LL02-50-A-D1-1240	40W	90	2700K	120°	3743lm	2575lm	ON-OFF 1-10V DALI
	40W	90	3000K	120°	3940lm	2711lm	ON-OFF 1-10V DALI
	40W	90	3500K	120°	4176lm	2874lm	ON-OFF 1-10V DALI
	40W	90	4000K	120°	4255lm	2928lm	ON-OFF 1-10V DALI

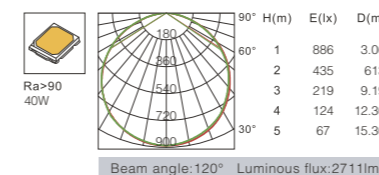

KAS-LL02-75-A-D1-1240

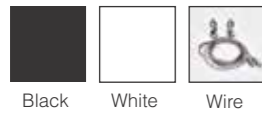
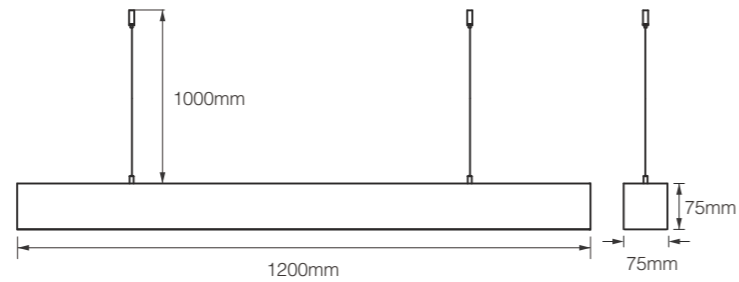
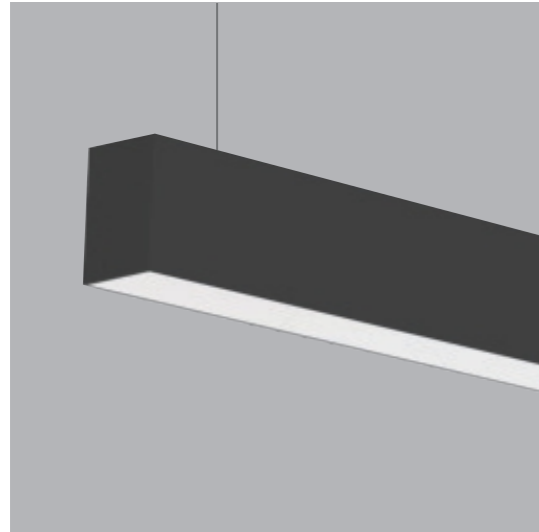

Model	Power	CRI	CCT	Beam Angle	LED Output	System Output	Dimming Type
KAS-LL02-75-A-D1-1240	40W	90	2700K	120°	3743lm	2675lm	ON-OFF 1-10V DALI
	40W	90	3000K	120°	3940lm	2816lm	ON-OFF 1-10V DALI
	40W	90	3500K	120°	4176lm	2985lm	ON-OFF 1-10V DALI
	40W	90	4000K	120°	4255lm	3041lm	ON-OFF 1-10V DALI

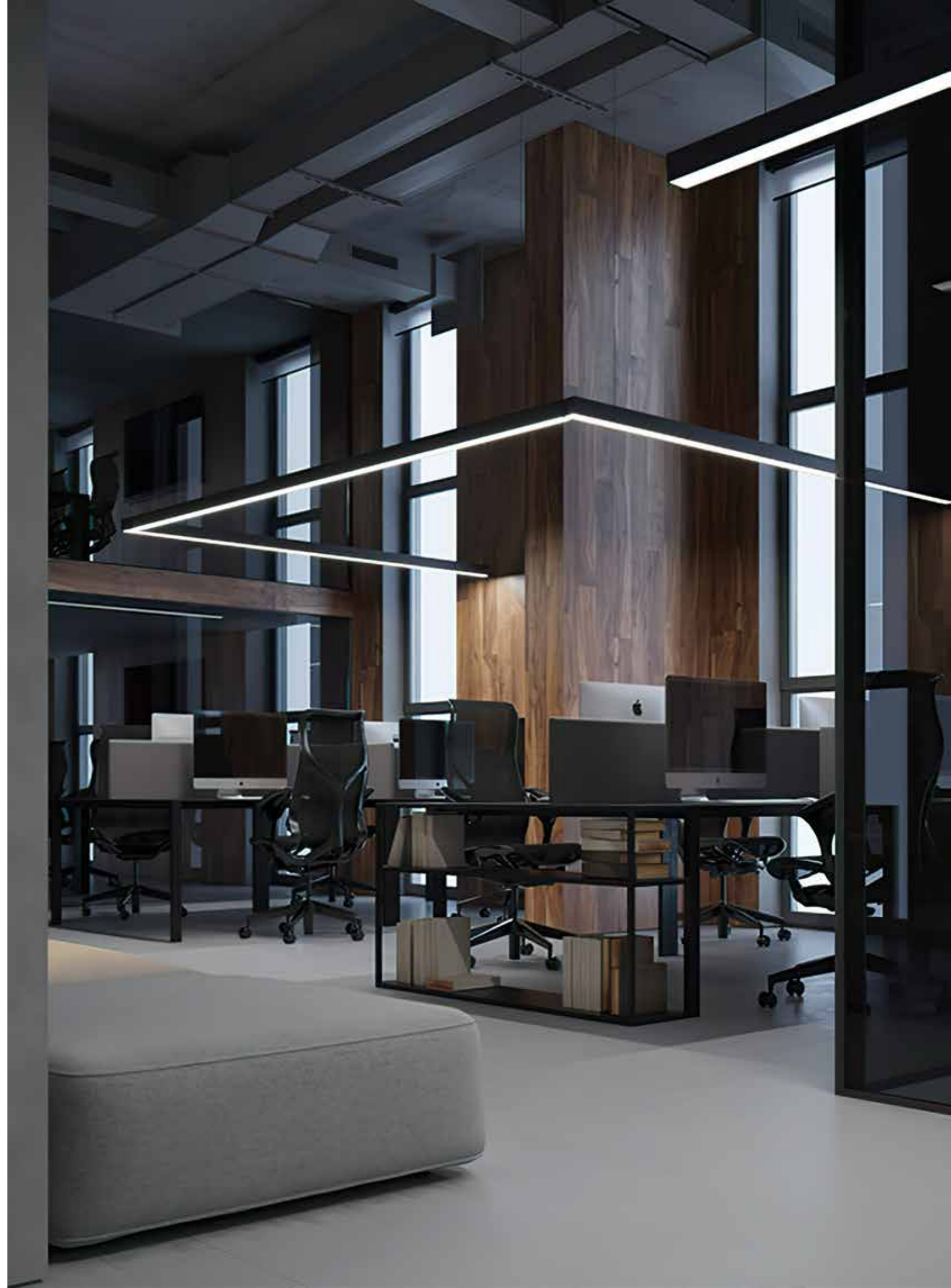
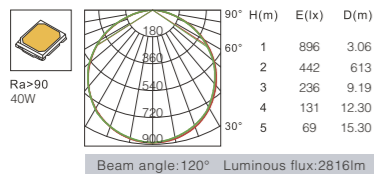

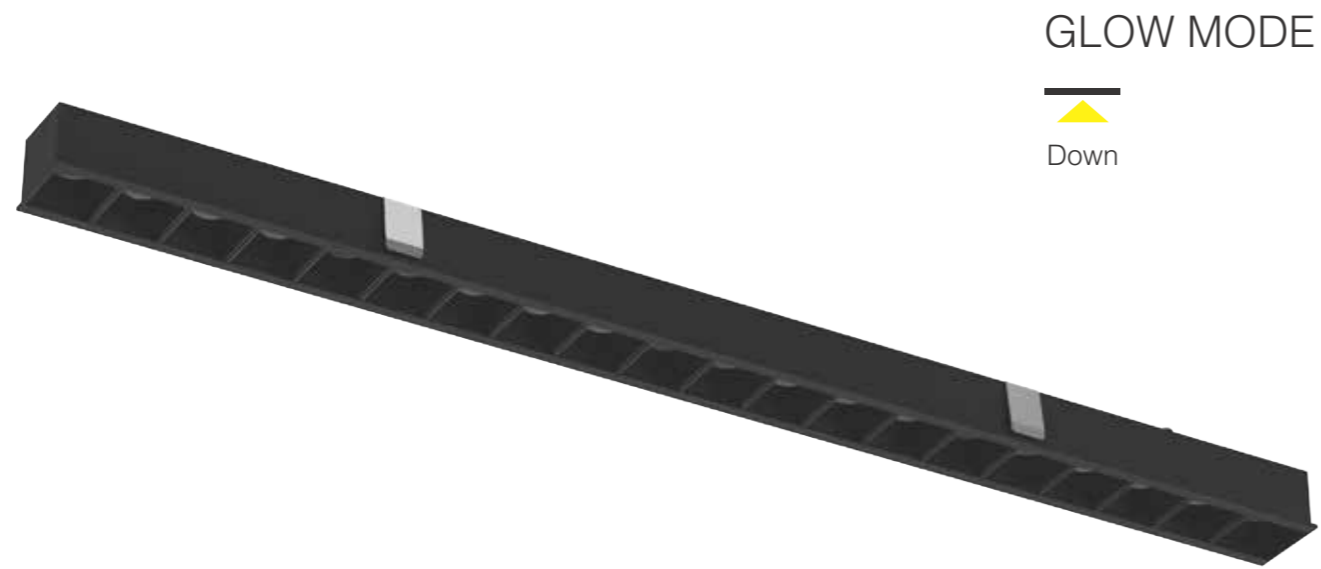

GLOW MODE



Down

Detail Pictures



Front detail



Back detail

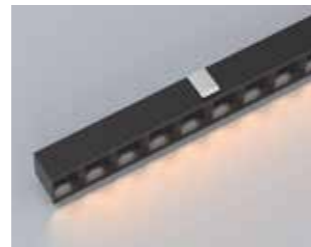

Glow effect



KAS-LL06-27-C-2506

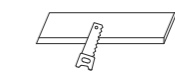
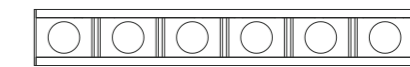
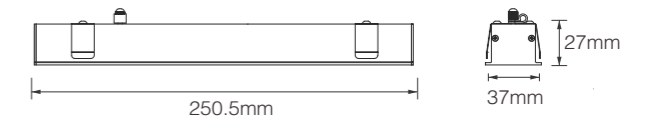
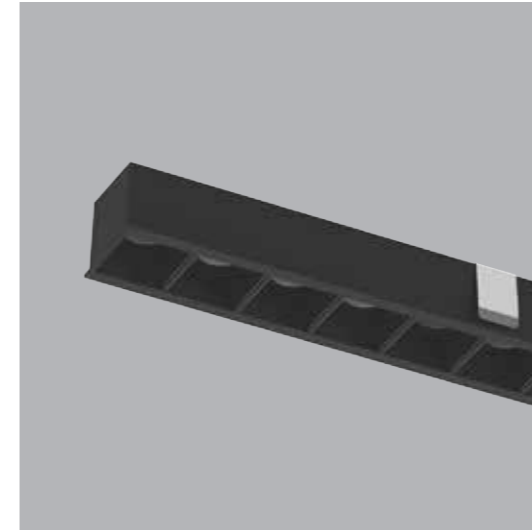
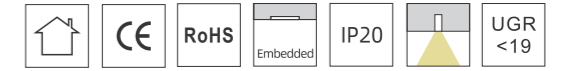

cutout (mm): 250.5*32mm



Black

Model	Power	CRI	CCT	Beam Angle	LED Output	System Output	Dimming Type
KAS-LL06-27-C-2506	6W	90	2700K	20*30°	590lm	367lm	ON-OFF 1-10V DALI
				20*40°	590lm	402lm	
	6W	90	3000K	20*30°	621lm	387lm	ON-OFF 1-10V DALI
				20*40°	621lm	423lm	
	6W	90	3500K	20*30°	658lm	410lm	ON-OFF 1-10V DALI
				20*40°	658lm	448lm	
	6W	90	4000K	20*30°	671lm	418lm	ON-OFF 1-10V DALI
				20*40°	671lm	457lm	

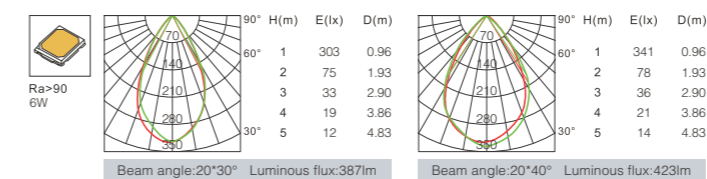

KAS-LL06-27-C-0512

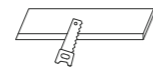
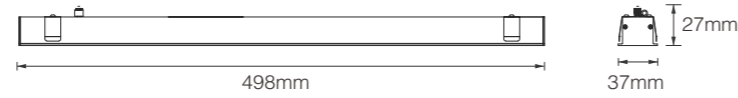
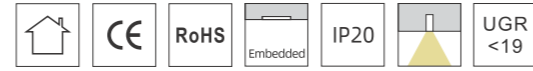
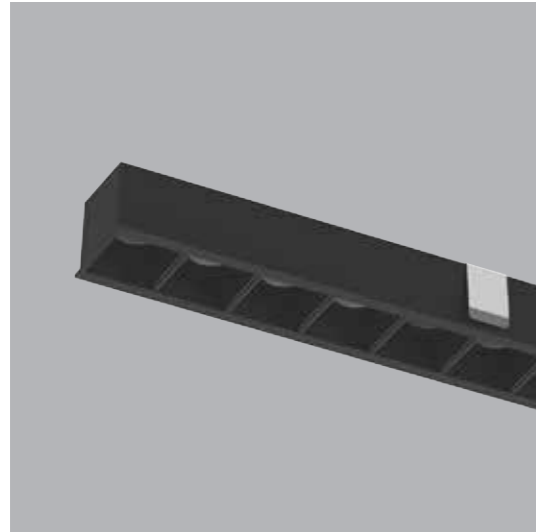

cutout (mm): 498*32mm



Black

Model	Power	CRI	CCT	Beam Angle	LED Output	System Output	Dimming Type
KAS-LL06-27-C-0512	12W	90	2700K	20*30°	1180lm	772lm	ON-OFF 1-10V DALI
				20*40°	1180lm	825lm	
	12W	90	3000K	20*30°	1242lm	813lm	ON-OFF 1-10V DALI
				20*40°	1242lm	869lm	
	12W	90	3500K	20*30°	1316lm	862lm	ON-OFF 1-10V DALI
				20*40°	1316lm	921lm	
	12W	90	4000K	20*30°	1341lm	878lm	ON-OFF 1-10V DALI
				20*40°	1341lm	938lm	

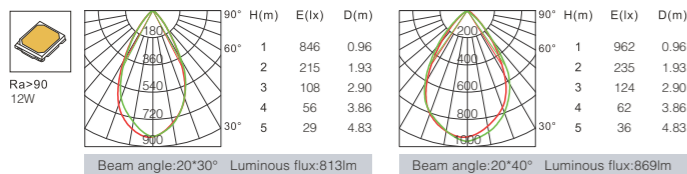

KAS-LL06-27-C-1024

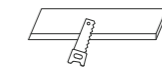
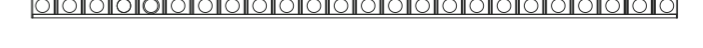
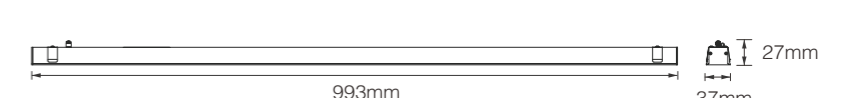
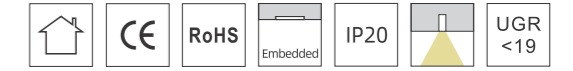
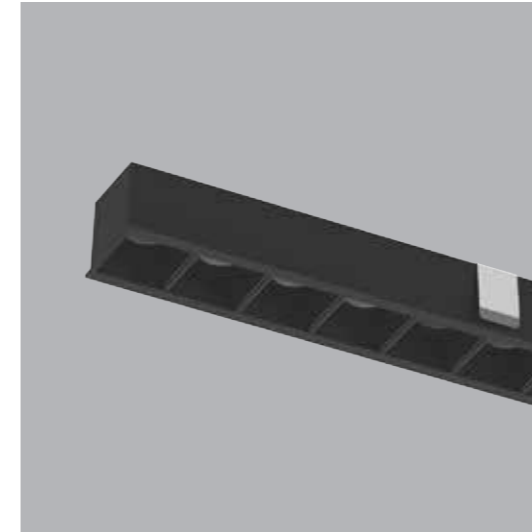

cutout (mm): 993*32mm



Black

Model	Power	CRI	CCT	Beam Angle	LED Output	System Output	Dimming Type
KAS-LL06-27-C-1024	24W	90	2700K	20*30°	2360lm	1598lm	ON-OFF 1-10V DALI
				20*40°	2360lm	1655lm	
	24W	90	3000K	20*30°	2484lm	1682lm	ON-OFF 1-10V DALI
				20*40°	2484lm	1742lm	
	24W	90	3500K	20*30°	2633lm	1783lm	ON-OFF 1-10V DALI
				20*40°	2633lm	1846lm	
	24W	90	4000K	20*30°	2682lm	1816lm	ON-OFF 1-10V DALI
				20*40°	2682lm	1881lm	

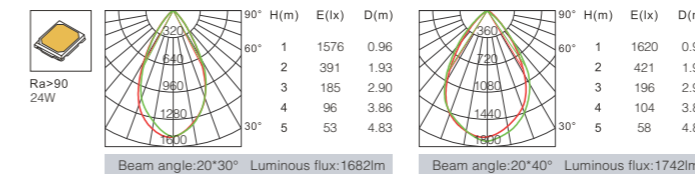

GLOW MODE

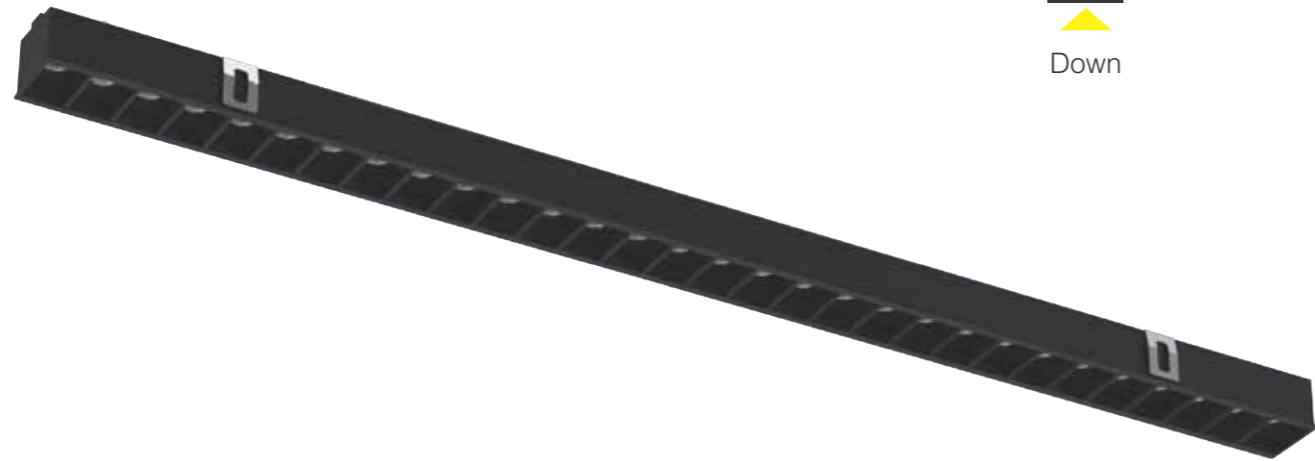

Detail Pictures



Front detail

Back detail

Glow effect



KAS-LL06-40-C-2506

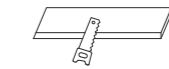
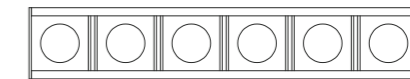
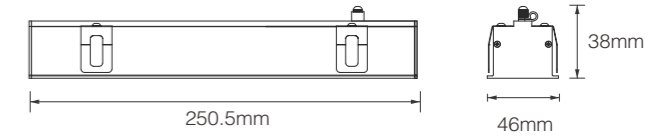
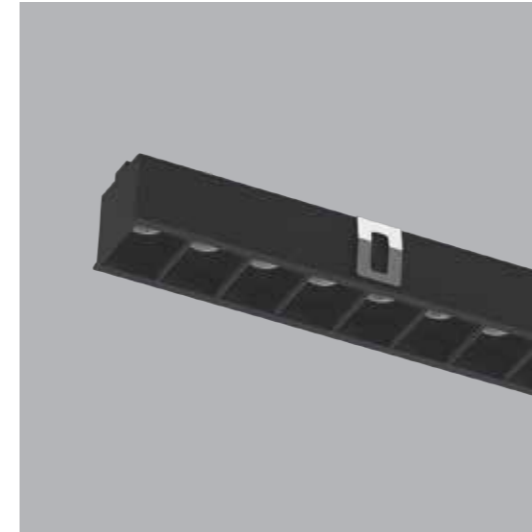
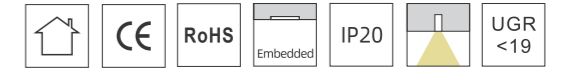

cutout (mm): 250.5*40mm



Black

Model	Power	CRI	CCT	Beam Angle	LED Output	System Output	Dimming Type
KAS-LL06-40-C-2506	6W	90	2700K	12*45°	590lm	325lm	ON-OFF 1-10V DALI
				15*30°	590lm	357lm	
				15*55°	590lm	393lm	
				60°	590lm	435lm	
KAS-LL06-40-C-2506	6W	90	3000K	12*45°	621lm	342lm	ON-OFF 1-10V DALI
				15*30°	621lm	376lm	
				15*55°	621lm	414lm	
				60°	621lm	458lm	
KAS-LL06-40-C-2506	6W	90	3500K	12*45°	658lm	362lm	ON-OFF 1-10V DALI
				15*30°	658lm	398lm	
				15*55°	658lm	438lm	
				60°	658lm	485lm	
KAS-LL06-40-C-2506	6W	90	4000K	12*45°	671lm	369lm	ON-OFF 1-10V DALI
				15*30°	671lm	406lm	
				15*55°	671lm	447lm	
				60°	671lm	495lm	

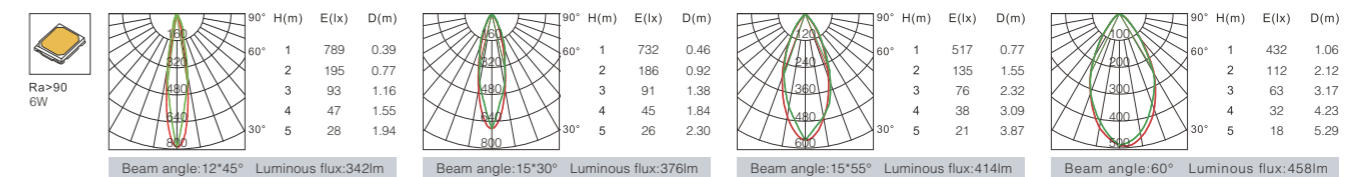

KAS-LL06-40-C-0512

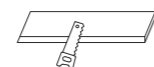
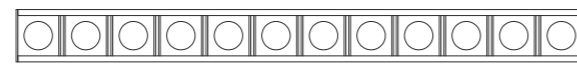
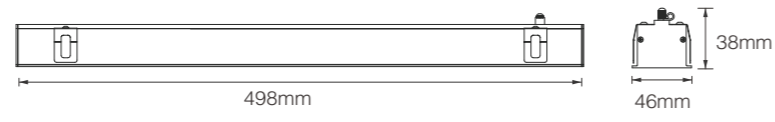
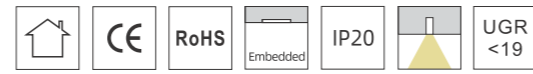
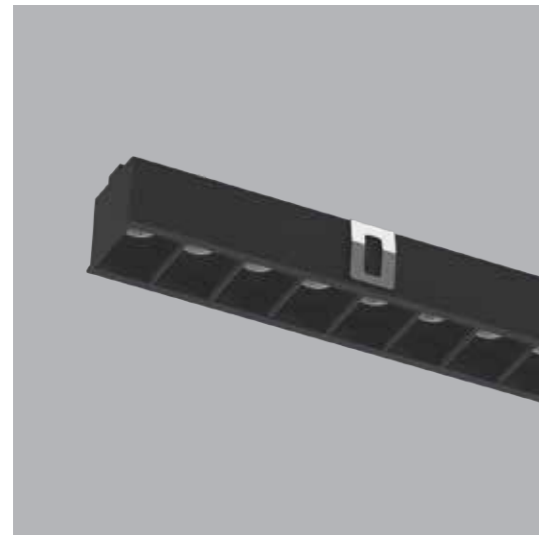

cutout (mm): 498*40mm



Black

Model	Power	CRI	CCT	Beam Angle	LED Output	System Output	Dimming Type
KAS-LL06-40-C-0512	12W	90	2700K	12*45°	1180lm	726lm	ON-OFF 1-10V DALI
				15*30°	1180lm	770lm	
				15*55°	1180lm	801lm	
				60°	1180lm	850lm	
12W	90	3000K	12*45°	1242lm	764lm	ON-OFF 1-10V DALI	
			15*30°	1242lm	811lm		
			15*55°	1242lm	843lm		
			60°	1242lm	895lm		
12W	90	3500K	12*45°	1316lm	810lm	ON-OFF 1-10V DALI	
			15*30°	1316lm	860lm		
			15*55°	1316lm	894lm		
			60°	1316lm	949lm		
12W	90	4000K	12*45°	1341lm	825lm	ON-OFF 1-10V DALI	
			15*30°	1341lm	876lm		
			15*55°	1341lm	910lm		
			60°	1341lm	967lm		

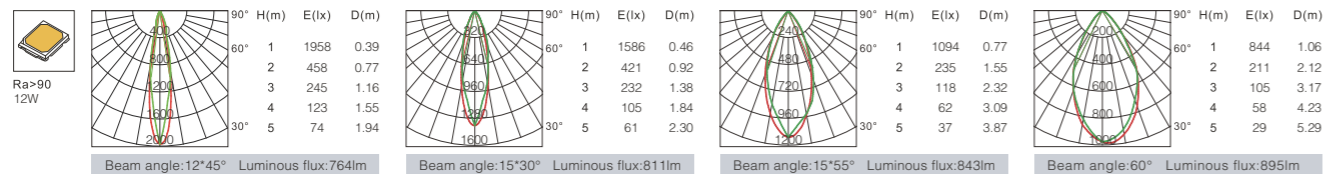

KAS-LL06-40-C-1024

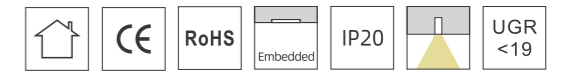
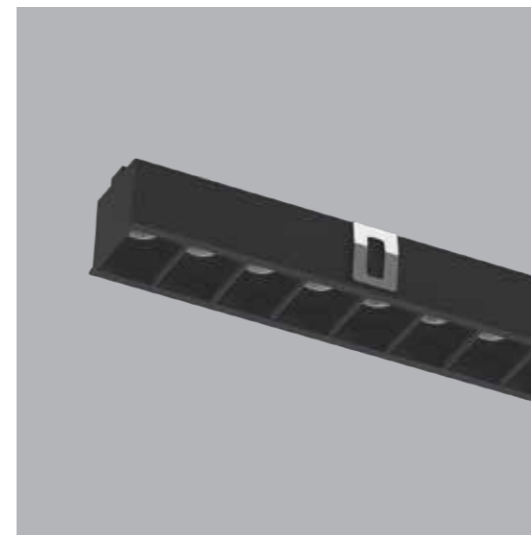

cutout (mm): 993*40mm



Black

Model	Power	CRI	CCT	Beam Angle	LED Output	System Output	Dimming Type
KAS-LL06-40-C-1024	24W	90	2700K	12*45°	2360lm	1544lm	ON-OFF 1-10V DALI
				15*30°	2360lm	1575lm	
				15*55°	2360lm	1670lm	
				60°	2360lm	1702lm	
24W	90	3000K	12*45°	2484lm	1625lm	ON-OFF 1-10V DALI	
			15*30°	2484lm	1658m		
			15*55°	2484lm	1758lm		
			60°	2484lm	1792lm		
24W	90	3500K	12*45°	2633lm	1722lm	ON-OFF 1-10V DALI	
			15*30°	2633lm	1757lm		
			15*55°	2633lm	1863lm		
			60°	2633lm	1899lm		
24W	90	4000K	12*45°	2682lm	1755lm	ON-OFF 1-10V DALI	
			15*30°	2682lm	1790lm		
			15*55°	2682lm	1863lm		
			60°	2682lm	1935lm		

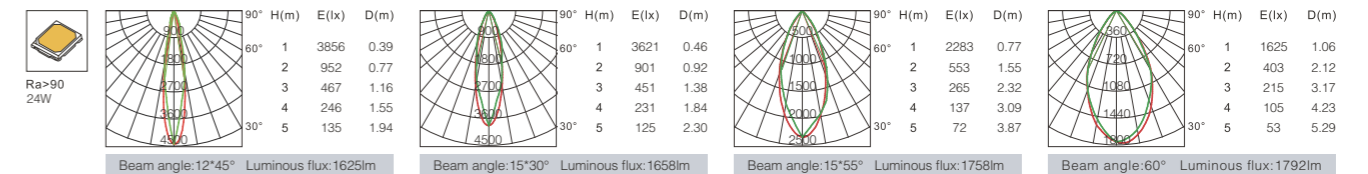

GLOW MODE



Down



Detail Pictures



Front detail

Back detail

Glow effect



KAS-LL02-62-A-D1-0620

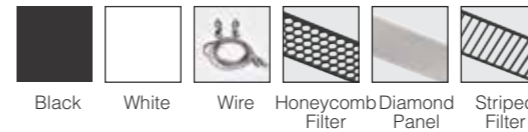
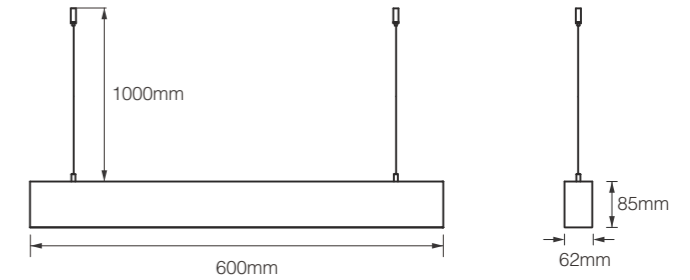
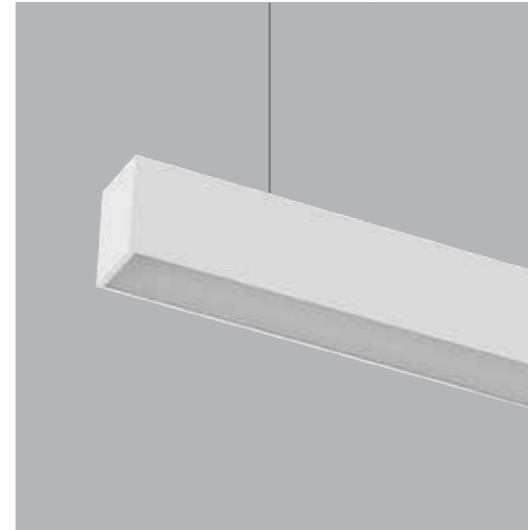

Model	Power	CRI	CCT	Beam Angle	LED Output	System Output	Dimming Type
KAS-LL02-62-A-D1-0620	20W	90	2700K	90°	1966lm	1515lm	ON-OFF 1-10V DALI
	20W	90	3000K	90°	2070lm	1595lm	ON-OFF 1-10V DALI
	20W	90	3500K	90°	2194lm	1691lm	ON-OFF 1-10V DALI
	20W	90	4000K	90°	2236lm	1723lm	ON-OFF 1-10V DALI

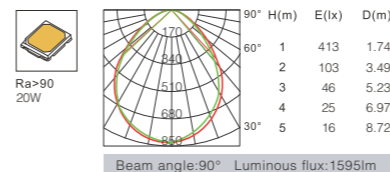

KAS-LL02-62-A-D1-1240

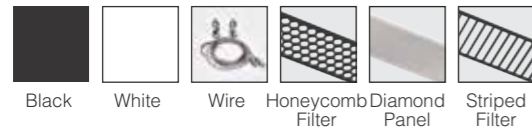
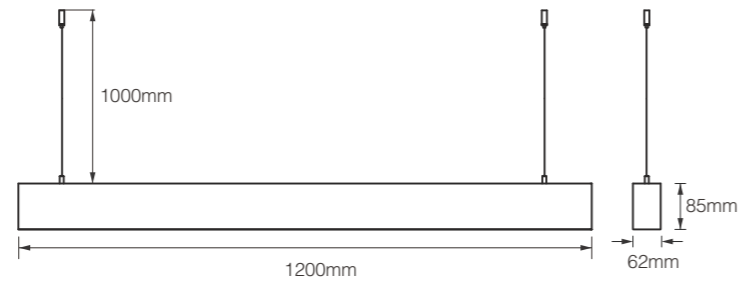
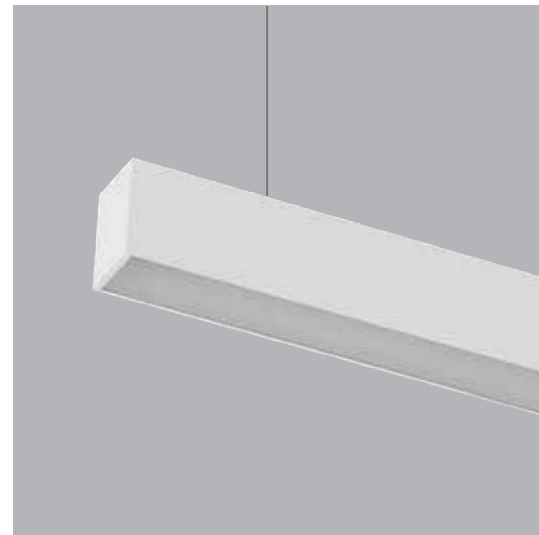

Model	Power	CRI	CCT	Beam Angle	LED Output	System Output	Dimming Type
 KAS-LL02-62-A-D1-1240	40W	90	2700K	90°	3743lm	3091lm	ON-OFF 1-10V DALI
	40W	90	3000K	90°	3940lm	3254lm	ON-OFF 1-10V DALI
	40W	90	3500K	90°	4176lm	3449lm	ON-OFF 1-10V DALI
	40W	90	4000K	90°	4255lm	3514lm	ON-OFF 1-10V DALI

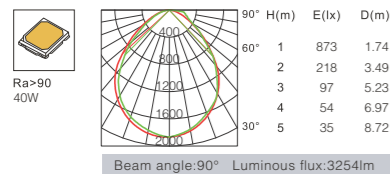

KAS-LL02-62-A-D1-1550

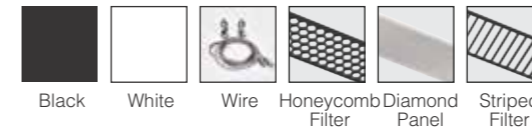
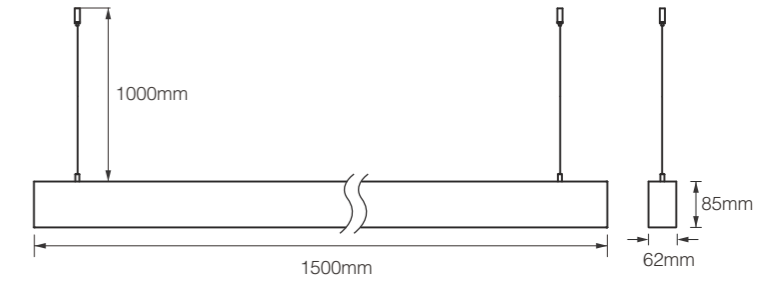
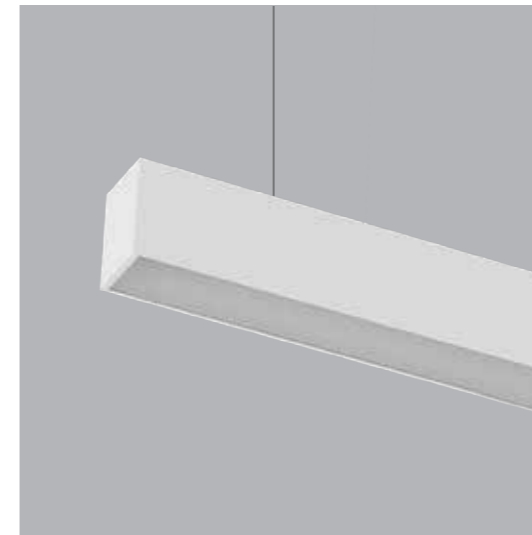

Model	Power	CRI	CCT	Beam Angle	LED Output	System Output	Dimming Type
 KAS-LL02-62-A-D1-1550	50W	90	2700K	90°	4720lm	3474lm	ON-OFF 1-10V DALI
	50W	90	3000K	90°	4968lm	3657lm	ON-OFF 1-10V DALI
	50W	90	3500K	90°	5266lm	3876lm	ON-OFF 1-10V DALI
	50W	90	4000K	90°	5365lm	3949lm	ON-OFF 1-10V DALI

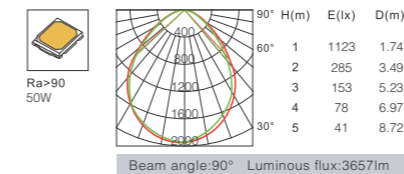

KAS-LL02-62-A-D1-2480

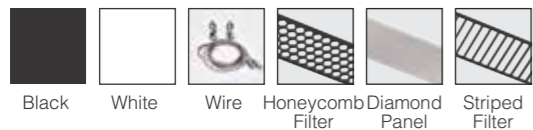
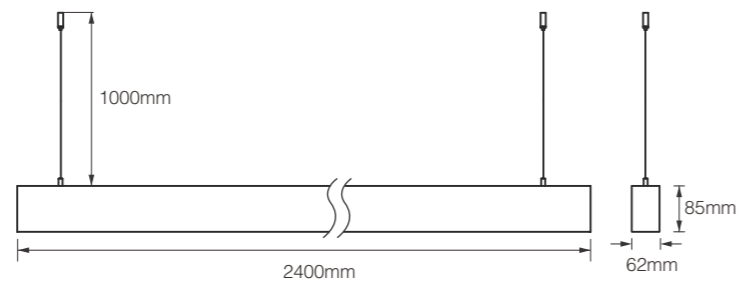
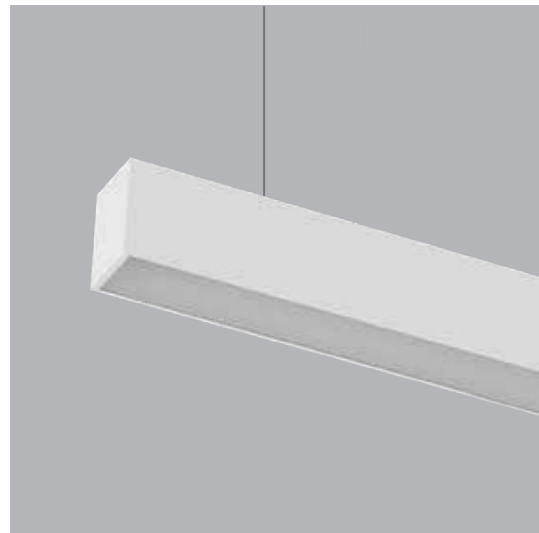

Model	Power	CRI	CCT	Beam Angle	LED Output	System Output	Dimming Type
KAS-LL02-62-A-D1-2480	80W	90	2700K	90°	7866lm	6325lm	ON-OFF 1-10V DALI
	80W	90	3000K	90°	8280lm	6658lm	ON-OFF 1-10V DALI
	80W	90	3500K	90°	8777lm	7057lm	ON-OFF 1-10V DALI
	80W	90	4000K	90°	8942lm	7190lm	ON-OFF 1-10V DALI

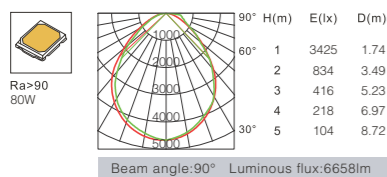

GLOW MODE



Down



Detail Pictures



Front detail



Back detail



Glow effect

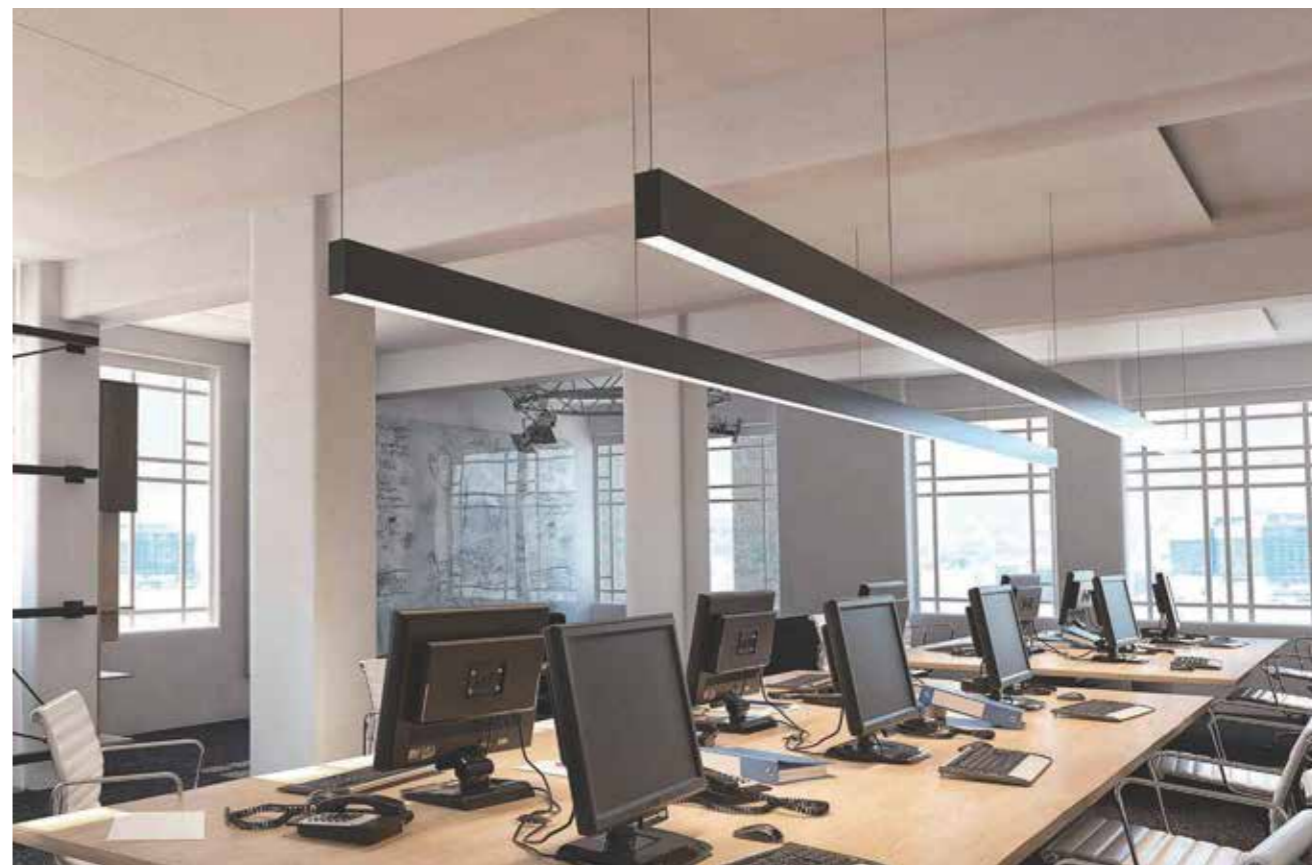

KAS-LL02-62-A-D1-0620DW

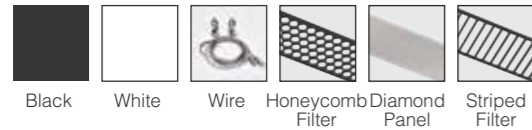
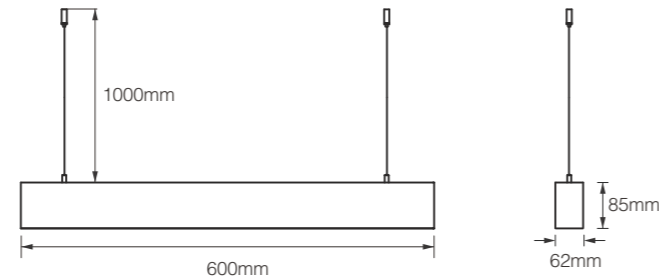
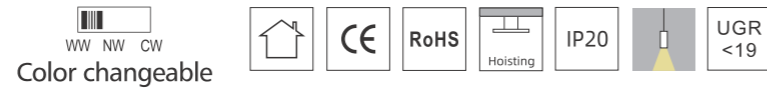
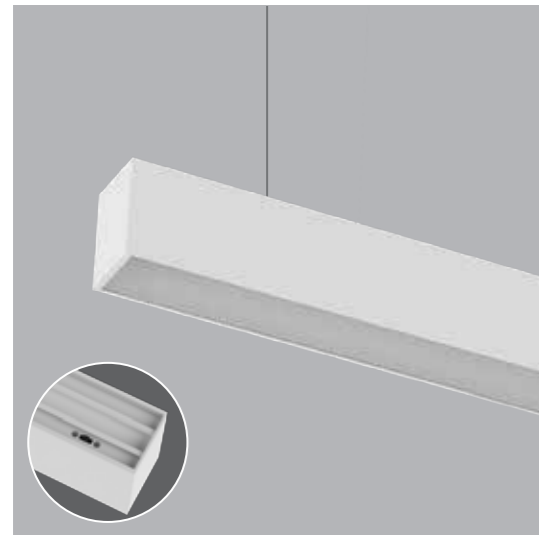

Model	Power	CRI	CCT	Beam Angle	LED Output	System Output	Dimming Type
KAS-LL02-62-A-D1-0620DW	20W	90	2700K	90°	1966lm	1515lm	ON-OFF 1-10V DALI
	20W	90	3000K	90°	2070lm	1595lm	ON-OFF 1-10V DALI
	20W	90	3500K	90°	2194lm	1691lm	ON-OFF 1-10V DALI
	20W	90	4000K	90°	2236lm	1723lm	ON-OFF 1-10V DALI

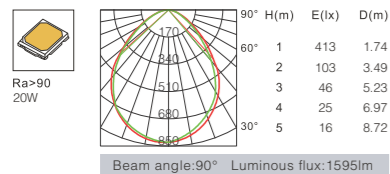

KAS-LL02-62-A-D1-1240DW

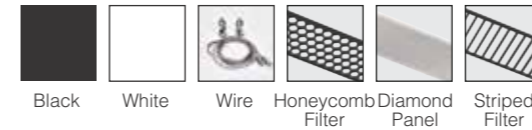
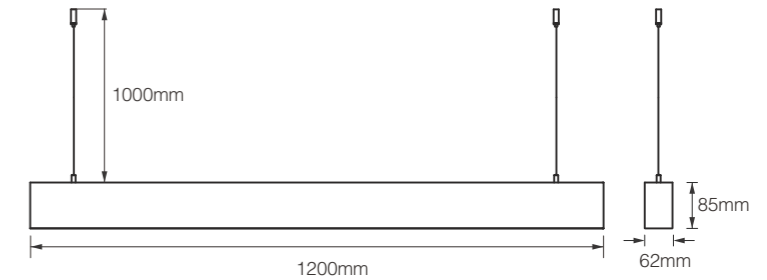

Model	Power	CRI	CCT	Beam Angle	LED Output	System Output	Dimming Type
KAS-LL02-62-A-D1-1240DW	40W	90	2700K	90°	3743lm	3091lm	ON-OFF 1-10V DALI
	40W	90	3000K	90°	3940lm	3254lm	ON-OFF 1-10V DALI
	40W	90	3500K	90°	4176lm	3449lm	ON-OFF 1-10V DALI
	40W	90	4000K	90°	4255lm	3514lm	ON-OFF 1-10V DALI

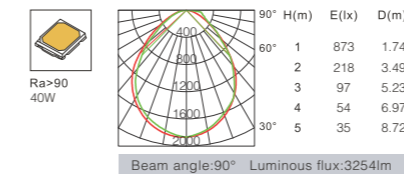

KAS-LL02-62-A-D1-1550DW

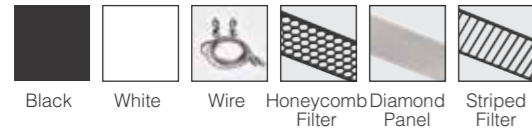
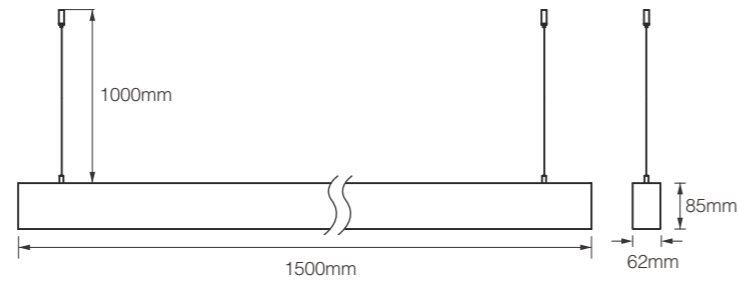
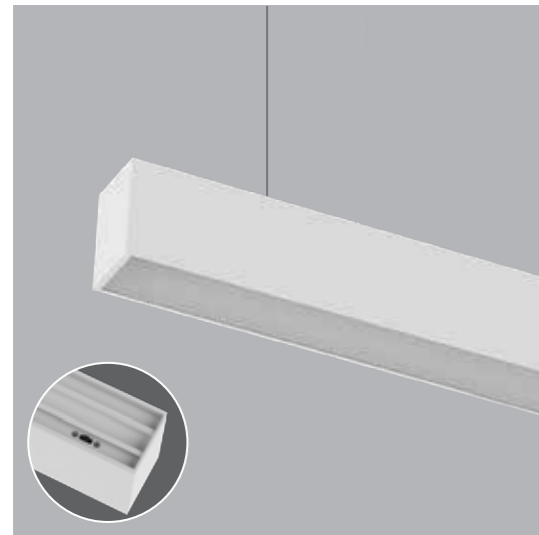

Model	Power	CRI	CCT	Beam Angle	LED Output	System Output	Dimming Type
KAS-LL02-62-A-D1-1550DW	50W	90	2700K	90°	4720lm	3474lm	ON-OFF 1-10V DALI
	50W	90	3000K	90°	4968lm	3657lm	ON-OFF 1-10V DALI
	50W	90	3500K	90°	5266lm	3876lm	ON-OFF 1-10V DALI
	50W	90	4000K	90°	5365lm	3949lm	ON-OFF 1-10V DALI

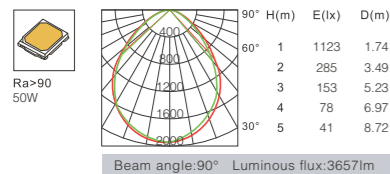

KAS-LL02-62-A-D1-2480DW

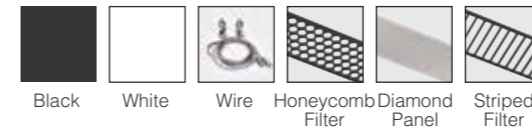
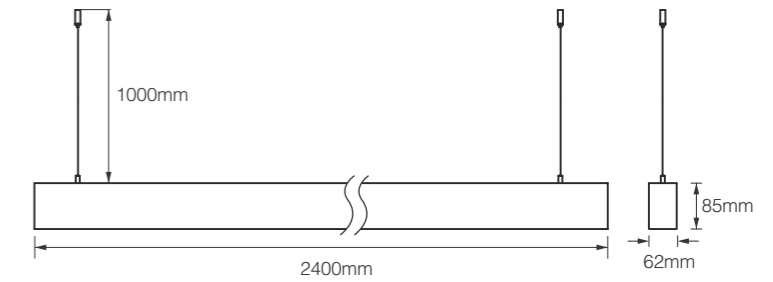
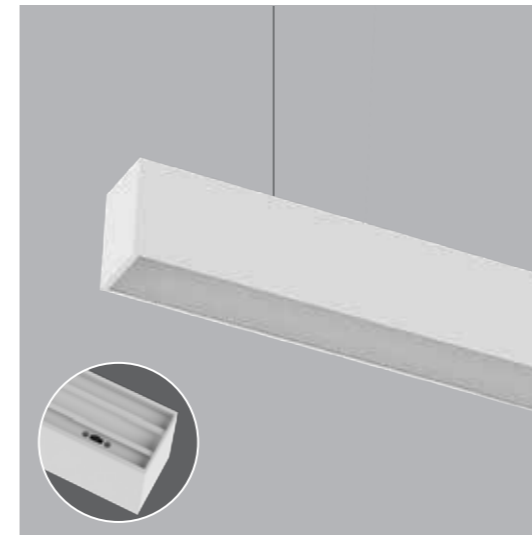

Model	Power	CRI	CCT	Beam Angle	LED Output	System Output	Dimming Type
KAS-LL02-62-A-D1-2480DW	80W	90	2700K	90°	7866lm	1914lm	ON-OFF 1-10V DALI
	80W	90	3000K	90°	8280lm	2015lm	ON-OFF 1-10V DALI
	80W	90	3500K	90°	8777lm	2136lm	ON-OFF 1-10V DALI
	80W	90	4000K	90°	8942lm	2176lm	ON-OFF 1-10V DALI

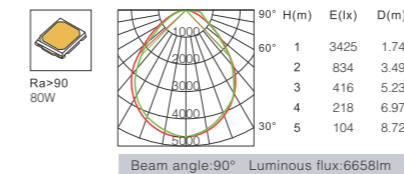

GLOW MODE



Up+down



Detail Pictures

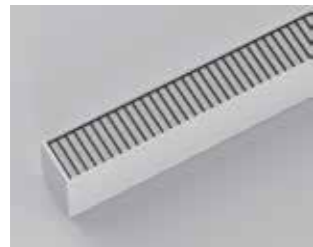

Front detail



Back detail



Glow effect



KAS-LL02-62-A-D2-0620

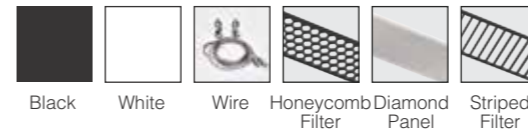
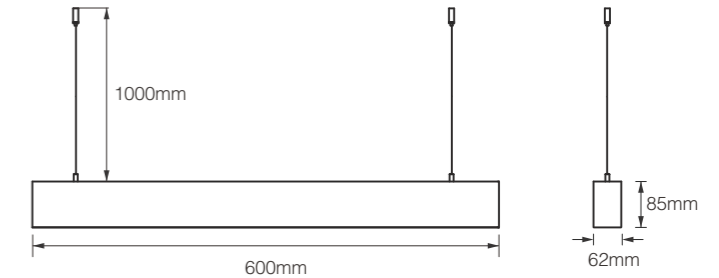
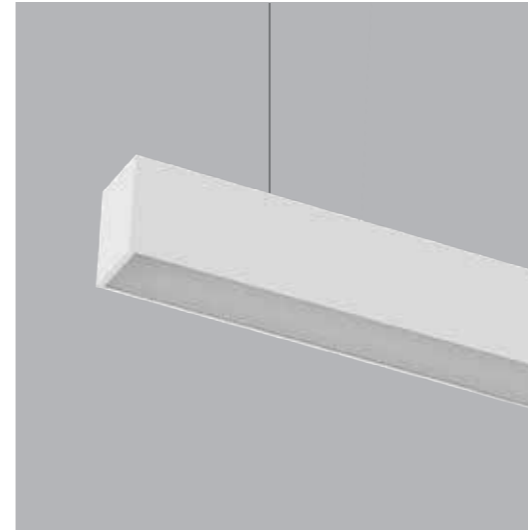

Model	Glow Direction	Power	CRI	CCT	Beam Angle	LED Output	System Output	Dimming Type
KAS-LL02-62-A-D2-0620 Up10W+Down20W	Up	10W	90	2700K	110°	983lm	689lm	ON-OFF 1-10V DALI
	Down	20W	90	2700K	90°	1966lm	1404lm	
ENERGY CLASS C	Up	10W	90	3000K	110°	1035lm	725lm	ON-OFF 1-10V DALI
	Down	20W	90	3000K	90°	2070lm	1478lm	
	Up	10W	90	3500K	110°	1097lm	769lm	ON-OFF 1-10V DALI
	Down	20W	90	3500K	90°	2194lm	1567lm	
	Up	10W	90	4000K	110°	1118lm	783lm	ON-OFF 1-10V DALI
	Down	20W	90	4000K	90°	2236lm	1596lm	

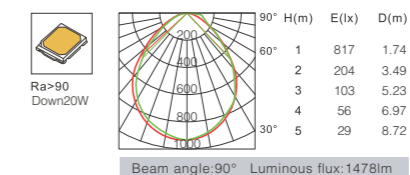
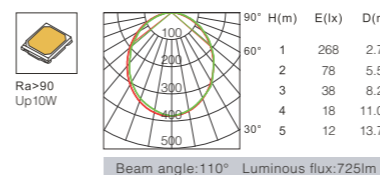

KAS-LL02-62-A-D2-1240

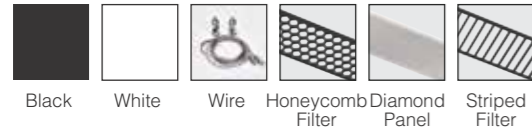
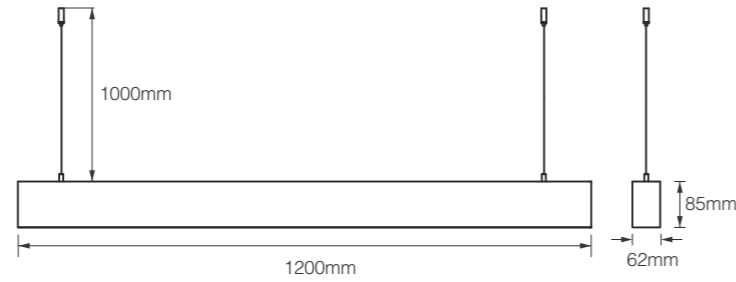
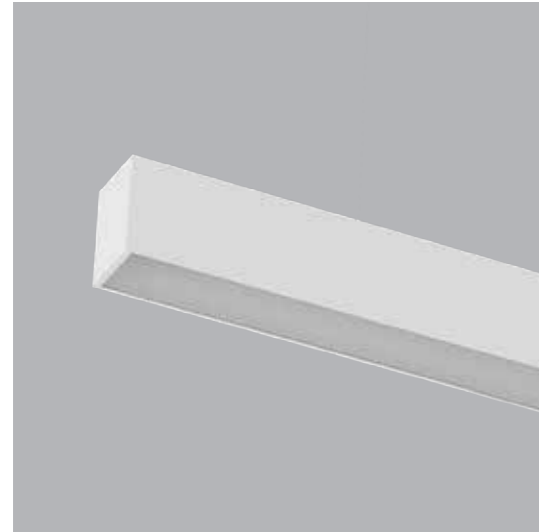

Model	Glow Direction	Power	CRI	CCT	Beam Angle	LED Output	System Output	Dimming Type
KAS-LL02-62-A-D2-1240 Up20W+Down40W	Up	20W	90	2700K	110°	1966lm	1449lm	ON-OFF 1-10V DALI
	Down	40W	90	2700K	90°	3743lm	2579lm	
ENERGY CLASS C	Up	20W	90	3000K	110°	2070lm	1525lm	ON-OFF 1-10V DALI
	Down	40W	90	3000K	90°	3940lm	2715lm	
ENERGY CLASS C	Up	20W	90	3500K	110°	2196lm	1616lm	ON-OFF 1-10V DALI
	Down	40W	90	3500K	90°	4176lm	2878lm	
ENERGY CLASS C	Up	20W	90	4000K	110°	2236lm	1647lm	ON-OFF 1-10V DALI
	Down	40W	90	4000K	90°	4255lm	2932lm	

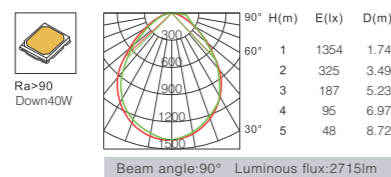
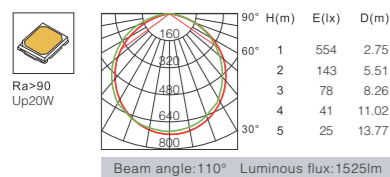

KAS-LL02-62-A-D2-1550

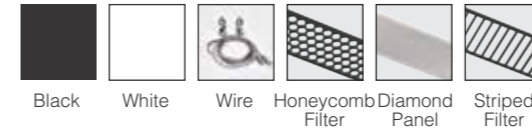
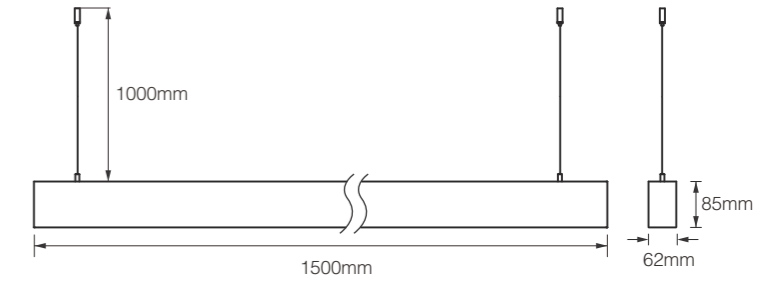
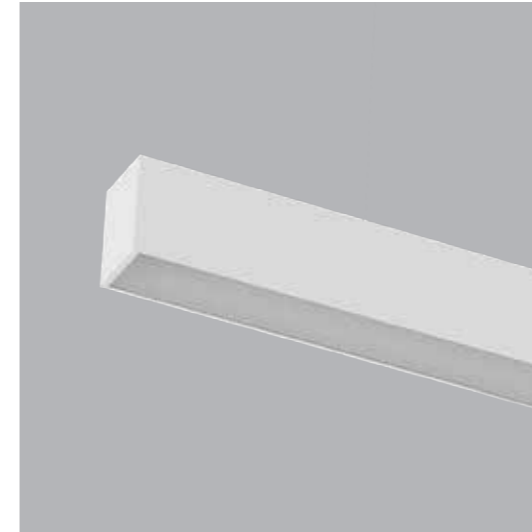

Model	Glow Direction	Power	CRI	CCT	Beam Angle	LED Output	System Output	Dimming Type
KAS-LL02-62-A-D2-1550 Up25W+Down50W	Up	25W	90	2700K	110°	2360lm	1655lm	ON-OFF 1-10V DALI
	Down	50W	90	2700K	90°	4720lm	3217lm	
ENERGY CLASS C	Up	25W	90	3000K	110°	2484lm	1742lm	ON-OFF 1-10V DALI
	Down	50W	90	3000K	90°	4968lm	3387lm	
ENERGY CLASS C	Up	25W	90	3500K	110°	2633lm	1846lm	ON-OFF 1-10V DALI
	Down	50W	90	3500K	90°	5266lm	3590lm	
ENERGY CLASS C	Up	25W	90	4000K	110°	2683lm	1881lm	ON-OFF 1-10V DALI
	Down	50W	90	4000K	90°	5365lm	3658lm	

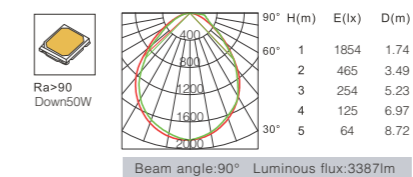
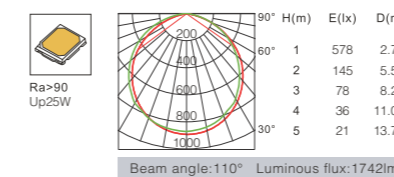

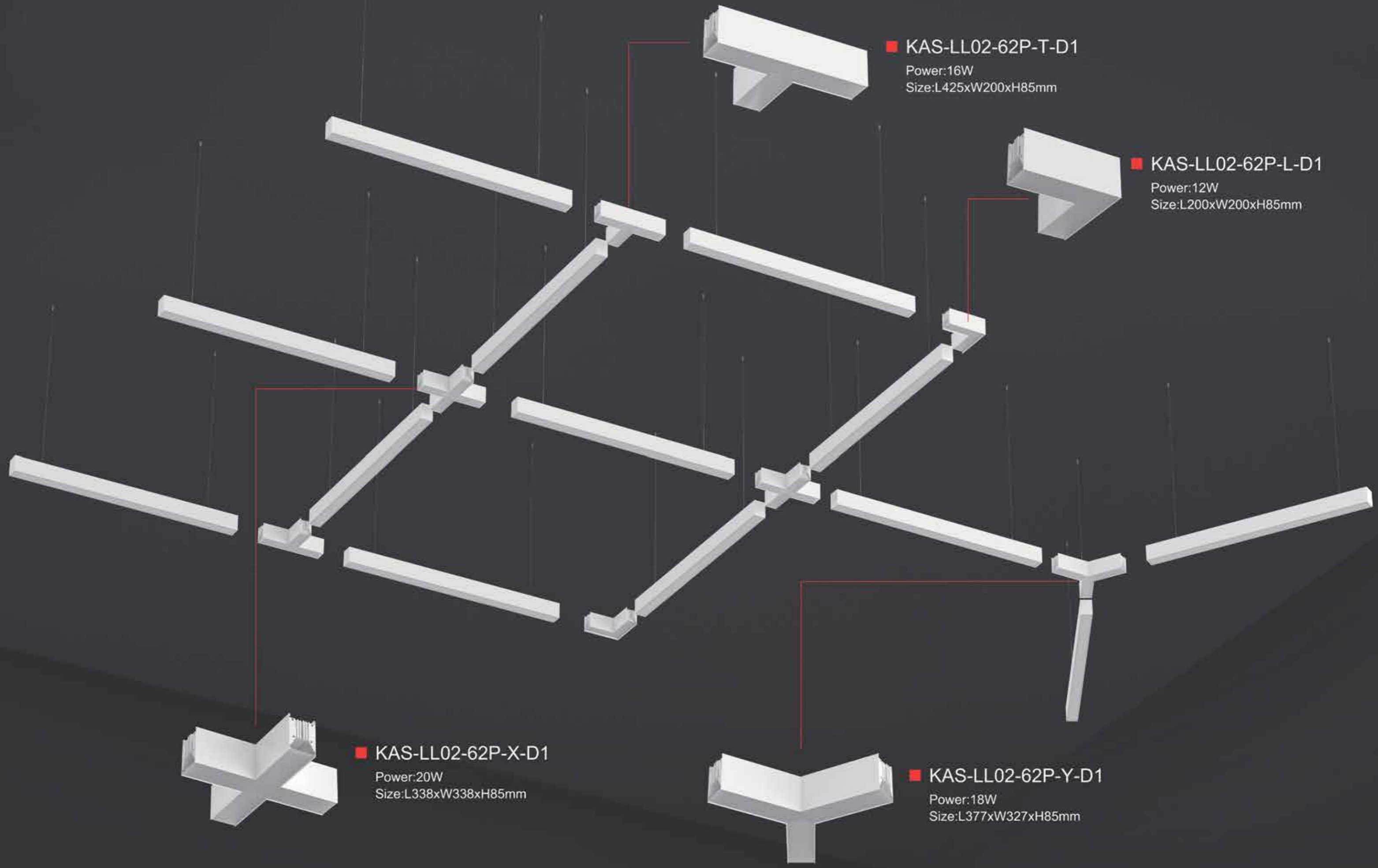

■ KAS-LL02-62P-T-D1
Power:16W
Size:L425xW200xH85mm

■ KAS-LL02-62P-L-D1
Power:12W
Size:L200xW200xH85mm

■ KAS-LL02-62P-X-D1
Power:20W
Size:L338xW338xH85mm

■ KAS-LL02-62P-Y-D1
Power:18W
Size:L377xW327xH85mm

KAS-LL02-62P-L-D1

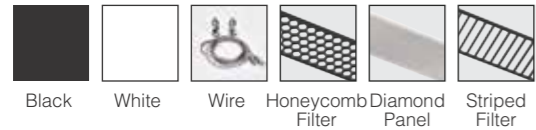
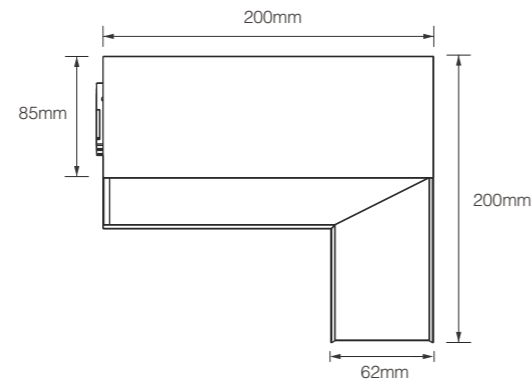

Model	Power	CRI	CCT	Beam Angle	LED Output	System Output	Dimming Type
KAS-LL02-62P-L-D1	12W	90	2700K	90°	1180lm	783lm	ON-OFF 1-10V DALI
	12W	90	3000K	90°	1242lm	824lm	ON-OFF 1-10V DALI
	12W	90	3500K	90°	1316lm	873lm	ON-OFF 1-10V DALI
	12W	90	4000K	90°	1341lm	890lm	ON-OFF 1-10V DALI

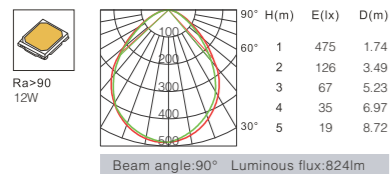

KAS-LL02-62P-X-D1

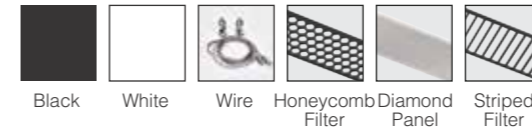
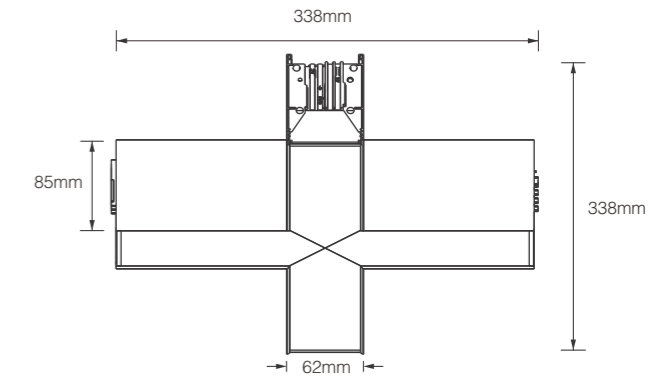
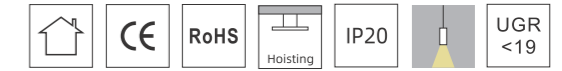
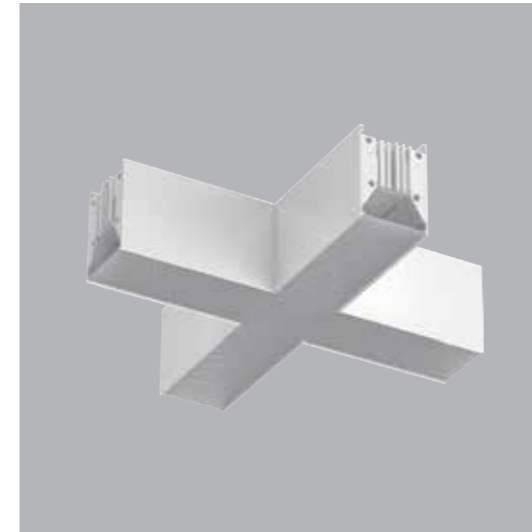

Model	Power	CRI	CCT	Beam Angle	LED Output	System Output	Dimming Type
KAS-LL02-62P-X-D1	20W	90	2700K	90°	1966lm	1290lm	ON-OFF 1-10V DALI
	20W	90	3000K	90°	2070lm	1358lm	ON-OFF 1-10V DALI
	20W	90	3500K	90°	2196lm	1439lm	ON-OFF 1-10V DALI
	20W	90	4000K	90°	2236lm	1467lm	ON-OFF 1-10V DALI

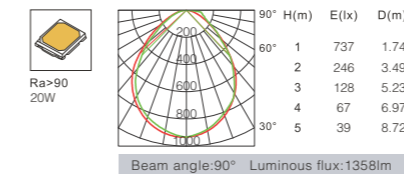

KAS-LL02-62P-Y-D1

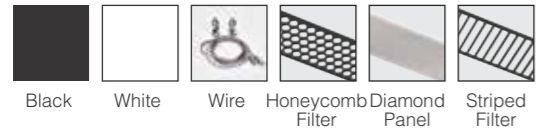
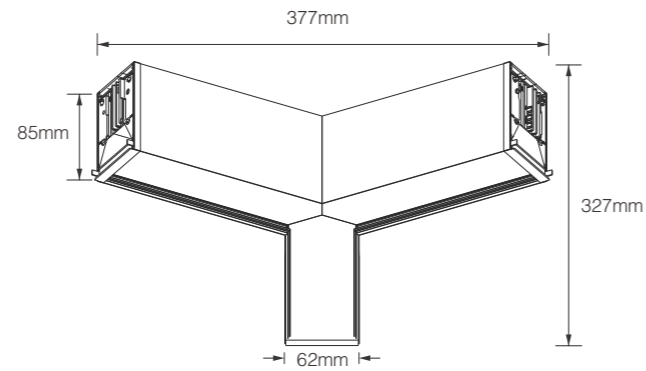

Model	Power	CRI	CCT	Beam Angle	LED Output	System Output	Dimming Type
KAS-LL02-62P-Y-D1	18W	90	2700K	90°	1770lm	1220lm	ON-OFF 1-10V DALI
	18W	90	3000K	90°	1863lm	1285lm	ON-OFF 1-10V DALI
	18W	90	3500K	90°	1975lm	1362lm	ON-OFF 1-10V DALI
	18W	90	4000K	90°	2012lm	1388lm	ON-OFF 1-10V DALI

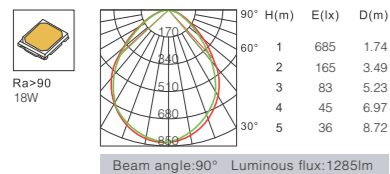

KAS-LL02-62P-T-D1

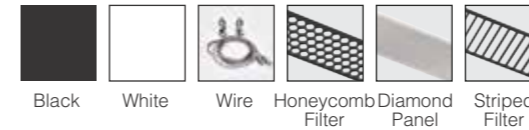
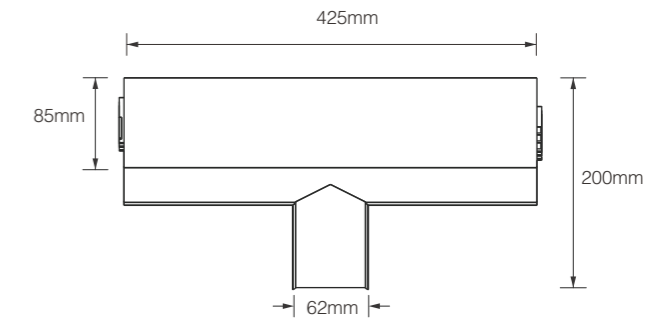

Model	Power	CRI	CCT	Beam Angle	LED Output	System Output	Dimming Type
KAS-LL02-62P-T-D1	16W	90	2700K	90°	1377lm	1000lm	ON-OFF 1-10V DALI
	16W	90	3000K	90°	1449lm	1053lm	ON-OFF 1-10V DALI
	16W	90	3500K	90°	1536lm	1116lm	ON-OFF 1-10V DALI
	16W	90	4000K	90°	1565lm	1137lm	ON-OFF 1-10V DALI

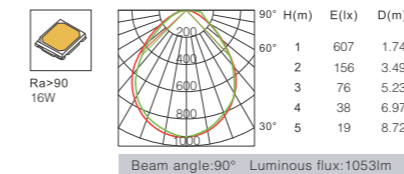

connect



IINNO Ltd
Unit 7, 8/F, Tower B
83 King Lam Street
Lai Chi Kok, Kowloon
Hong Kong
Tel: +86 (0)769 2301 0151 / 2
WhatsApp: +86 139 2290 5402
Email: sales@iinno-lighting.com
Web: www.iinno-lighting.com

